

# Cjenik VELUX proizvoda

Cijene vrijede od 19.03.2024.

# Dimenzije

Sve navedene dimenzije odnose se na vanjski okvir prozora, a ne na površinu stakla (š x d u mm).

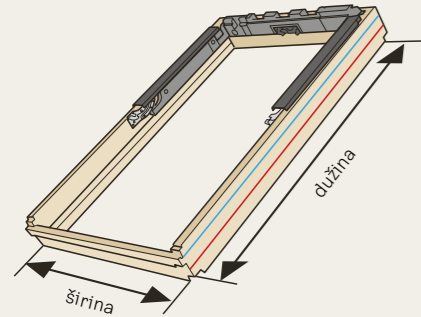

model VELUX krovnog prozora

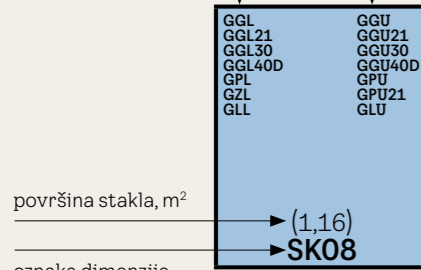

oznaka dimenzije VELUX krovnog prozora

550				GGL GGL21 GGL30 (0,27) <b>PK25</b>			
624			GGL	(0,26) <b>MK27</b>			
698	GGL GGL21				GGL GGL21 GGL30	(0,48) <b>SK01</b>	
778	GGL21 GGL30 GGL40D GGL21 GGL30 GGL40D GGL21 GGL30 GGL40D (0,22) <b>CK02</b>						
978	GGL GGL21 GGL30 GGL40D GGL21 GGL30 GGL40D GGL21 GGL30 GGL40D (0,23) <b>BK04</b>	GGL GGL21 GGL30 GGL40D GGL21 GGL30 GGL40D GGL21 GGL30 GGL40D (0,29) <b>CK04</b>	GGL GGL21 GGL30 GGL40D GGL21 GGL30 GGL40D GGL21 GGL30 GGL40D (0,38) <b>FK04</b>	GGL GGL21 GGL30 GGL40D GGL21 GGL30 GGL40D GGL21 GGL30 GGL40D (0,47) <b>MK04</b>	GGL GGL21 GGL30 GGL40D GGL21 GGL30 GGL40D GGL21 GGL30 GGL40D (0,60) <b>PK04</b>		GGL GGL21 GGL30 GGL40D GGL21 GGL30 GGL40D GGL21 GGL30 GGL40D (0,91) <b>UK04</b>
1178	GGL GGL21 GGL30 GGL40D GGL21 GGL30 GGL40D GGL21 GGL30 GGL40D (0,37) <b>CK06</b>	GGL GGL21 GGL30 GGL40D GGL21 GGL30 GGL40D GGL21 GGL30 GGL40D (0,47) <b>FK06</b>	GGL GGL21 GGL30 GGL40D GGL21 GGL30 GGL40D GGL21 GGL30 GGL40D (0,59) <b>MK06</b>	GGL GGL21 GGL30 GGL40D GGL21 GGL30 GGL40D GGL21 GGL30 GGL40D (0,75) <b>PK06</b>	GGL GGL21 GGL30 GGL40D GGL21 GGL30 GGL40D GGL21 GGL30 GGL40D (0,95) <b>SK06</b>		GGL GGL21 GGL30 GGL40D GGL21 GGL30 GGL40D GGL21 GGL30 GGL40D (1,15) <b>UK06</b>
1398	GGL GGL21 GGL30 GGL40D GGL21 GGL30 GGL40D GGL21 GGL30 GGL40D (0,58) <b>FK08</b>	GGL GGL21 GGL30 GGL40D GGL21 GGL30 GGL40D GGL21 GGL30 GGL40D (0,72) <b>MK08</b>	GGL GGL21 GGL30 GGL40D GGL21 GGL30 GGL40D GGL21 GGL30 GGL40D (0,92) <b>PK08</b>	GGL GGL21 GGL30 GGL40D GGL21 GGL30 GGL40D GGL21 GGL30 GGL40D (1,16) <b>SK08</b>	GGL GGL21 GGL30 GGL40D GGL21 GGL30 GGL40D GGL21 GGL30 GGL40D (1,40) <b>UK08</b>		
1600			GGL GGL21 GGL30 GGL40D GGL21 GGL30 GGL40D GGL21 GGL30 GGL40D (0,85) <b>MK10</b>	GGL GGL21 GGL30 GGL40D GGL21 GGL30 GGL40D GGL21 GGL30 GGL40D (1,07) <b>PK10</b>	GGL GGL21 GGL30 GGL40D GGL21 GGL30 GGL40D GGL21 GGL30 GGL40D (1,35) <b>SK10</b>	GGL GGL21 GGL30 GGL40D GGL21 GGL30 GGL40D GGL21 GGL30 GGL40D (1,63) <b>UK10</b>	
1800			GGL GGL21 (0,97) <b>MK12</b>				
920		GIL GIU	GIL GIU	GIL GIU	GIL GIU	GIL GIU	GIL GIU
		(0,34) <b>MK34</b>	(0,44) <b>PK34</b>	(0,70) <b>SK34</b>	(0,85) <b>UK34</b>		
601		VFE VFA VFB	VIU VFA VFB	VFE VFA VFB	VIU VFA VFB	VFE VFA VFB	VIU VFA VFB
		(0,22) <b>MK31</b>	(0,28) <b>PK31</b>	(0,36) <b>SK31</b>	(0,43) <b>UK31</b>		
955		VFE VFA VFB	VIU VFA VFB	VFE VFA VFB	VIU VFA VFB	VFE VFA VFB	VIU VFA VFB
		(0,44) <b>MK35</b>	(0,56) <b>PK35</b>	(0,70) <b>SK35</b>	(0,85) <b>UK35</b>		
1155		VFE VFA VFB	VIU VFA VFB	VFE VFA VFB	VIU VFA VFB	VFE VFA VFB	VIU VFA VFB
		(0,56) <b>MK36</b>	(0,71) <b>PK36</b>	(0,89) <b>SK36</b>	(1,08) <b>UK36</b>		
1375		VFE VFA VFB	VIU VFA VFB	VFE VFA VFB	VIU VFA VFB	VFE VFA VFB	VIU VFA VFB
		(0,69) <b>MK38</b>	(0,87) <b>PK38</b>	(1,10) <b>SK38</b>	(1,33) <b>UK38</b>		
mm	472	550	660	780	942	1140	1340

Vrijednost u zagradama označava površinu stakla prozora u m<sup>2</sup>

## Krovni balkon GDL

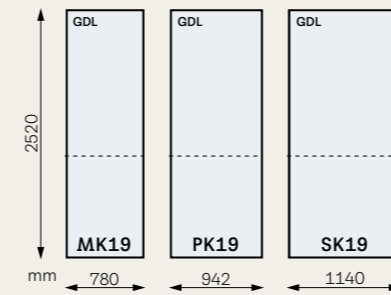

## Krovna terasa GEL

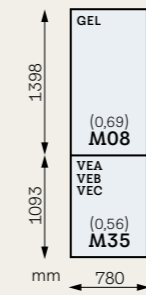

## VELUX GGLS 3u1

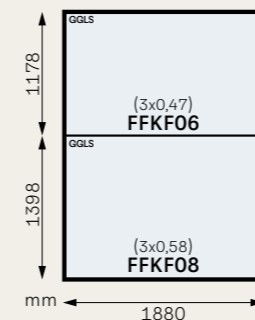

## Izlazi na krov

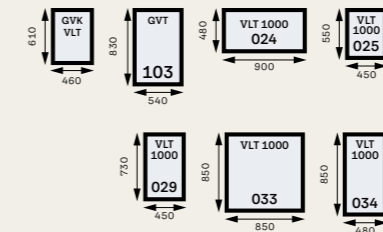

## Prozori za ravni krov

600	CFP CVP CVU 060060	CFJ CVJ CVU 090060		CFU CVU 200060			
800	CFP CVP CVU 080080	CFJ CVJ CVU 090080		CFU CVU 150080			
900	CFP CVP CVU 060090	CFJ CVJ CVU 090090	CFI CVI CVU 120090	CFU CVU 200100			
1000		CFP CVP CVU 100100	CFJ CVJ CVU 120100	CFU CVU 150100			
1200		CFP CVP CVU 090120	CFJ CVJ CVU 120120	CFU CVU 150120			
1500		CFP CVP CVU 100150	CFJ CVJ CVU 120150	CFU CVU 150150			
mm	600	800	900	1000	1200	1500	2000

■ Nova generacija VELUX prozora za ravni krov  
 ■ VELUX prozor za ravni krov s kupolom  
 ■ Kupole

## Svjetlosni tuneli

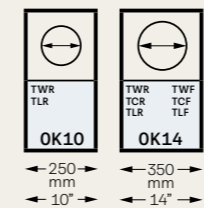

# Sadržaj

Karakteristike stakla	4
Pregled kombiniranih opšava	6
Krovni prozori	8
Pojedinačni opšavi	18
Kombinirani opšavi	22
VELUX vertikalni elementi	30
Space makers	38
Setovi	44
Rješenja za ugradnju	46
Unutarnja sjenila	50
Komarnik	56
Vanjske rolete	58
Električni proizvodi i dodatna oprema	62
Izlazi na krov	64
Zamjenska stakla	66
Svjetlosni tuneli	68
Prozori za ravni krov	70
Sustavi za odimljavanje	78

Kod svih VELUX krovni prozora aluminijski profil koriste se kao standard. Dodatne opcije (bakar i titan-cink) dostupne su za neke proizvode – molimo pogledajte dostupne proizvode. Za više informacija molimo kontaktirajte VELUX službu za korisnike.

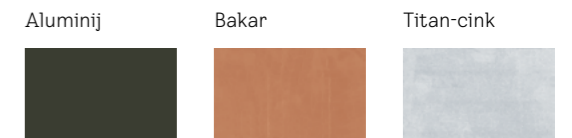

Vanjski profil	Model
<b>Premium krovni prozori</b>	
Bakar	GGL, GGU, GPL, GPU, GDL, GEL, VEA, VEB, VEC
Titan-cink	GGL, GGU, GPL, GPU, GDL, GEL, VEA, VEB, VEC
<b>Opšavi</b>	
Bakar	Pojedinačni i kombinirani opšavi
Titan-cink	Pojedinačni i kombinirani opšavi

# Karakteristike stakla

	Standard	Standard Plus
<b>Staklo</b>	<b>51</b>	<b>61</b>
	<b>DVOSTRUKO STAKLO</b>	<b>UŠTEDA ENERGIJE</b>
Trostruko staklo		✓
Toplinska izolacija		✓
Zvučna izolacija		✓
Smanjenje buke kiše		
Sigurnost		
Kaljeno staklo	✓	✓
UV filter		
Easy-to-clean		
Premaz protiv rošenja		
<b>U<sub>w</sub></b> Toplinska izolacija (za prozor) (W/m <sup>2</sup> K)	<b>1,3</b>	<b>1,1</b>
<b>U<sub>g</sub></b> Toplinska izolacija (za staklo) (W/m <sup>2</sup> K)	<b>1,0</b>	<b>0,6</b>
<b>g</b> Dobitak sunčeve energije	<b>0,46</b>	<b>0,50</b>
<b>R<sub>w</sub></b> Zvučna izolacija (dB)	<b>31</b>	<b>32</b>
Zrakopropusnost	<b>3</b>	<b>4</b>
Punjenje plinom	<b>Argon</b>	<b>Argon</b>
<b>T<sub>v</sub></b> Propusnost za svjetlo	<b>0,69</b>	<b>0,68</b>
<b>T<sub>uv</sub></b> UV propusnost	<b>0,22</b>	<b>0,22</b>
Zaštita od provala	-	-
Razina sigurnosti	-	-
Struktura stakla	4 mm plutajuće staklo 16 mm Argon 4 mm kaljeno staklo	4 mm plutajuće staklo 15 mm Argon 3 mm toplinski ojačano staklo 15 mm Argon 3 mm kaljeno staklo

\* VELUX GGLS 3u1, GDL, GEL/VEA/VEB/VEC: kontaktirajte VELUX službu za korisnike za tehničke parametre.  
\*\* GGL/GGU: U<sub>w</sub> = 0,92, daljinski upravljani GGL/GGU/GPU: U<sub>w</sub> = 0,96, GIL/GIU/VFE/VIU: U<sub>w</sub> = 1,0 (W/m<sup>2</sup>K)

Premium				
<b>70</b>	<b>70Q</b>	<b>68</b>	<b>66</b>	<b>62</b>
<b>SIGURNOST I SMANJENJE BUKE KIŠE</b>	<b>PROTUPROVALNO STAKLO</b>	<b>UŠTEDA ENERGIJE I SIGURNOST</b>	<b>UŠTEDA ENERGIJE I EASY-TO-CLEAN</b>	<b>UŠTEDA ENERGIJE I SMANJENJE BUKE</b>
		✓	✓	✓
✓	✓	✓	✓	✓
✓	✓	✓	✓	✓
✓	✓	✓	✓	✓
✓	✓	✓	✓	✓
			✓	
			✓	✓
<b>1,3</b>	<b>1,3</b>	<b>1,1</b>	<b>1,0</b>	<b>0,96</b>
<b>1,0</b>	<b>1,0</b>	<b>0,7</b>	<b>0,6</b>	<b>0,5</b>
<b>0,46</b>	<b>0,45</b>	<b>0,49</b>	<b>0,44</b>	<b>0,47</b>
<b>35</b>	<b>35</b>	<b>35</b>	<b>37</b>	<b>42</b>
<b>4</b>	<b>4</b>	<b>4</b>	<b>4</b>	<b>4</b>
<b>Argon</b>	<b>Argon</b>	<b>Argon</b>	<b>Argon</b>	<b>Kripton</b>
<b>0,68</b>	<b>0,68</b>	<b>0,68</b>	<b>0,62</b>	<b>0,68</b>
<b>0,05</b>	<b>0,05</b>	<b>0,05</b>	<b>0,05</b>	<b>0,05</b>
<b>P2A</b>	<b>P4A</b>	<b>P2A</b>	<b>P2A</b>	<b>P2A</b>
<b>1B1</b>	<b>1B1</b>	<b>1B1</b>	<b>1B1</b>	<b>1B1</b>
6.8 mm laminirano plutajuće staklo 16 mm Argon 4 mm kaljeno staklo	7.5 mm laminirano plutajuće staklo 16 mm argon 4 mm kaljeno staklo	6.8 mm laminirano plutajuće staklo 13 mm Argon 3 mm toplinski ojačano staklo 13 mm Argon 4 mm kaljeno staklo	6.8 mm laminirano plutajuće staklo 13 mm Argon 3 mm toplinski ojačano staklo 13 mm Argon 4 mm kaljeno staklo	6.8 mm laminirano plutajuće staklo 11 mm Kripton 3 mm toplinski ojačano staklo 11 mm Kripton 8 mm kaljeno staklo

## Prednosti



**Toplinska izolacija**  
Zaboravite na vanjske vremenske uvjete i uživajte u ugodnoj unutarnjoj temperaturi. Niži broj U<sub>w</sub> znači bolju izolaciju.



**Zvučna izolacija**  
Što manje buke iz vana, više mira i udobnosti u vašem domu. Veći broj R<sub>w</sub> znači bolju izolaciju.



**Smanjenje buke kiše**  
Uživajte u mirnom snu bez buke kišnih kapi koje udaraju o prozorsko staklo.



**Laminirano sigurnosno staklo**  
Unutarnje staklo je laminirano pa se u slučaju loma ne raspršuje po prostoru.



**Kaljeno staklo**  
Povećana čvrstoća vanjskog stakla štiti od ekstremnih vremenskih uvjeta poput jakih oluja i tuče.



**UV filter**  
Štiti boje interijera i namještaja od blijedenja izazvanog sunčevim UV zrakama.



**Easy-to-clean premaz**  
Zaštitni premaz omogućuje vam da provedete manje vremena čisteći i više vremena uživajući u pogledu prema van.



**Premaz protiv rošenja**  
Zaštitni premaz smanjuje količinu rose koja može nastati na vanjskoj površini za jasniji pogled.

# Pregled kombiniranih opšava

Sustav elemenata koji omogućava kombinaciju više krovnih prozora.

Za krovne prozore GZL, GZL B, GLL, GLL B, GLU, GPL, GPU, GGL, GGU, GTL, GXL.

- VELUX preuzima vodeću poziciju u kvaliteti ugradnje i postavlja novi standard proizvoda za kombiniranu ugradnju
- Nova fleksibilna uvala pojednostavljuje ugradnju i eliminira rizik od naručivanja neispravne širine uvale, te smanjuje potrebu za dugotrajnim mjerenjima.
- VELUX fleksibilna uvala dio je standardne ugradnje EKW, EKS, EKE, EKQ opšava. Standardna udaljenost okvira „a“ između elemenata može biti 10–16 cm.
- Vrste fleksibilne uvale su EKT, EKB. Standardna udaljenost okvira „a“ između elemenata može biti E=10cm, F=12cm, G=14cm, H=16cm.
- Jedan iznad drugoga: udaljenost između okvira „b“ za prozore bez vanjskih roleta 10 cm, za prozore s vanjskim roletama 25 cm.
- Jedan do drugog i jedan iznad drugog: zadnja znamenka koda označava položaj elementa na krovu.

## Krovni prozori jedan pored drugog

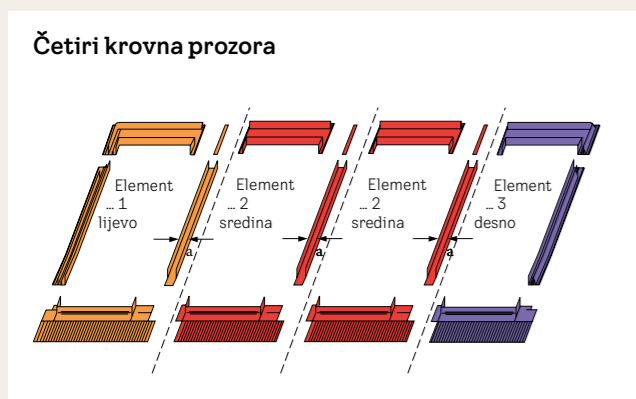
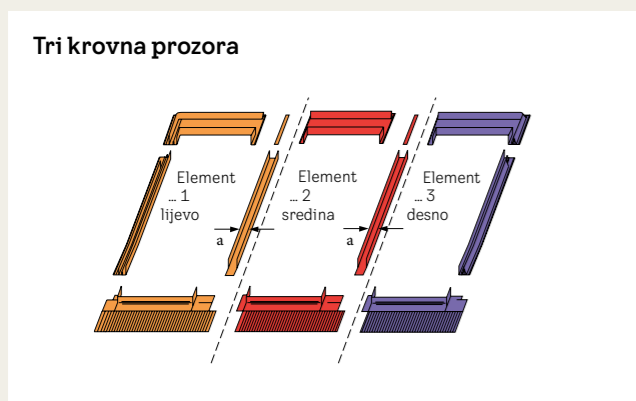
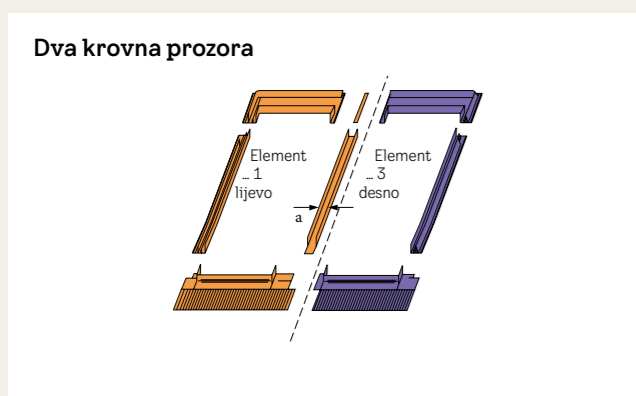

## Krovni prozori jedan iznad drugog

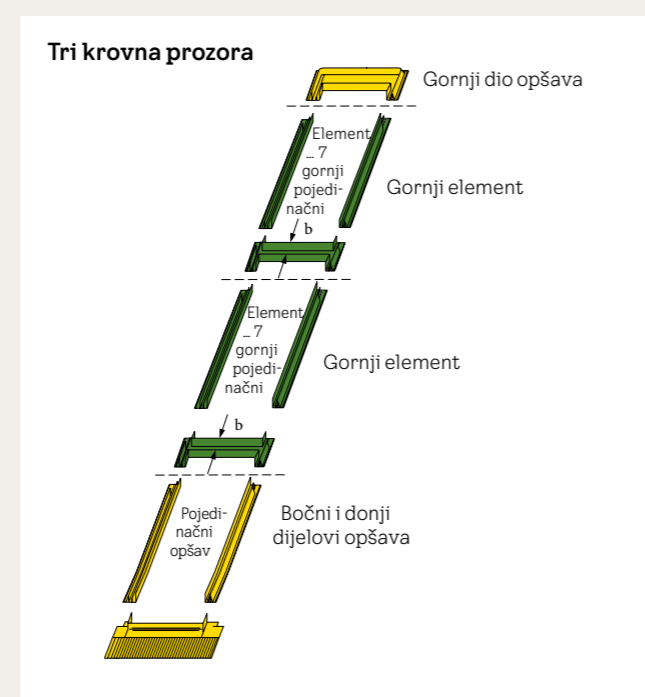
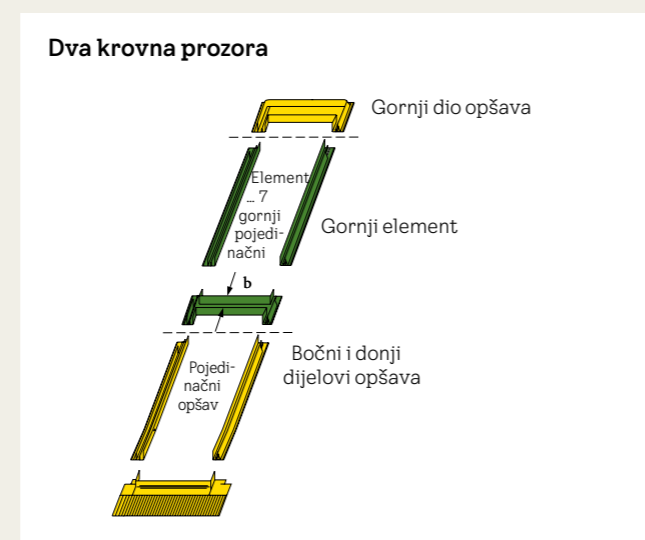

## VELUX kombinacija

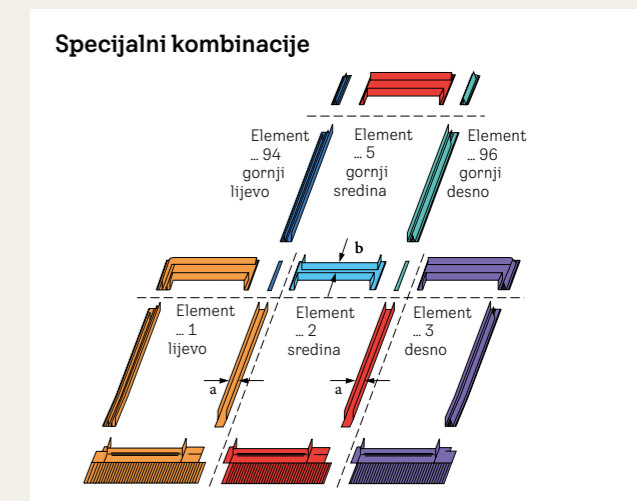
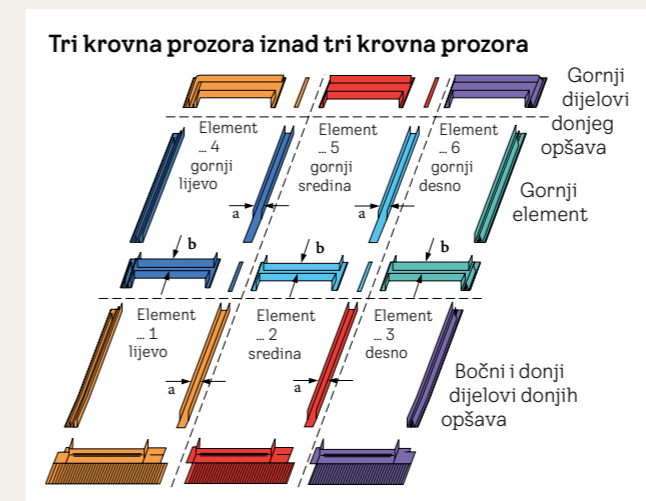
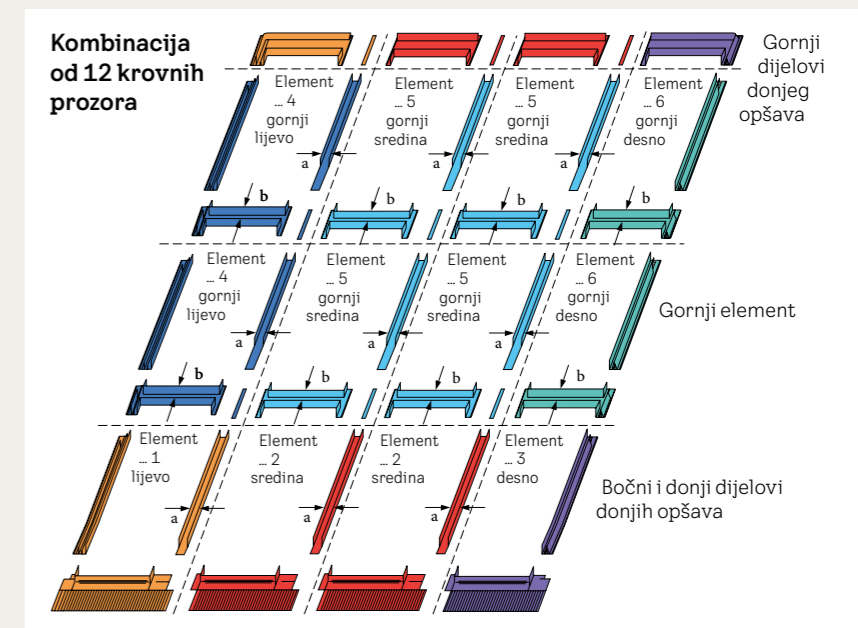
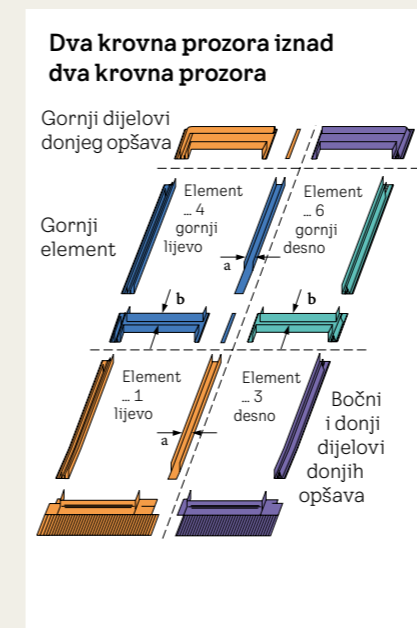

## Savjeti

- Položaj elemenata uvijek se određuje s vanjske strane.
- Udaljenost između okvira „a“ (jedan pored drugog) iznosi 10, 12, 14 ili 16 cm, opšavi dostupni po istoj cijeni.
- Fleksibilna uvala može se prilagoditi na širine od 100 do 160 mm.
- Razmak između okvira u čistom „b“ (jedan prozor iznad drugog) standardno je 10 cm za prozore bez roleta, a u slučaju prozora s vanjskim roletama – 25 cm.
- Svi krovni prozori smješteni jedan pored drugog moraju biti iste dužine.
- Svi prozori jedan iznad drugog moraju biti iste širine.

Širina prozora (cm)	55 (C--)	66 (F--)	78 (M--)	94 (P--)	114 (S--)	134 (U--)
Preporučeni razmak rogova (u cm) za krovne prozor s BDx setom	59–61	70–72	82–84	98–100	118–120	138–140

# KROVNI PROZORI ZA KOSI KROV



Cijena bez PDV-a (€)  
Cijena s PDV-om (€)

CKO2 55x78	CKO4 55x98	FKO4 66x98	FKO6 66x118	FKO8 66x140	MKO4 78x98	MKO6 78x118	MKO8 78x140	MK10 78x160	PKO6 94x118	PKO8 94x140	SKO6 114x118	SKO8 114x140

		W/(m <sup>2</sup> K)		Nagib krova														
<b>GZL 1051</b>	Ručno upravljanje, s gornjom ručkom, borovo drvo, završno premazano u dva sloja, prozirni lak, dvostruko staklo	1.3	15-90	229,60 <b>287,00</b>	244,80 <b>306,00</b>	272,00 <b>340,00</b>	284,00 <b>355,00</b>	311,20 <b>389,00</b>	277,60 <b>347,00</b>	301,60 <b>377,00</b>	323,20 <b>404,00</b>		374,40 <b>468,00</b>	353,60 <b>442,00</b>	377,60 <b>472,00</b>	371,20 <b>464,00</b>	413,60 <b>517,00</b>	
<b>GZL 1051B</b>	Ručno upravljanje, ovjes, s donjom ručkom, borovo drvo, završno premazano u dva sloja, prozirni lak, dvostruko staklo	1.3	15-90	-	-	-	284,00 <b>355,00</b>	-	277,60 <b>347,00</b>	301,60 <b>377,00</b>	323,20 <b>404,00</b>		374,40 <b>468,00</b>	353,60 <b>442,00</b>	377,60 <b>472,00</b>	-	-	
<b>GLU 0051</b>	Ručno upravljanje, s gornjom ručkom, bijeli poliuretani oblikovan oko drvene jezgre s dodatnim izdržljivim premazom, dvostruko staklo	1.3	15-90	310,40 <b>388,00</b>	-	-	383,20 <b>479,00</b>	420,00 <b>525,00</b>	375,20 <b>469,00</b>	408,00 <b>510,00</b>	436,80 <b>546,00</b>		505,60 <b>632,00</b>	-	-	-	559,20 <b>699,00</b>	
<b>GLU 0051B</b>	Ručno upravljanje, ovjes, s donjom ručkom, bijeli poliuretani oblikovan oko drvene jezgre s dodatnim izdržljivim premazom, dvostruko staklo	1.3	15-90	-	-	-	383,20 <b>479,00</b>	-	375,20 <b>469,00</b>	408,00 <b>510,00</b>	436,80 <b>546,00</b>		-	-	510,40 <b>638,00</b>	-	-	



Cijena bez PDV-a (€)  
Cijena s PDV-om (€)

CKO2 55x78	CKO4 55x98	FKO4 66x98	FKO6 66x118	FKO8 66x140	MKO4 78x98	MKO6 78x118	MKO8 78x140	MK10 78x160	PKO6 94x118	PKO8 94x140	SKO6 114x118	SKO8 114x140

		W/(m <sup>2</sup> K)		Nagib krova														
<b>GLL 1061</b>	Ručno upravljanje, s gornjom ručkom, borovo drvo, završno premazano u dva sloja, prozirni lak, trostruko staklo	1.1	15-90	310,40 <b>388,00</b>	330,40 <b>413,00</b>	367,20 <b>459,00</b>	383,20 <b>479,00</b>	420,00 <b>525,00</b>	375,20 <b>469,00</b>	408,00 <b>510,00</b>	436,80 <b>546,00</b>		505,60 <b>632,00</b>	477,60 <b>597,00</b>	510,40 <b>638,00</b>	501,60 <b>627,00</b>	559,20 <b>699,00</b>	
<b>GLL 1061B</b>	Ručno upravljanje, ovjes, s donjom ručkom, borovo drvo, završno premazano u dva sloja, prozirni lak, trostruko staklo	1.1	15-90	-	330,40 <b>413,00</b>	-	383,20 <b>479,00</b>	420,00 <b>525,00</b>	375,20 <b>469,00</b>	408,00 <b>510,00</b>	436,80 <b>546,00</b>		505,60 <b>632,00</b>	-	510,40 <b>638,00</b>	-	-	
<b>GLU 0061</b>	Ručno upravljanje, s gornjom ručkom, bijeli poliuretani oblikovan oko drvene jezgre s dodatnim izdržljivim premazom, trostruko staklo	1.1	15-90	388,00 <b>485,00</b>	412,80 <b>516,00</b>	-	479,20 <b>599,00</b>	525,60 <b>657,00</b>	469,60 <b>587,00</b>	510,40 <b>638,00</b>	545,60 <b>682,00</b>		632,80 <b>791,00</b>	-	637,60 <b>797,00</b>	-	698,40 <b>873,00</b>	
<b>GLU 0061B</b>	Ručno upravljanje, ovjes, s donjom ručkom, bijeli poliuretani oblikovan oko drvene jezgre s dodatnim izdržljivim premazom, trostruko staklo	1.1	15-90	-	412,80 <b>516,00</b>	-	479,20 <b>599,00</b>	525,60 <b>657,00</b>	469,60 <b>587,00</b>	510,40 <b>638,00</b>	545,60 <b>682,00</b>		632,80 <b>791,00</b>	-	637,60 <b>797,00</b>	-	-	

		W/(m <sup>2</sup> K)		Nagib krova														
<b>GLL 106121</b>	Električni, borovo drvo, završno premazano u dva sloja, prozirni lak, trostruko staklo	1.1	15-90	695,20 <b>869,00</b>	-	-	768,00 <b>960,00</b>	-	760,00 <b>950,00</b>	792,80 <b>991,00</b>	821,60 <b>1.027,00</b>		890,40 <b>1.113,00</b>	-	895,20 <b>1.119,00</b>	-	-	
<b>GLL 106130</b>	Solarni, borovo drvo, završno premazano u dva sloja, prozirni lak, trostruko staklo	1.1	15-90	695,20 <b>869,00</b>	-	-	768,00 <b>960,00</b>	-	760,00 <b>950,00</b>	792,80 <b>991,00</b>	821,60 <b>1.027,00</b>		890,40 <b>1.113,00</b>	-	895,20 <b>1.119,00</b>	-	-	
<b>GLU 006121</b>	Električni, bijeli poliuretani oblikovan oko drvene jezgre s dodatnim izdržljivim premazom, trostruko staklo	1.1	15-90	772,80 <b>966,00</b>	-	-	864,00 <b>1.080,00</b>	-	854,40 <b>1.068,00</b>	895,20 <b>1.119,00</b>	930,40 <b>1.163,00</b>		1.017,60 <b>1.272,00</b>	-	1.022,40 <b>1.278,00</b>	-	-	
<b>GLU 006130</b>	Solarni, bijeli poliuretani oblikovan oko drvene jezgre s dodatnim izdržljivim premazom, trostruko staklo	1.1	15-90	772,80 <b>966,00</b>	-	-	864,00 <b>1.080,00</b>	-	854,40 <b>1.068,00</b>	895,20 <b>1.119,00</b>	930,40 <b>1.163,00</b>		1.017,60 <b>1.272,00</b>	-	1.022,40 <b>1.278,00</b>	-	-	

NOVO  
2024

Dimenzije okvira krovnog prozora, cm	Stara oznaka dimenzije			Nova oznaka dimenzije
	Proizvedeno do 1992	Proizvedeno do 2003	Proizvedeno do 2014	Dostupno danas
55 x 78	-	102	C02	<b>CKO2</b>
55 x 98	6	104	C04	<b>CKO4</b>
66 x 98	-	204	F04	<b>FKO4</b>
66 x 118	-	206	F06	<b>FKO6</b>
66 x 140	-	-	F08	<b>FKO8</b>
70 x 118	5	-	-	<b>FKO6*</b>
78 x 98	1	304	M04	<b>MKO4</b>
78 x 118	14	306	M06	<b>MKO6</b>
78 x 140	12	308	M08	<b>MKO8</b>
78 x 160	13	310	M10	<b>MK10</b>
94 x 98	-	404	P04	<b>PKO4</b>
94 x 118	-	406	P06	<b>PKO6</b>
94 x 140	-	408	P08	<b>PKO8</b>
94 x 160	13	410	P10	<b>PK10</b>
114 x 118	14	606	S06	<b>SKO6</b>
114 x 140	10	608	S08	<b>SKO8</b>
114 x 160	-	610	S10	<b>SK10</b>
134 x 98	-	804	U04	<b>UKO4</b>
134 x 140	8	808	U08	<b>UKO8</b>
134 x 160	-	810	U10	<b>UK10</b>

\* Prozor u dimenziji FKO6 je 4 cm uži od prozora dimenzije s oznakom 5, starije generacije.



Cijena bez PDV-a (€)  
Cijena s PDV-om (€)

CK02 55x78	CK04 55x98	CK06 55x118	FK04 66x98	FK06 66x118	FK08 66x140	MK04 78x98	MK06 78x118			MK08 78x140	MK10 78x160	MK12 78x180	PK06 94x118	PK08 94x140	PK10 94x160	SK06 114x118	SK08 114x140	SK10 114x160	UK04 134x98	UK08 134x140	UK10 134x160		

### PREMIUM, GORNJA RUČKA

		W/(m <sup>2</sup> K)	Nagib krova																						
GGL 3070	Ručno upravljanje, s gornjom ručkom, borovo drvo, završno premazano u tri sloja, prozirni lak, dvostruko staklo	1.3	15-90	318,40 <b>398,00</b>	339,20 <b>424,00</b>	377,60 <b>472,00</b>	377,60 <b>472,00</b>	394,40 <b>493,00</b>	432,00 <b>540,00</b>	385,60 <b>482,00</b>	419,20 <b>524,00</b>			448,80 <b>561,00</b>	520,00 <b>650,00</b>	591,20 <b>739,00</b>	490,40 <b>613,00</b>	524,00 <b>655,00</b>	565,60 <b>707,00</b>	516,00 <b>645,00</b>	574,40 <b>718,00</b>	636,80 <b>796,00</b>	528,00 <b>660,00</b>	641,60 <b>802,00</b>	720,80 <b>901,00</b>
GGL 3070Q	Ručno upravljanje, s gornjom ručkom, borovo drvo, završno premazano u tri sloja, prozirni lak, dvostruko staklo	1.3	15-90	414,40 <b>518,00</b>	441,60 <b>552,00</b>	-	-	512,00 <b>640,00</b>	-	501,60 <b>627,00</b>	544,80 <b>681,00</b>			583,20 <b>729,00</b>	676,00 <b>845,00</b>	-	637,60 <b>797,00</b>	681,60 <b>852,00</b>	736,00 <b>920,00</b>	670,40 <b>838,00</b>	746,40 <b>933,00</b>	828,00 <b>1.035,00</b>	686,40 <b>858,00</b>	833,60 <b>1.042,00</b>	937,60 <b>1.172,00</b>
GGL 3068	Ručno upravljanje, s gornjom ručkom, borovo drvo, završno premazano u tri sloja, prozirni lak, trostruko staklo	1.1	15-90	398,40 <b>498,00</b>	424,80 <b>531,00</b>	472,00 <b>590,00</b>	472,00 <b>590,00</b>	492,80 <b>616,00</b>	540,00 <b>675,00</b>	482,40 <b>603,00</b>	524,00 <b>655,00</b>			560,80 <b>701,00</b>	649,60 <b>812,00</b>	739,20 <b>924,00</b>	612,80 <b>766,00</b>	655,20 <b>819,00</b>	707,20 <b>884,00</b>	644,80 <b>806,00</b>	717,60 <b>897,00</b>	796,80 <b>996,00</b>	660,00 <b>825,00</b>	801,60 <b>1.002,00</b>	901,60 <b>1.127,00</b>
GGL 3066	Ručno upravljanje, s gornjom ručkom, borovo drvo, završno premazano u tri sloja, prozirni lak, trostruko staklo	1.0	15-90	446,40 <b>558,00</b>	475,20 <b>594,00</b>	528,00 <b>660,00</b>	528,00 <b>660,00</b>	552,00 <b>690,00</b>	604,80 <b>756,00</b>	540,00 <b>675,00</b>	587,20 <b>734,00</b>			628,00 <b>785,00</b>	728,00 <b>910,00</b>	827,20 <b>1.034,00</b>	686,40 <b>858,00</b>	733,60 <b>917,00</b>	792,00 <b>990,00</b>	721,60 <b>902,00</b>	804,00 <b>1.005,00</b>	892,00 <b>1.115,00</b>	739,20 <b>924,00</b>	897,60 <b>1.122,00</b>	1.009,60 <b>1.262,00</b>
GGL 3062	Ručno upravljanje, s gornjom ručkom, borovo drvo, završno premazano u tri sloja, prozirni lak, trostruko staklo	0.92	15-90	554,40 <b>693,00</b>	591,20 <b>739,00</b>	656,80 <b>821,00</b>	656,80 <b>821,00</b>	685,60 <b>857,00</b>	751,20 <b>939,00</b>	671,20 <b>839,00</b>	729,60 <b>912,00</b>			780,80 <b>976,00</b>	904,80 <b>1.131,00</b>	-	853,60 <b>1.067,00</b>	912,00 <b>1.140,00</b>	984,80 <b>1.231,00</b>	896,80 <b>1.121,00</b>	999,20 <b>1.249,00</b>	-	-	-	-
GGU 0070	Ručno upravljanje, s gornjom ručkom, bijeli poliuretani oblikovan oko drvene jezgre s dodatnim izdržljivim premazom, dvostruko staklo	1.3	15-90	398,40 <b>498,00</b>	424,80 <b>531,00</b>	472,00 <b>590,00</b>	472,00 <b>590,00</b>	492,80 <b>616,00</b>	540,00 <b>675,00</b>	482,40 <b>603,00</b>	524,00 <b>655,00</b>			560,80 <b>701,00</b>	649,60 <b>812,00</b>		612,80 <b>766,00</b>	655,20 <b>819,00</b>	707,20 <b>884,00</b>	644,80 <b>806,00</b>	717,60 <b>897,00</b>	796,80 <b>996,00</b>	660,00 <b>825,00</b>	801,60 <b>1.002,00</b>	901,60 <b>1.127,00</b>
GGU 0068	Ručno upravljanje, s gornjom ručkom, bijeli poliuretani oblikovan oko drvene jezgre s dodatnim izdržljivim premazom, trostruko staklo	1.1	15-90	497,60 <b>622,00</b>	530,40 <b>663,00</b>	589,60 <b>737,00</b>	589,60 <b>737,00</b>	616,00 <b>770,00</b>	674,40 <b>843,00</b>	602,40 <b>753,00</b>	655,20 <b>819,00</b>			700,80 <b>876,00</b>	812,00 <b>1.015,00</b>		766,40 <b>958,00</b>	818,40 <b>1.023,00</b>	884,00 <b>1.105,00</b>	805,60 <b>1.007,00</b>	897,60 <b>1.122,00</b>	996,00 <b>1.245,00</b>	825,60 <b>1.032,00</b>	1.002,40 <b>1.253,00</b>	1.126,40 <b>1.408,00</b>
GGU 0066	Ručno upravljanje, s gornjom ručkom, bijeli poliuretani oblikovan oko drvene jezgre s dodatnim izdržljivim premazom, trostruko staklo	1.0	15-90	557,60 <b>697,00</b>	594,40 <b>743,00</b>	660,00 <b>825,00</b>	660,00 <b>825,00</b>	689,60 <b>862,00</b>	756,00 <b>945,00</b>	675,20 <b>844,00</b>	733,60 <b>917,00</b>			784,80 <b>981,00</b>	909,60 <b>1.137,00</b>		858,40 <b>1.073,00</b>	916,80 <b>1.146,00</b>	990,40 <b>1.238,00</b>	902,40 <b>1.128,00</b>	1.004,80 <b>1.256,00</b>	1.115,20 <b>1.394,00</b>	924,00 <b>1.155,00</b>	1.122,40 <b>1.403,00</b>	1.261,60 <b>1.577,00</b>
GGU 0062	Ručno upravljanje, s gornjom ručkom, bijeli poliuretani oblikovan oko drvene jezgre s dodatnim izdržljivim premazom, trostruko staklo	0.92	15-90	692,80 <b>866,00</b>	738,40 <b>923,00</b>	820,80 <b>1.026,00</b>	820,80 <b>1.026,00</b>	856,80 <b>1.071,00</b>	939,20 <b>1.174,00</b>	839,20 <b>1.049,00</b>	912,00 <b>1.140,00</b>			975,20 <b>1.219,00</b>	1.130,40 <b>1.413,00</b>		1.066,40 <b>1.333,00</b>	1.140,00 <b>1.425,00</b>	1.231,20 <b>1.539,00</b>	1.121,60 <b>1.402,00</b>	1.248,80 <b>1.561,00</b>	-	-	-	-
GGU 0070Q	Ručno upravljanje, s gornjom ručkom, bijeli poliuretani oblikovan oko drvene jezgre s dodatnim izdržljivim premazom, dvostruko staklo	1.3	15-90	517,60 <b>647,00</b>	552,00 <b>690,00</b>	-	612,80 <b>766,00</b>	640,00 <b>800,00</b>	-	626,40 <b>783,00</b>	681,60 <b>852,00</b>			728,80 <b>911,00</b>	844,80 <b>1.056,00</b>		796,80 <b>996,00</b>	851,20 <b>1.064,00</b>	920,00 <b>1.150,00</b>	837,60 <b>1.047,00</b>	933,60 <b>1.167,00</b>	-	858,40 <b>1.073,00</b>	1.042,40 <b>1.303,00</b>	-
GGL 2070	Ručno upravljanje, s gornjom ručkom, borovo drvo, završno premazano u tri sloja, obojeno bijelom bojom, dvostruko staklo	1.3	15-90	318,40 <b>398,00</b>	339,20 <b>424,00</b>	377,60 <b>472,00</b>	377,60 <b>472,00</b>	394,40 <b>493,00</b>	432,00 <b>540,00</b>	385,60 <b>482,00</b>	419,20 <b>524,00</b>			448,80 <b>561,00</b>	520,00 <b>650,00</b>	591,20 <b>739,00</b>	490,40 <b>613,00</b>	524,00 <b>655,00</b>	565,60 <b>707,00</b>	516,00 <b>645,00</b>	574,40 <b>718,00</b>	636,80 <b>796,00</b>	528,00 <b>660,00</b>	641,60 <b>802,00</b>	720,80 <b>901,00</b>
GGL 2070Q	Ručno upravljanje, s gornjom ručkom, borovo drvo, završno premazano u tri sloja, obojeno bijelom bojom, dvostruko staklo	1.3	15-90	414,40 <b>518,00</b>	441,60 <b>552,00</b>	-	490,40 <b>613,00</b>	512,00 <b>640,00</b>	-	501,60 <b>627,00</b>	544,80 <b>681,00</b>			583,20 <b>729,00</b>	676,00 <b>845,00</b>	-	637,60 <b>797,00</b>	681,60 <b>852,00</b>	736,00 <b>920,00</b>	670,40 <b>838,00</b>	746,40 <b>933,00</b>	828,00 <b>1.035,00</b>	686,40 <b>858,00</b>	833,60 <b>1.042,00</b>	937,60 <b>1.172,00</b>
GGL 2068	Ručno upravljanje, s gornjom ručkom, borovo drvo, završno premazano u tri sloja, obojeno bijelom bojom, trostruko staklo	1.1	15-90	398,40 <b>498,00</b>	424,80 <b>531,00</b>	472,00 <b>590,00</b>	472,00 <b>590,00</b>	492,80 <b>616,00</b>	540,00 <b>675,00</b>	482,40 <b>603,00</b>	524,00 <b>655,00</b>			560,80 <b>701,00</b>	649,60 <b>812,00</b>	739,20 <b>924,00</b>	612,80 <b>766,00</b>	655,20 <b>819,00</b>	707,20 <b>884,00</b>	644,80 <b>806,00</b>	717,60 <b>897,00</b>	796,80 <b>996,00</b>	660,00 <b>825,00</b>	801,60 <b>1.002,00</b>	901,60 <b>1.127,00</b>
GGL 2066	Ručno upravljanje, s gornjom ručkom, borovo drvo, završno premazano u tri sloja, obojeno bijelom bojom, trostruko staklo	1.0	15-90	446,40 <b>558,00</b>	475,20 <b>594,00</b>	528,00 <b>660,00</b>	528,00 <b>660,00</b>	552,00 <b>690,00</b>	604,80 <b>756,00</b>	540,00 <b>675,00</b>	587,20 <b>734,00</b>			628,00 <b>785,00</b>	728,00 <b>910,00</b>	827,20 <b>1.034,00</b>	686,40 <b>858,00</b>	733,60 <b>917,00</b>	792,00 <b>990,00</b>	721,60 <b>902,00</b>	804,00 <b>1.005,00</b>	892,00 <b>1.115,00</b>	739,20 <b>924,00</b>	897,60 <b>1.122,00</b>	1.009,60 <b>1.262,00</b>
GGL 2062	Ručno upravljanje, s gornjom ručkom, borovo drvo, završno premazano u tri sloja, obojeno bijelom bojom, trostruko staklo	0.92	15-90	554,40 <b>693,00</b>	591,20 <b>739,00</b>	656,80 <b>821,00</b>	656,80 <b>821,00</b>	685,60 <b>857,00</b>	751,20 <b>939,00</b>	671,20 <b>839,00</b>	729,60 <b>912,00</b>			780,80 <b>976,00</b>	904,80 <b>1.131,00</b>	-	853,60 <b>1.067,00</b>	912,00 <b>1.140,00</b>	984,80 <b>1.231,00</b>	896,80 <b>1.121,00</b>	999,20 <b>1.249,00</b>	-	-	-	-





Cijena bez PDV-a (€)  
Cijena s PDV-om (€)

CK02 55x78	CK04 55x98	CK06 55x118	FK04 66x98	FK06 66x118	FK08 66x140	MK04 78x98	MK06 78x118			MK08 78x140	MK10 78x160	PK06 94x118	PK08 94x140	PK10 94x160	SK06 114x118	SK08 114x140	SK10 114x160	UK04 134x98	UK08 134x140	UK10 134x160		

### DALJINSKI UPRAVLJANI PROZORI

		W/(m <sup>2</sup> K) Nagib krova																						
<b>GGL 307021</b>	Električni, borovo drvo, završno premazano u tri sloja, prozirni lak, dvostruko staklo	1.3	15-90	704,00 <b>880,00</b>	724,80 <b>906,00</b>	763,20 <b>954,00</b>	763,20 <b>954,00</b>	780,00 <b>975,00</b>	817,60 <b>1.022,00</b>	771,20 <b>964,00</b>	804,80 <b>1.006,00</b>			834,40 <b>1.043,00</b>	905,60 <b>1.132,00</b>	876,00 <b>1.095,00</b>	909,60 <b>1.137,00</b>	951,20 <b>1.189,00</b>	901,60 <b>1.127,00</b>	960,00 <b>1.200,00</b>	1.022,40 <b>1.278,00</b>	913,60 <b>1.142,00</b>	1.027,20 <b>1.284,00</b>	1.106,40 <b>1.383,00</b>
<b>GGL 306821</b>	Električni, borovo drvo, završno premazano u tri sloja, prozirni lak, trostruko staklo	1.1	15-90	784,00 <b>980,00</b>	810,40 <b>1.013,00</b>	857,60 <b>1.072,00</b>	857,60 <b>1.072,00</b>	878,40 <b>1.098,00</b>	925,60 <b>1.157,00</b>	868,00 <b>1.085,00</b>	909,60 <b>1.137,00</b>			946,40 <b>1.183,00</b>	1.035,20 <b>1.294,00</b>	998,40 <b>1.248,00</b>	1.040,80 <b>1.301,00</b>	1.092,80 <b>1.366,00</b>	1.030,40 <b>1.288,00</b>	1.103,20 <b>1.379,00</b>	1.182,40 <b>1.478,00</b>	1.045,60 <b>1.307,00</b>	1.187,20 <b>1.484,00</b>	1.287,20 <b>1.609,00</b>
<b>GGL 306621</b>	Električni, borovo drvo, završno premazano u tri sloja, prozirni lak, trostruko staklo	1.0	15-90	832,00 <b>1.040,00</b>	860,80 <b>1.076,00</b>	913,60 <b>1.142,00</b>	913,60 <b>1.142,00</b>	937,60 <b>1.172,00</b>	990,40 <b>1.238,00</b>	925,60 <b>1.157,00</b>	972,80 <b>1.216,00</b>			1.013,60 <b>1.267,00</b>	1.113,60 <b>1.392,00</b>	1.072,00 <b>1.340,00</b>	1.119,20 <b>1.399,00</b>	1.177,60 <b>1.472,00</b>	1.107,20 <b>1.384,00</b>	1.189,60 <b>1.487,00</b>	1.277,60 <b>1.597,00</b>	1.124,80 <b>1.406,00</b>	1.283,20 <b>1.604,00</b>	1.395,20 <b>1.744,00</b>
<b>GGL 306221</b>	Električni, borovo drvo, završno premazano u tri sloja, prozirni lak, trostruko staklo	0.96	15-90	940,00 <b>1.175,00</b>	976,80 <b>1.221,00</b>	1.042,40 <b>1.303,00</b>	1.042,40 <b>1.303,00</b>	1.071,20 <b>1.339,00</b>	1.136,80 <b>1.421,00</b>	1.056,80 <b>1.321,00</b>	1.115,20 <b>1.394,00</b>			1.166,40 <b>1.458,00</b>	1.290,40 <b>1.613,00</b>	1.239,20 <b>1.549,00</b>	1.297,60 <b>1.622,00</b>	1.370,40 <b>1.713,00</b>	1.282,40 <b>1.603,00</b>	1.384,80 <b>1.731,00</b>	-	-	-	-
<b>GGL 307030</b>	Solarni, borovo drvo, završno premazano u tri sloja, prozirni lak, dvostruko staklo	1.3	15-90	704,00 <b>880,00</b>	724,80 <b>906,00</b>	763,20 <b>954,00</b>	763,20 <b>954,00</b>	780,00 <b>975,00</b>	817,60 <b>1.022,00</b>	771,20 <b>964,00</b>	804,80 <b>1.006,00</b>			834,40 <b>1.043,00</b>	905,60 <b>1.132,00</b>	876,00 <b>1.095,00</b>	909,60 <b>1.137,00</b>	951,20 <b>1.189,00</b>	901,60 <b>1.127,00</b>	960,00 <b>1.200,00</b>	-	913,60 <b>1.142,00</b>	1.027,20 <b>1.284,00</b>	1.106,40 <b>1.383,00</b>
<b>GGL 306830</b>	Solarni, borovo drvo, završno premazano u tri sloja, prozirni lak, trostruko staklo	1.1	15-90	784,00 <b>980,00</b>	810,40 <b>1.013,00</b>	857,60 <b>1.072,00</b>	-	878,40 <b>1.098,00</b>	925,60 <b>1.157,00</b>	868,00 <b>1.085,00</b>	909,60 <b>1.137,00</b>			946,40 <b>1.183,00</b>	-	998,40 <b>1.248,00</b>	-	1.092,80 <b>1.366,00</b>	1.030,40 <b>1.288,00</b>	1.103,20 <b>1.379,00</b>	-	1.045,60 <b>1.307,00</b>	1.187,20 <b>1.484,00</b>	-
<b>GGL 306630</b>	Solarni, borovo drvo, završno premazano u tri sloja, prozirni lak, trostruko staklo	1.0	15-90	832,00 <b>1.040,00</b>	860,80 <b>1.076,00</b>	913,60 <b>1.142,00</b>	-	937,60 <b>1.172,00</b>	990,40 <b>1.238,00</b>	925,60 <b>1.157,00</b>	972,80 <b>1.216,00</b>			1.013,60 <b>1.267,00</b>	1.113,60 <b>1.392,00</b>	-	-	1.177,60 <b>1.472,00</b>	1.107,20 <b>1.384,00</b>	-	-	1.124,80 <b>1.406,00</b>	1.283,20 <b>1.604,00</b>	-
<b>GGU 007021</b>	Električni, bijeli poliuretani oblikovan oko drvene jezgre s dodatnim izdržljivim premazom, dvostruko staklo	1.3	15-90	784,00 <b>980,00</b>	810,40 <b>1.013,00</b>	857,60 <b>1.072,00</b>	857,60 <b>1.072,00</b>	878,40 <b>1.098,00</b>	925,60 <b>1.157,00</b>	868,00 <b>1.085,00</b>	909,60 <b>1.137,00</b>			946,40 <b>1.183,00</b>	1.035,20 <b>1.294,00</b>	998,40 <b>1.248,00</b>	1.040,80 <b>1.301,00</b>	1.092,80 <b>1.366,00</b>	1.030,40 <b>1.288,00</b>	1.103,20 <b>1.379,00</b>	1.182,40 <b>1.478,00</b>	1.045,60 <b>1.307,00</b>	1.187,20 <b>1.484,00</b>	1.287,20 <b>1.609,00</b>
<b>GGU 006821</b>	Električni, bijeli poliuretani oblikovan oko drvene jezgre s dodatnim izdržljivim premazom, trostruko staklo	1.1	15-90	883,20 <b>1.104,00</b>	916,00 <b>1.145,00</b>	975,20 <b>1.219,00</b>	975,20 <b>1.219,00</b>	1.001,60 <b>1.252,00</b>	1.060,00 <b>1.325,00</b>	988,00 <b>1.235,00</b>	1.040,80 <b>1.301,00</b>			1.086,40 <b>1.358,00</b>	1.197,60 <b>1.497,00</b>	1.152,00 <b>1.440,00</b>	1.204,00 <b>1.505,00</b>	1.269,60 <b>1.587,00</b>	1.191,20 <b>1.489,00</b>	1.283,20 <b>1.604,00</b>	1.381,60 <b>1.727,00</b>	1.211,20 <b>1.514,00</b>	1.388,00 <b>1.735,00</b>	1.512,00 <b>1.890,00</b>
<b>GGU 006621</b>	Električni, bijeli poliuretani oblikovan oko drvene jezgre s dodatnim izdržljivim premazom, trostruko staklo	1.0	15-90	943,20 <b>1.179,00</b>	980,00 <b>1.225,00</b>	1.045,60 <b>1.307,00</b>	1.045,60 <b>1.307,00</b>	1.075,20 <b>1.344,00</b>	1.141,60 <b>1.427,00</b>	1.060,80 <b>1.326,00</b>	1.119,20 <b>1.399,00</b>			1.170,40 <b>1.463,00</b>	1.295,20 <b>1.619,00</b>	1.244,00 <b>1.555,00</b>	1.302,40 <b>1.628,00</b>	1.376,00 <b>1.720,00</b>	1.288,00 <b>1.610,00</b>	1.390,40 <b>1.738,00</b>	1.500,80 <b>1.876,00</b>	1.309,60 <b>1.637,00</b>	1.508,00 <b>1.885,00</b>	1.647,20 <b>2.059,00</b>
<b>GGU 006221</b>	Električni, bijeli poliuretani oblikovan oko drvene jezgre s dodatnim izdržljivim premazom, trostruko staklo	0.96	15-90	1.078,40 <b>1.348,00</b>	1.124,00 <b>1.405,00</b>	1.206,40 <b>1.508,00</b>	1.206,40 <b>1.508,00</b>	1.242,40 <b>1.553,00</b>	1.324,80 <b>1.656,00</b>	1.224,80 <b>1.531,00</b>	1.297,60 <b>1.622,00</b>			1.360,80 <b>1.701,00</b>	1.516,00 <b>1.895,00</b>	1.452,00 <b>1.815,00</b>	1.525,60 <b>1.907,00</b>	1.616,80 <b>2.021,00</b>	1.507,20 <b>1.884,00</b>	1.634,40 <b>2.043,00</b>	-	-	-	-
<b>GGU 007030</b>	Solarni, bijeli poliuretani oblikovan oko drvene jezgre s dodatnim izdržljivim premazom, dvostruko staklo	1.3	15-90	784,00 <b>980,00</b>	810,40 <b>1.013,00</b>	857,60 <b>1.072,00</b>	857,60 <b>1.072,00</b>	878,40 <b>1.098,00</b>	925,60 <b>1.157,00</b>	868,00 <b>1.085,00</b>	909,60 <b>1.137,00</b>			946,40 <b>1.183,00</b>	1.035,20 <b>1.294,00</b>	998,40 <b>1.248,00</b>	1.040,80 <b>1.301,00</b>	1.092,80 <b>1.366,00</b>	1.030,40 <b>1.288,00</b>	1.103,20 <b>1.379,00</b>	1.182,40 <b>1.478,00</b>	1.045,60 <b>1.307,00</b>	1.187,20 <b>1.484,00</b>	1.287,20 <b>1.609,00</b>
<b>GGU 006830</b>	Solarni, bijeli poliuretani oblikovan oko drvene jezgre s dodatnim izdržljivim premazom, trostruko staklo	1.1	15-90	883,20 <b>1.104,00</b>	916,00 <b>1.145,00</b>	975,20 <b>1.219,00</b>	-	1.001,60 <b>1.252,00</b>	1.060,00 <b>1.325,00</b>	988,00 <b>1.235,00</b>	1.040,80 <b>1.301,00</b>			1.086,40 <b>1.358,00</b>	-	1.152,00 <b>1.440,00</b>	-	1.269,60 <b>1.587,00</b>	1.191,20 <b>1.489,00</b>	1.283,20 <b>1.604,00</b>	1.381,60 <b>1.727,00</b>	1.211,20 <b>1.514,00</b>	1.388,00 <b>1.735,00</b>	1.512,00 <b>1.890,00</b>
<b>GGU 006630</b>	Solarni, bijeli poliuretani oblikovan oko drvene jezgre s dodatnim izdržljivim premazom, trostruko staklo	1.0	15-90	943,20 <b>1.179,00</b>	980,00 <b>1.225,00</b>	1.045,60 <b>1.307,00</b>	-	1.075,20 <b>1.344,00</b>	1.141,60 <b>1.427,00</b>	1.060,80 <b>1.326,00</b>	1.119,20 <b>1.399,00</b>			1.170,40 <b>1.463,00</b>	1.295,20 <b>1.619,00</b>	1.244,00 <b>1.555,00</b>	1.302,40 <b>1.628,00</b>	1.376,00 <b>1.720,00</b>	1.288,00 <b>1.610,00</b>	-	1.500,80 <b>1.876,00</b>	1.309,60 <b>1.637,00</b>	1.508,00 <b>1.885,00</b>	1.647,20 <b>2.059,00</b>
<b>GPU 006621</b>	Električni, bijeli poliuretani oblikovan oko drvene jezgre s dodatnim izdržljivim premazom, trostruko staklo	1.0	15-65	-	-	-	-	1.404,80 <b>1.756,00</b>	1.471,20 <b>1.839,00</b>	-	1.448,80 <b>1.811,00</b>			1.500,00 <b>1.875,00</b>	-	1.573,60 <b>1.967,00</b>	1.632,00 <b>2.040,00</b>	-	1.617,60 <b>2.022,00</b>	1.720,00 <b>2.150,00</b>	-	-	-	-





Cijena bez PDV-a (€)  
Cijena s PDV-om (€)

--	--	--	--	--	--	--	--	--	--	--	--	--	--	--	--	--	--	--	--

### DALJINSKI UPRAVLJANI PROZORI

		W/(m² K)	Nagib krova																				
<b>GGL 207021</b>	Električni, borovo drvo, završno premazano u tri sloja, obojeno bijelom bojom, dvostruko staklo	1.3	15-90	704,00 <b>880,00</b>	724,80 <b>906,00</b>	763,20 <b>954,00</b>	763,20 <b>954,00</b>	780,00 <b>975,00</b>	817,60 <b>1.022,00</b>	771,20 <b>964,00</b>	804,80 <b>1.006,00</b>	834,40 <b>1.043,00</b>	905,60 <b>1.132,00</b>	-	876,00 <b>1.095,00</b>	909,60 <b>1.137,00</b>	951,20 <b>1.189,00</b>	901,60 <b>1.127,00</b>	960,00 <b>1.200,00</b>	1.022,40 <b>1.278,00</b>	913,60 <b>1.142,00</b>	1.027,20 <b>1.284,00</b>	1.106,40 <b>1.383,00</b>
<b>GGL 206821</b>	Električni, borovo drvo, završno premazano u tri sloja, obojeno bijelom bojom, trostruko staklo	1.1	15-90	784,00 <b>980,00</b>	810,40 <b>1.013,00</b>	857,60 <b>1.072,00</b>	857,60 <b>1.072,00</b>	878,40 <b>1.098,00</b>	925,60 <b>1.157,00</b>	868,00 <b>1.085,00</b>	909,60 <b>1.137,00</b>	946,40 <b>1.183,00</b>	1.035,20 <b>1.294,00</b>	1.124,80 <b>1.406,00</b>	998,40 <b>1.248,00</b>	1.040,80 <b>1.301,00</b>	1.092,80 <b>1.366,00</b>	1.030,40 <b>1.288,00</b>	1.103,20 <b>1.379,00</b>	1.182,40 <b>1.478,00</b>	1.045,60 <b>1.307,00</b>	1.187,20 <b>1.484,00</b>	1.287,20 <b>1.609,00</b>
<b>GGL 206621</b>	Električni, borovo drvo, završno premazano u tri sloja, obojeno bijelom bojom, trostruko staklo	1.0	15-90	832,00 <b>1.040,00</b>	860,80 <b>1.076,00</b>	913,60 <b>1.142,00</b>	913,60 <b>1.142,00</b>	937,60 <b>1.172,00</b>	990,40 <b>1.238,00</b>	925,60 <b>1.157,00</b>	972,80 <b>1.216,00</b>	1.013,60 <b>1.267,00</b>	1.113,60 <b>1.392,00</b>	1.212,80 <b>1.516,00</b>	1.072,00 <b>1.340,00</b>	1.119,20 <b>1.399,00</b>	1.177,60 <b>1.472,00</b>	1.107,20 <b>1.384,00</b>	1.189,60 <b>1.487,00</b>	1.277,60 <b>1.597,00</b>	1.124,80 <b>1.406,00</b>	1.283,20 <b>1.604,00</b>	1.395,20 <b>1.744,00</b>
<b>GGL 206221</b>	Električni, borovo drvo, završno premazano u tri sloja, obojeno bijelom bojom, trostruko staklo	0.96	15-90	940,00 <b>1.175,00</b>	976,80 <b>1.221,00</b>	1.042,40 <b>1.303,00</b>	1.042,40 <b>1.303,00</b>	1.071,20 <b>1.339,00</b>	1.136,80 <b>1.421,00</b>	1.056,80 <b>1.321,00</b>	1.115,20 <b>1.394,00</b>	1.166,40 <b>1.458,00</b>	1.290,40 <b>1.613,00</b>	-	1.239,20 <b>1.549,00</b>	1.297,60 <b>1.622,00</b>	1.370,40 <b>1.713,00</b>	1.282,40 <b>1.603,00</b>	1.384,80 <b>1.731,00</b>	-	-	-	-
<b>GGL 207030</b>	Solarni, borovo drvo, završno premazano u tri sloja, obojeno bijelom bojom, dvostruko staklo	1.3	15-90	704,00 <b>880,00</b>	724,80 <b>906,00</b>	763,20 <b>954,00</b>	763,20 <b>954,00</b>	780,00 <b>975,00</b>	817,60 <b>1.022,00</b>	771,20 <b>964,00</b>	804,80 <b>1.006,00</b>	834,40 <b>1.043,00</b>	905,60 <b>1.132,00</b>	-	876,00 <b>1.095,00</b>	909,60 <b>1.137,00</b>	951,20 <b>1.189,00</b>	901,60 <b>1.127,00</b>	960,00 <b>1.200,00</b>	1.022,40 <b>1.278,00</b>	913,60 <b>1.142,00</b>	1.027,20 <b>1.284,00</b>	1.106,40 <b>1.383,00</b>
<b>GGL 206830</b>	Solarni, borovo drvo, završno premazano u tri sloja, obojeno bijelom bojom, trostruko staklo	1.1	15-90	784,00 <b>980,00</b>	810,40 <b>1.013,00</b>	857,60 <b>1.072,00</b>	-	878,40 <b>1.098,00</b>	925,60 <b>1.157,00</b>	868,00 <b>1.085,00</b>	909,60 <b>1.137,00</b>	946,40 <b>1.183,00</b>	-	-	998,40 <b>1.248,00</b>	-	1.092,80 <b>1.366,00</b>	1.030,40 <b>1.288,00</b>	1.103,20 <b>1.379,00</b>	-	1.045,60 <b>1.307,00</b>	1.187,20 <b>1.484,00</b>	-
<b>GGL 206630</b>	Solarni, borovo drvo, završno premazano u tri sloja, obojeno bijelom bojom, trostruko staklo	1.0	15-90	832,00 <b>1.040,00</b>	860,80 <b>1.076,00</b>	913,60 <b>1.142,00</b>	-	937,60 <b>1.172,00</b>	990,40 <b>1.238,00</b>	925,60 <b>1.157,00</b>	972,80 <b>1.216,00</b>	1.013,60 <b>1.267,00</b>	1.113,60 <b>1.392,00</b>	-	-	1.119,20 <b>1.399,00</b>	1.177,60 <b>1.472,00</b>	1.107,20 <b>1.384,00</b>	-	-	1.124,80 <b>1.406,00</b>	1.283,20 <b>1.604,00</b>	-



Cijena bez PDV-a (€)  
Cijena s PDV-om (€)

--	--	--	--	--	--

### KROVNI PROZORI ZA UGRADNJU NISKE NAGIBE KROVA (10°-20°).

**NAPOMENA!** Uz krovni prozor za ugradnju na niske nagibe GBL 2015 ugrađujemo EDG opšav koji nam osigurava vodonepropusnost.

		W/(m² K)	Nagib krova						
<b>GBL 2015</b>	Ručno upravljanje, s gornjom ručkom, borovo drvo, završno premazano u tri sloja, obojeno bijelom bojom, trostruko staklo	1.1	10-20	424,80 <b>531,00</b>	482,40 <b>603,00</b>	524,00 <b>655,00</b>	560,80 <b>701,00</b>	550,40 <b>688,00</b>	644,80 <b>806,00</b>

Cijena bez PDV-a (€)  
Cijena s PDV-om (€)

Veličine/Dimenzije (cm)

--	--	--	--	--	--







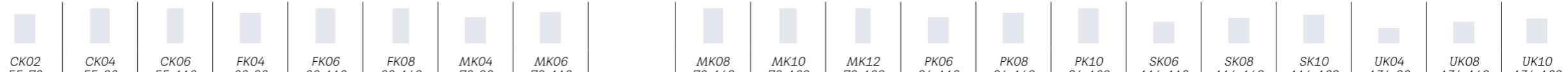

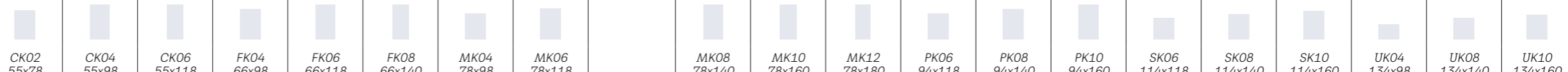







### OPŠAV ZA UGRADNJU ZA NISKE NAGIBE KROVA (10-20) ZA SVE VRSTE PROFILIRANIH KROVNIH POKROVA DO 120 MM.

		Nagib krova						
<b>EDG 1000</b>	Rješenje Basic za krovni prozor GBL, pojedinačna ugradnja	10-20	128,80 <b>161,00</b>	143,20 <b>179,00</b>	151,20 <b>189,00</b>	160,00 <b>200,00</b>	161,60 <b>202,00</b>	178,40 <b>223,00</b>
<b>EDG 2000</b>	Rješenje Energy za krovni prozor GBL, pojedinačna ugradnja	10-20	149,60 <b>187,00</b>	167,20 <b>209,00</b>	176,00 <b>220,00</b>	186,40 <b>233,00</b>	188,00 <b>235,00</b>	207,20 <b>259,00</b>



















# OPŠAVI ZA UGRADNJU KROVNIH PROZORA NA KOSI KROV

Cijena bez PDV-a (€) Cijena s PDV-om (€)																								
Veličine/Dimenzije (cm)		CK02 55x78	CK04 55x98	CK06 55x118	FK04 66x98	FK06 66x118	FK08 66x140	MK04 78x98	MK06 78x118	MK08 78x140	MK10 78x160	MK12 78x180	PK06 94x118	PK08 94x140	PK10 94x160	SK06 114x118	SK08 114x140	SK10 114x160	UK04 134x98	UK08 134x140	UK10 134x160			
<b>POJEDINAČNA UGRADNJA</b>																								
<b>Set za ugradnju Basic 1000 koji sadrži BFX hidroizolacijsku maramicu i odvodni žlijeb</b>																								
Nagib krova																								
<b>Standardna razina ugradnje (crvena razina)</b>																								
EDW 1000	Za profilirane krovne pokrove do 120 mm	15-90	104,80 <b>131,00</b>	107,20 <b>134,00</b>	110,40 <b>138,00</b>	110,40 <b>138,00</b>	120,00 <b>150,00</b>	125,60 <b>157,00</b>	120,00 <b>150,00</b>	125,60 <b>157,00</b>			133,60 <b>167,00</b>	147,20 <b>184,00</b>	149,60 <b>187,00</b>	142,40 <b>178,00</b>	149,60 <b>187,00</b>	155,20 <b>194,00</b>	148,80 <b>186,00</b>	157,60 <b>197,00</b>	164,00 <b>205,00</b>	157,60 <b>197,00</b>	169,60 <b>212,00</b>	188,80 <b>236,00</b>
EDT 1000	Za ravni crijep debljine od 15 do 40 mm	20-90	104,80 <b>131,00</b>	107,20 <b>134,00</b>	110,40 <b>138,00</b>	110,40 <b>138,00</b>	120,00 <b>150,00</b>	125,60 <b>157,00</b>	120,00 <b>150,00</b>	125,60 <b>157,00</b>			133,60 <b>167,00</b>	147,20 <b>184,00</b>	149,60 <b>187,00</b>	142,40 <b>178,00</b>	149,60 <b>187,00</b>	155,20 <b>194,00</b>	148,80 <b>186,00</b>	157,60 <b>197,00</b>	164,00 <b>205,00</b>	157,60 <b>197,00</b>	169,60 <b>212,00</b>	188,80 <b>236,00</b>
EDS 1000	Za ravne krovne pokrove do 16 mm (2 x 8 mm)	15-90	104,80 <b>131,00</b>	107,20 <b>134,00</b>	110,40 <b>138,00</b>	110,40 <b>138,00</b>	120,00 <b>150,00</b>	125,60 <b>157,00</b>	120,00 <b>150,00</b>	125,60 <b>157,00</b>			133,60 <b>167,00</b>	147,20 <b>184,00</b>	149,60 <b>187,00</b>	142,40 <b>178,00</b>	149,60 <b>187,00</b>	155,20 <b>194,00</b>	148,80 <b>186,00</b>	157,60 <b>197,00</b>	164,00 <b>205,00</b>	157,60 <b>197,00</b>	169,60 <b>212,00</b>	188,80 <b>236,00</b>
EDB 1000	Za krov s biber crijepom do 38 mm (2 x 19 mm)	25-90	104,80 <b>131,00</b>	107,20 <b>134,00</b>	110,40 <b>138,00</b>	110,40 <b>138,00</b>	120,00 <b>150,00</b>	125,60 <b>157,00</b>	120,00 <b>150,00</b>	125,60 <b>157,00</b>			133,60 <b>167,00</b>	147,20 <b>184,00</b>	149,60 <b>187,00</b>	142,40 <b>178,00</b>	149,60 <b>187,00</b>	155,20 <b>194,00</b>	148,80 <b>186,00</b>	157,60 <b>197,00</b>	164,00 <b>205,00</b>	157,60 <b>197,00</b>	169,60 <b>212,00</b>	188,80 <b>236,00</b>
<b>Razina upuštene ugradnje 40 mm dublje u krovnu konstrukciju (plava razina)</b>																								
EDJ 1000	Za ravne ili profilirane materijale za krov s profilom do 90 mm	20-90	125,60 <b>157,00</b>	128,80 <b>161,00</b>	132,80 <b>166,00</b>	132,80 <b>166,00</b>	143,20 <b>179,00</b>	151,20 <b>189,00</b>	143,20 <b>179,00</b>	151,20 <b>189,00</b>			160,00 <b>200,00</b>	176,80 <b>221,00</b>	180,00 <b>225,00</b>	170,40 <b>213,00</b>	180,00 <b>225,00</b>	185,60 <b>232,00</b>	178,40 <b>223,00</b>	188,80 <b>236,00</b>	196,80 <b>246,00</b>	188,80 <b>236,00</b>	204,00 <b>255,00</b>	226,40 <b>283,00</b>
EDN 1000	Za ravne krovne pokrove do 16 mm (2 x 8 mm)	20-90	125,60 <b>157,00</b>	128,80 <b>161,00</b>	132,80 <b>166,00</b>	132,80 <b>166,00</b>	143,20 <b>179,00</b>	151,20 <b>189,00</b>	143,20 <b>179,00</b>	151,20 <b>189,00</b>			160,00 <b>200,00</b>	176,80 <b>221,00</b>	180,00 <b>225,00</b>	170,40 <b>213,00</b>	180,00 <b>225,00</b>	185,60 <b>232,00</b>	178,40 <b>223,00</b>	188,80 <b>236,00</b>	196,80 <b>246,00</b>	188,80 <b>236,00</b>	204,00 <b>255,00</b>	226,40 <b>283,00</b>

Cijena bez PDV-a (€) Cijena s PDV-om (€)																								
Veličine/Dimenzije (cm)		CK02 55x78	CK04 55x98	CK06 55x118	FK04 66x98	FK06 66x118	FK08 66x140	MK04 78x98	MK06 78x118	MK08 78x140	MK10 78x160	MK12 78x180	PK06 94x118	PK08 94x140	PK10 94x160	SK06 114x118	SK08 114x140	SK10 114x160	UK04 134x98	UK08 134x140	UK10 134x160			
<b>SET ZA UGRADNJU ENERGY 2000 KOJI SADRŽI BFX HIDROIZOLACIJSKU MARAMICU, ODVODNI ŽLIJEB I TOPLINSKU IZOLACIJU BDX</b>																								
Nagib krova																								
<b>Standardna razina ugradnje (crvena razina)</b>																								
EDW 2000	Za profilirane krovne pokrove do 120 mm	15-90	121,60 <b>152,00</b>	124,80 <b>156,00</b>	128,80 <b>161,00</b>	128,80 <b>161,00</b>	139,20 <b>174,00</b>	146,40 <b>183,00</b>	139,20 <b>174,00</b>	146,40 <b>183,00</b>			155,20 <b>194,00</b>	171,20 <b>214,00</b>	174,40 <b>218,00</b>	165,60 <b>207,00</b>	174,40 <b>218,00</b>	180,00 <b>225,00</b>	172,80 <b>216,00</b>	183,20 <b>229,00</b>	190,40 <b>238,00</b>	183,20 <b>229,00</b>	197,60 <b>247,00</b>	220,00 <b>275,00</b>
EDT 2000	Za ravni crijep debljine od 15 do 40 mm	20-90	121,60 <b>152,00</b>	124,80 <b>156,00</b>	128,80 <b>161,00</b>	128,80 <b>161,00</b>	139,20 <b>174,00</b>	146,40 <b>183,00</b>	139,20 <b>174,00</b>	146,40 <b>183,00</b>			155,20 <b>194,00</b>	171,20 <b>214,00</b>	174,40 <b>218,00</b>	165,60 <b>207,00</b>	174,40 <b>218,00</b>	180,00 <b>225,00</b>	172,80 <b>216,00</b>	183,20 <b>229,00</b>	190,40 <b>238,00</b>	183,20 <b>229,00</b>	197,60 <b>247,00</b>	220,00 <b>275,00</b>
EDS 2000	Za ravne krovne pokrove do 16 mm (2 x 8 mm)	15-90	121,60 <b>152,00</b>	124,80 <b>156,00</b>	128,80 <b>161,00</b>	128,80 <b>161,00</b>	139,20 <b>174,00</b>	146,40 <b>183,00</b>	139,20 <b>174,00</b>	146,40 <b>183,00</b>			155,20 <b>194,00</b>	171,20 <b>214,00</b>	174,40 <b>218,00</b>	165,60 <b>207,00</b>	174,40 <b>218,00</b>	180,00 <b>225,00</b>	172,80 <b>216,00</b>	183,20 <b>229,00</b>	190,40 <b>238,00</b>	183,20 <b>229,00</b>	197,60 <b>247,00</b>	220,00 <b>275,00</b>
EDB 2000	Za krov s biber crijepom do 38 mm (2 x 19 mm)	25-90	121,60 <b>152,00</b>	124,80 <b>156,00</b>	128,80 <b>161,00</b>	128,80 <b>161,00</b>	139,20 <b>174,00</b>	146,40 <b>183,00</b>	139,20 <b>174,00</b>	146,40 <b>183,00</b>			155,20 <b>194,00</b>	171,20 <b>214,00</b>	174,40 <b>218,00</b>	165,60 <b>207,00</b>	174,40 <b>218,00</b>	180,00 <b>225,00</b>	172,80 <b>216,00</b>	183,20 <b>229,00</b>	190,40 <b>238,00</b>	183,20 <b>229,00</b>	197,60 <b>247,00</b>	220,00 <b>275,00</b>
<b>Razina upuštene ugradnje 40 mm dublje u krovnu konstrukciju (plava razina)</b>																								
EDJ 2000	Za ravne ili profilirane materijale za krov s profilom do 90 mm	20-90	145,60 <b>182,00</b>	149,60 <b>187,00</b>	154,40 <b>193,00</b>	154,40 <b>193,00</b>	167,20 <b>209,00</b>	176,00 <b>220,00</b>	167,20 <b>209,00</b>	176,00 <b>220,00</b>			186,40 <b>233,00</b>	205,60 <b>257,00</b>	208,80 <b>261,00</b>	198,40 <b>248,00</b>	208,80 <b>261,00</b>	216,00 <b>270,00</b>	207,20 <b>259,00</b>	220,00 <b>275,00</b>	228,00 <b>285,00</b>	220,00 <b>275,00</b>	236,80 <b>296,00</b>	263,20 <b>329,00</b>
EDN 2000	Za ravne krovne pokrove do 16 mm (2 x 8 mm)	20-90	145,60 <b>182,00</b>	149,60 <b>187,00</b>	154,40 <b>193,00</b>	154,40 <b>193,00</b>	167,20 <b>209,00</b>	176,00 <b>220,00</b>	167,20 <b>209,00</b>	176,00 <b>220,00</b>			186,40 <b>233,00</b>	205,60 <b>257,00</b>	208,80 <b>261,00</b>	198,40 <b>248,00</b>	208,80 <b>261,00</b>	216,00 <b>270,00</b>	207,20 <b>259,00</b>	220,00 <b>275,00</b>	228,00 <b>285,00</b>	220,00 <b>275,00</b>	236,80 <b>296,00</b>	263,20 <b>329,00</b>

Cijena bez PDV-a (€) Cijena s PDV-om (€)																					
Veličine/Dimenzije (cm)			CK02 55x78	CK04 55x98	FK04 66x98	FK06 66x118	MK04 78x98	MK06 78x118	MK08 78x140	MK10 78x160		PK06 94x118	PK08 94x140	PK10 94x160	SK06 114x118	SK08 114x140	SK10 114x160	UK04 134x98	UK08 134x140	UK10 134x160	
<b>OPŠAVI ZA ZAMJENU PROZORA</b>																					
Varijanta 0000 zahtjeva BFX Varijanta 1000 uključuje BFX																					
		Nagib krova																			
<b>EW 0000</b>	Za profilirane krovne pokrove do 120 mm	15-90	68,00 <b>85,00</b>	69,60 <b>87,00</b>	72,00 <b>90,00</b>	77,60 <b>97,00</b>	77,60 <b>97,00</b>	81,60 <b>102,00</b>	87,20 <b>109,00</b>	96,00 <b>120,00</b>		92,80 <b>116,00</b>	97,60 <b>122,00</b>	100,80 <b>126,00</b>	96,80 <b>121,00</b>	102,40 <b>128,00</b>	106,40 <b>133,00</b>	102,40 <b>128,00</b>	110,40 <b>138,00</b>	123,20 <b>154,00</b>	
<b>EL 0000</b>	Za ravne krovne pokrove do 16 mm	15-90	68,00 <b>85,00</b>	69,60 <b>87,00</b>	72,00 <b>90,00</b>	77,60 <b>97,00</b>	77,60 <b>97,00</b>	81,60 <b>102,00</b>	87,20 <b>109,00</b>	96,00 <b>120,00</b>		92,80 <b>116,00</b>	97,60 <b>122,00</b>	100,80 <b>126,00</b>	96,80 <b>121,00</b>	102,40 <b>128,00</b>	106,40 <b>133,00</b>	102,40 <b>128,00</b>	110,40 <b>138,00</b>	123,20 <b>154,00</b>	
<b>ELX 0000</b>	Za sve krovne materijale	15-80	68,00 <b>85,00</b>	69,60 <b>87,00</b>	72,00 <b>90,00</b>	77,60 <b>97,00</b>	77,60 <b>97,00</b>	81,60 <b>102,00</b>	87,20 <b>109,00</b>	96,00 <b>120,00</b>		92,80 <b>116,00</b>	97,60 <b>122,00</b>	100,80 <b>126,00</b>	96,80 <b>121,00</b>	102,40 <b>128,00</b>	106,40 <b>133,00</b>	102,40 <b>128,00</b>	110,40 <b>138,00</b>	123,20 <b>154,00</b>	

Opšavi za zamjenu prozora prošle generacije proizvedeni prije 2002. godine.

Cijena bez PDV-a (€) Cijena s PDV-om (€)																					
Veličine/Dimenzije (cm)			CK02 55x78	CK04 55x98	CK06 55x118	FK04 66x98	FK06 66x118	MK04 78x98	MK06 78x118	MK08 78x140		MK10 78x160	PK06 94x118	PK08 94x140	PK10 94x160	SK06 114x118	SK08 114x140	SK10 114x160	UK04 134x98	UK08 134x140	UK10 134x160
<b>IZOLACIJSKE VARIJANTE SADRŽE DODATNU IZOLACIJU I BFX</b>																					
		Nagib krova																			
<b>EW 6000</b>	Za profilirane krovne pokrove do 120 mm	15-90	132,80 <b>166,00</b>	136,00 <b>170,00</b>	140,80 <b>176,00</b>	140,80 <b>176,00</b>	152,80 <b>191,00</b>	152,80 <b>191,00</b>	160,80 <b>201,00</b>	170,40 <b>213,00</b>		188,00 <b>235,00</b>	181,60 <b>227,00</b>	191,20 <b>239,00</b>	197,60 <b>247,00</b>	189,60 <b>237,00</b>	200,80 <b>251,00</b>	208,80 <b>261,00</b>	200,80 <b>251,00</b>	216,80 <b>271,00</b>	240,80 <b>301,00</b>
<b>EL 6000</b>	Za ravne krovne pokrove do 16 mm	15-90	132,80 <b>166,00</b>	136,00 <b>170,00</b>	140,80 <b>176,00</b>	140,80 <b>176,00</b>	152,80 <b>191,00</b>	152,80 <b>191,00</b>	160,80 <b>201,00</b>	170,40 <b>213,00</b>		188,00 <b>235,00</b>	181,60 <b>227,00</b>	191,20 <b>239,00</b>	197,60 <b>247,00</b>	189,60 <b>237,00</b>	200,80 <b>251,00</b>	208,80 <b>261,00</b>	200,80 <b>251,00</b>	216,80 <b>271,00</b>	240,80 <b>301,00</b>

Opšavi za zamjenu prozora prošle generacije proizvedeni prije 2002. godine.





Cijena bez PDV-a (€) Cijena s PDV-om (€)		Veličine/Dimenzije (cm)																				
		CK02	CK04	CK06	FK04	FK06	FK08	MK04	MK06		MK08	MK10	MK12	PK06	PK08	PK10	SK06	SK08	SK10	UK04	UK08	
<b>SIDE-BY-SIDE KOMPLET ZA UGRADNJU SADRŽI: OPŠAV S BDX TOPLINSKOM IZOLACIJOM, BFX HIDROIZOLACIJSKU MARAMICU I ODVODNI ŽLIJEB, GREDE I POKROVNI PROFIL</b>																						
<b>100 MM RAZMAK IZMEĐU OKVIRA</b>																						
Nagib krova																						
<b>Standardna razina ugradnje (crvena razina)</b>																						
<b>EKW 4021E2</b>	Za profilirane krovne pokrove do 120 mm	15-90	411,20 <b>514,00</b>	445,60 <b>557,00</b>	472,00 <b>590,00</b>	459,20 <b>574,00</b>	498,40 <b>623,00</b>	544,80 <b>681,00</b>	487,20 <b>609,00</b>	520,00 <b>650,00</b>		569,60 <b>712,00</b>	630,40 <b>788,00</b>	-	570,40 <b>713,00</b>	620,00 <b>775,00</b>	660,00 <b>825,00</b>	610,40 <b>763,00</b>	663,20 <b>829,00</b>	706,40 <b>883,00</b>	627,20 <b>784,00</b>	706,40 <b>883,00</b>
<b>EKW 4021E3</b>	Za profilirane krovne pokrove do 120 mm	15-90	411,20 <b>514,00</b>	445,60 <b>557,00</b>	472,00 <b>590,00</b>	459,20 <b>574,00</b>	498,40 <b>623,00</b>	544,80 <b>681,00</b>	487,20 <b>609,00</b>	520,00 <b>650,00</b>		569,60 <b>712,00</b>	630,40 <b>788,00</b>	-	570,40 <b>713,00</b>	620,00 <b>775,00</b>	660,00 <b>825,00</b>	610,40 <b>763,00</b>	663,20 <b>829,00</b>	706,40 <b>883,00</b>	627,20 <b>784,00</b>	706,40 <b>883,00</b>
<b>EKS 4021E2</b>	Za ravne krovne pokrove do 16 mm (2 x 8 mm)	15-90	411,20 <b>514,00</b>	445,60 <b>557,00</b>	472,00 <b>590,00</b>	459,20 <b>574,00</b>	498,40 <b>623,00</b>	544,80 <b>681,00</b>	487,20 <b>609,00</b>	520,00 <b>650,00</b>		569,60 <b>712,00</b>	630,40 <b>788,00</b>	-	570,40 <b>713,00</b>	620,00 <b>775,00</b>	660,00 <b>825,00</b>	610,40 <b>763,00</b>	663,20 <b>829,00</b>	706,40 <b>883,00</b>	627,20 <b>784,00</b>	706,40 <b>883,00</b>
<b>EKS 4021E3</b>	Za ravne krovne pokrove do 16 mm (2 x 8 mm)	15-90	411,20 <b>514,00</b>	445,60 <b>557,00</b>	472,00 <b>590,00</b>	459,20 <b>574,00</b>	498,40 <b>623,00</b>	544,80 <b>681,00</b>	487,20 <b>609,00</b>	520,00 <b>650,00</b>		569,60 <b>712,00</b>	630,40 <b>788,00</b>	-	570,40 <b>713,00</b>	620,00 <b>775,00</b>	660,00 <b>825,00</b>	610,40 <b>763,00</b>	663,20 <b>829,00</b>	706,40 <b>883,00</b>	627,20 <b>784,00</b>	706,40 <b>883,00</b>
<b>EKB 4021E</b>	Za krov s biber crijepom do 38 mm (2 x 19 mm)	25-90	427,20 <b>534,00</b>	436,00 <b>545,00</b>	449,60 <b>562,00</b>	455,20 <b>569,00</b>	484,80 <b>606,00</b>	505,60 <b>632,00</b>	492,00 <b>615,00</b>	512,80 <b>641,00</b>		538,40 <b>673,00</b>	584,80 <b>731,00</b>	-	580,00 <b>725,00</b>	604,80 <b>756,00</b>	623,20 <b>779,00</b>	626,40 <b>783,00</b>	656,00 <b>820,00</b>	678,40 <b>848,00</b>	670,40 <b>838,00</b>	713,60 <b>892,00</b>
<b>Razina upuštene ugradnje 40 mm dublje u krovnu konstrukciju (plava razina)</b>																						
<b>EKJ 4021E</b>	Za ravne ili profilirane materijale za krov s profilom do 90 mm	20-90	462,40 <b>578,00</b>	471,20 <b>589,00</b>	484,80 <b>606,00</b>	490,40 <b>613,00</b>	523,20 <b>654,00</b>	547,20 <b>684,00</b>	530,40 <b>663,00</b>	554,40 <b>693,00</b>		581,60 <b>727,00</b>	632,80 <b>791,00</b>	642,40 <b>803,00</b>	626,40 <b>783,00</b>	654,40 <b>818,00</b>	672,80 <b>841,00</b>	674,40 <b>843,00</b>	707,20 <b>884,00</b>	731,20 <b>914,00</b>	721,60 <b>902,00</b>	769,60 <b>962,00</b>
<b>18 MM RAZMAK IZMEĐU OKVIRA</b>																						
<b>Standardna razina ugradnje (crvena razina)</b>																						
<b>EBW 4021B</b>	Za profilirane krovne pokrove do 120 mm	15-90	458,40 <b>573,00</b>	467,20 <b>584,00</b>	480,80 <b>601,00</b>	486,40 <b>608,00</b>	518,40 <b>648,00</b>	541,60 <b>677,00</b>	525,60 <b>657,00</b>	548,80 <b>686,00</b>		576,80 <b>721,00</b>	628,00 <b>785,00</b>	-	621,60 <b>777,00</b>	648,80 <b>811,00</b>	667,20 <b>834,00</b>	669,60 <b>837,00</b>	701,60 <b>877,00</b>	724,80 <b>906,00</b>	716,00 <b>895,00</b>	762,40 <b>953,00</b>
<b>EBS 4021B</b>	Za ravne krovne pokrove do 16 mm (2 x 8 mm)	15-90	445,60 <b>557,00</b>	454,40 <b>568,00</b>	467,20 <b>584,00</b>	472,80 <b>591,00</b>	504,00 <b>630,00</b>	526,40 <b>658,00</b>	511,20 <b>639,00</b>	533,60 <b>667,00</b>		560,80 <b>701,00</b>	609,60 <b>762,00</b>	-	604,00 <b>755,00</b>	630,40 <b>788,00</b>	648,00 <b>810,00</b>	651,20 <b>814,00</b>	682,40 <b>853,00</b>	704,80 <b>881,00</b>	696,80 <b>871,00</b>	741,60 <b>927,00</b>

Opšavi su kompatibilni sa svim modelima VELUX krovnih prozora. Krovni prozori nisu uključeni, moraju se posebno naručiti.  
Za više informacija obratite se VELUX korisničkoj službi.

Cijena bez PDV-a (€) Cijena s PDV-om (€)		Veličine/Dimenzije (cm)												
		CK02	CK04	CK06	FK04	FK06	FK08	MK04	MK06		MK08	MK10	MK12	
<b>TRIO SIDE-BY-SIDE RJEŠENJE ZA UGRADNJU SADRŽI: OPŠAV S BDX TOPLINSKOM IZOLACIJOM, BFX HIDROIZOLACIJSKU MARAMICU I ODVODNI ŽLIJEB, GREDE I POKROVNI PROFIL</b>														
<b>100 mm razmak između okvira</b>														
Nagib krova														
<b>Standardna razina ugradnje (crvena razina)</b>														
<b>EKW 4031E2</b>	Za profilirane krovne pokrove do 120 mm	15-90	650,40 <b>813,00</b>	716,00 <b>895,00</b>	764,80 <b>956,00</b>	753,60 <b>942,00</b>	821,60 <b>1.027,00</b>	907,20 <b>1.134,00</b>	799,20 <b>999,00</b>	857,60 <b>1.072,00</b>		948,00 <b>1.185,00</b>	1.053,60 <b>1.317,00</b>	1.114,40 <b>1.393,00</b>
<b>EKW 4031E3</b>	Za profilirane krovne pokrove do 120 mm	15-90	650,40 <b>813,00</b>	716,00 <b>895,00</b>	764,80 <b>956,00</b>	753,60 <b>942,00</b>	821,60 <b>1.027,00</b>	907,20 <b>1.134,00</b>	799,20 <b>999,00</b>	857,60 <b>1.072,00</b>		948,00 <b>1.185,00</b>	1.053,60 <b>1.317,00</b>	1.114,40 <b>1.393,00</b>
<b>EKS 4031E2</b>	Za ravne krovne pokrove do 16 mm (2 x 8 mm)	15-90	650,40 <b>813,00</b>	716,00 <b>895,00</b>	764,80 <b>956,00</b>	753,60 <b>942,00</b>	821,60 <b>1.027,00</b>	907,20 <b>1.134,00</b>	799,20 <b>999,00</b>	857,60 <b>1.072,00</b>		948,00 <b>1.185,00</b>	1.053,60 <b>1.317,00</b>	-
<b>EKS 4031E3</b>	Za ravne krovne pokrove do 16 mm (2 x 8 mm)	15-90	650,40 <b>813,00</b>	716,00 <b>895,00</b>	764,80 <b>956,00</b>	753,60 <b>942,00</b>	821,60 <b>1.027,00</b>	907,20 <b>1.134,00</b>	799,20 <b>999,00</b>	857,60 <b>1.072,00</b>		948,00 <b>1.185,00</b>	1.053,60 <b>1.317,00</b>	-

Opšavi su kompatibilni sa svim modelima VELUX krovnih prozora. Krovni prozori nisu uključeni, moraju se posebno naručiti.  
Za više informacija obratite se VELUX korisničkoj službi.

Cijena bez PDV-a (€) Cijena s PDV-om (€)		FK06	FK08	MK04	MK06	MK08	MK10	PK06	PK08		PK10	SK06	SK08	SK10	UK04	UK08	UK10	
Veličine/Dimenzije (cm)		Nagib krova																
<b>MINI KROVNA KUĆICA</b>																		
<b>EAW 6000</b>	Mini krovna kućica, opšav EAW za profilirane krovne pokrove ukupne visine do 120 mm, pojedinačna ugradnja, 1 krovni prozor	10-75	663,20 <b>829,00</b>	698,40 <b>873,00</b>	663,20 <b>829,00</b>	698,40 <b>873,00</b>	740,00 <b>925,00</b>	816,80 <b>1.021,00</b>	788,80 <b>986,00</b>	831,20 <b>1.039,00</b>		859,20 <b>1.074,00</b>	824,00 <b>1.030,00</b>	872,80 <b>1.091,00</b>	908,00 <b>1.135,00</b>	872,80 <b>1.091,00</b>	943,20 <b>1.179,00</b>	1.048,00 <b>1.310,00</b>
<b>EAW 6021E</b>	Mini krovna kućica, opšav EAW za profilirane krovne pokrove, kombinirana ugradnja, 2 krovna prozora	10-75	1.990,40 <b>2.488,00</b>	2.095,20 <b>2.619,00</b>	1.990,40 <b>2.488,00</b>	2.095,20 <b>2.619,00</b>	2.220,80 <b>2.776,00</b>	2.451,20 <b>3.064,00</b>	2.367,20 <b>2.959,00</b>	2.493,60 <b>3.117,00</b>		2.576,80 <b>3.221,00</b>	2.472,00 <b>3.090,00</b>	2.619,20 <b>3.274,00</b>	2.724,00 <b>3.405,00</b>	2.619,20 <b>3.274,00</b>	2.828,80 <b>3.536,00</b>	-
<b>EAW 6031E</b>	Mini krovna kućica, opšav EAW za profilirane krovne pokrove ukupne visine do 120 mm, kombinirana ugradnja, 3 krovna prozora	10-75	2.653,60 <b>3.317,00</b>	2.793,60 <b>3.492,00</b>	2.653,60 <b>3.317,00</b>	2.793,60 <b>3.492,00</b>	2.961,60 <b>3.702,00</b>	3.268,80 <b>4.086,00</b>	-	-		-	-	-	-	-	-	-

Cijena bez PDV-a (€) Cijena s PDV-om (€)			MK06 78x118	PK06 94x118	SK06 114x118
Veličine/Dimenzije (cm)		Nagib krova			
<b>KROVNA KUĆICA</b>					
<b>EBW 2022BK</b>	Krovna kućica, opšav EBW za profilirane krovne pokrove ukupne visine do 120 mm, kombinirana ugradnja, 4 krovna prozora	35-70	2.524,00 <b>3.155,00</b>	2.915,20 <b>3.644,00</b>	2.913,60 <b>3.642,00</b>
<b>EBW 2032BK</b>	Krovna kućica, opšav EBW za profilirane krovne pokrove ukupne visine do 120 mm, kombinirana ugradnja, 6 krovna prozora	35-70	3.078,40 <b>3.848,00</b>	-	-

Naši opšavi na mini krovnoj kućici i krovnoj kućici omogućuju ugradnju VELUX krovnih prozora iznad razine krova, stvarajući dodatni prostor za život. Opšavi za krovne kućice dolaze u točnoj dimenziji i obliku kako bi stvorili savršeni, vodonepropusni spoj VELUX krovnih prozora po vašem izboru.

## KROVNA KUĆICA

Minimalna visina stropa (B) – ovisno o nagibu krova (A)

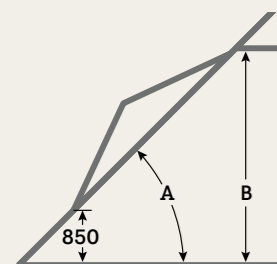

A	min. B mm
35°	2 003
40°	2 171
45°	2 328
50°	2 470
55°	2 600
60°	2 714
65°	2 815
70°	2 900

## Dostupne dimenzije i oznake

Oznaka dimenzije	Kombinacija prozora	Opšavi
<b>MK06</b>	2x2 krovna prozora ili 2x3 krovna prozora	EBW MK06 2022BK EBW MK06 2032BK
<b>PK06</b>	2x2 krovna prozora	EBW PK06 2022BK
<b>SK06</b>	2x2 krovna prozora	EBW SK06 2022BK



Cijena bez PDV-a (€)  
Cijena s PDV-om (€)

MK31 78x60	MK35 78x95	MK36 78x115	MK38 78x137	PK31 94x60	PK35 94x95	PK36 94x115	PK38 94x137	SK31 114x60	SK35 114x95	SK36 114x115	SK38 114x137	UK31 134x60	UK35 134x95	UK36 134x115	UK38 134x137

### VERTIKALNI ELEMENTI, OTKLOPNI /OTKLOPNO-ZAOKRETNI

		W/(m <sup>2</sup> K) Nagib krova																		
VFE 3070	Ručno upravljanje, borovo drvo, završno premazano u tri sloja, prozirni lak, dvostruko staklo	1.3	15-55	447,20 559,00	501,60 627,00	534,40 668,00	556,00 695,00	512,00 640,00	566,40 708,00	588,80 736,00	610,40 763,00		572,00 715,00	621,60 777,00	632,00 790,00	653,60 817,00	621,60 777,00	676,00 845,00	686,40 858,00	730,40 913,00
VFE 3068	Ručno upravljanje, borovo drvo, završno premazano u tri sloja, prozirni lak, trostruko staklo	1.1	15-55	558,40 698,00	626,40 783,00	667,20 834,00	695,20 869,00	640,00 800,00	708,80 886,00	736,00 920,00	763,20 954,00		715,20 894,00	776,80 971,00	790,40 988,00	-	776,80 971,00	844,80 1.056,00	-	-
VFE 3066	Ručno upravljanje, borovo drvo, završno premazano u tri sloja, prozirni lak, trostruko staklo	1.0	15-55	625,60 782,00	701,60 877,00	-	-	716,80 896,00	793,60 992,00	-	-		800,80 1.001,00	869,60 1.087,00	-	-	869,60 1.087,00	946,40 1.183,00	-	-
VFE 3062	Ručno upravljanje, borovo drvo, završno premazano u tri sloja, prozirni lak, trostruko staklo	1.0	15-55	777,60 972,00	872,00 1.090,00	-	-	891,20 1.114,00	986,40 1.233,00	-	-		996,00 1.245,00	1.080,80 1.351,00	-	-	1.080,80 1.351,00	1.176,00 1.470,00	-	-
VFA 3070	Ručno upravljanje, borovo drvo, završno premazano u tri sloja, prozirni lak, dvostruko staklo	1.3	15-55	-	578,40 723,00	616,00 770,00	641,60 802,00	-	653,60 817,00	679,20 849,00	704,00 880,00		-	716,80 896,00	729,60 912,00	754,40 943,00	-	-	-	-
VFA 3068	Ručno upravljanje, borovo drvo, završno premazano u tri sloja, prozirni lak, trostruko staklo	1.1	15-55	-	723,20 904,00	770,40 963,00	801,60 1.002,00	-	817,60 1.022,00	848,80 1.061,00	880,00 1.100,00		-	896,00 1.120,00	912,00 1.140,00	943,20 1.179,00	-	-	-	-
VFA 3066	Ručno upravljanje, borovo drvo, završno premazano u tri sloja, prozirni lak, trostruko staklo	1.0	15-55	-	809,60 1.012,00	862,40 1.078,00	897,60 1.122,00	-	915,20 1.144,00	950,40 1.188,00	985,60 1.232,00		-	1.003,20 1.254,00	1.020,80 1.276,00	1.056,00 1.320,00	-	-	-	-
VFB 3070	Ručno upravljanje, borovo drvo, završno premazano u tri sloja, prozirni lak, dvostruko staklo	1.3	15-55	-	578,40 723,00	616,00 770,00	641,60 802,00	-	653,60 817,00	679,20 849,00	704,00 880,00		-	716,80 896,00	729,60 912,00	754,40 943,00	-	-	-	-
VFB 3068	Ručno upravljanje, borovo drvo, završno premazano u tri sloja, prozirni lak, trostruko staklo	1.1	15-55	-	723,20 904,00	770,40 963,00	801,60 1.002,00	-	817,60 1.022,00	848,80 1.061,00	880,00 1.100,00		-	896,00 1.120,00	912,00 1.140,00	943,20 1.179,00	-	-	-	-
VFB 3066	Ručno upravljanje, borovo drvo, završno premazano u tri sloja, prozirni lak, trostruko staklo	1.0	15-55	-	809,60 1.012,00	862,40 1.078,00	897,60 1.122,00	-	915,20 1.144,00	950,40 1.188,00	985,60 1.232,00		-	1.003,20 1.254,00	1.020,80 1.276,00	1.056,00 1.320,00	-	-	-	-

Vertikalni element VFE dizajniran je za kombinaciju s krovnim prozorima GGL/GPL/GLL ili GIL prozorom. VFE prozor se ne može ugraditi zasebno.



Cijena bez PDV-a (€)  
Cijena s PDV-om (€)

MK31 78x60	MK35 78x95	MK36 78x115	MK38 78x137	PK31 94x60	PK35 94x95	PK36 94x115	PK38 94x137	SK31 114x60	SK35 114x95	SK36 114x115	SK38 114x137

### VERTIKALNI ELEMENTI, FIKSNI

		W/(m <sup>2</sup> K) Nagib krova																		
VIU 0070	Fiksno, bijeli poliuretani oblikovan oko drvene jezgre s dodatnim izdržljivim premazom, dvostruko staklo	1.3	15-55	388,80 486,00	436,00 545,00	464,00 580,00	483,20 604,00	445,60 557,00	492,80 616,00	511,20 639,00	530,40 663,00		497,60 622,00	540,00 675,00	549,60 687,00	568,80 711,00				
VIU 0068	Fiksno, bijeli poliuretani oblikovan oko drvene jezgre s dodatnim izdržljivim premazom, trostruko staklo	1.1	15-55	485,60 607,00	544,80 681,00	-	-	556,80 696,00	616,00 770,00	-	-		621,60 777,00	675,20 844,00	-	-				
VIU 0066	Fiksno, bijeli poliuretani oblikovan oko drvene jezgre s dodatnim izdržljivim premazom, trostruko staklo	1.0	15-55	544,00 680,00	610,40 763,00	-	-	623,20 779,00	689,60 862,00	-	-		696,00 870,00	756,00 945,00	-	-				
VIU 0062	Fiksno, bijeli poliuretani oblikovan oko drvene jezgre s dodatnim izdržljivim premazom, trostruko staklo	1.0	15-55	676,00 845,00	758,40 948,00	-	-	774,40 968,00	857,60 1.072,00	-	-		865,60 1.082,00	940,00 1.175,00	-	-				

Vertikalni element VIU dizajniran je za kombinaciju s krovnim prozorima GGL/GPL/GLL ili GIL prozorom. VIU prozor se ne može ugraditi zasebno.





Cijena bez PDV-a (€)  
Cijena s PDV-om (€)

Veličine/Dimenzije (cm)

MKO4  
78x98

MKO6  
78x118

MKO8  
78x140

MK10  
78x160

MK12  
78x180

PK06  
94x118

PK08  
94x140

PK10  
94x160

SK06  
114x118

SK08  
114x140

SK10  
114x160

UK04  
134x98

UK08  
134x140

UK10  
134x160

**KOMBINACIJA KROVNOG PROZORA I VERTIKALNOG ELEMENTA VFA, VFB, VFE ILI VIU  
ZA POJEDINAČNU UGRADNJU KROVNOG PROZORA S VERTIKALNIM ELEMENTOM**

Nagib  
krova

**Standardna razina ugradnje (crvena razina)**

<b>EFW 0012</b>	Za profilirane krovne pokrove do 120 mm	15-55	190,40 <b>238,00</b>	200,00 <b>250,00</b>	212,00 <b>265,00</b>	234,40 <b>293,00</b>	238,40 <b>298,00</b>	226,40 <b>283,00</b>	238,40 <b>298,00</b>	246,40 <b>308,00</b>		236,00 <b>295,00</b>	250,40 <b>313,00</b>	260,00 <b>325,00</b>	250,40 <b>313,00</b>	270,40 <b>338,00</b>	300,00 <b>375,00</b>
<b>EFS 0012</b>	Za ravne krovne pokrove do 16 mm (2 x 8 mm)	15-55	226,40 <b>283,00</b>	238,40 <b>298,00</b>	252,00 <b>315,00</b>	278,40 <b>348,00</b>	-	268,80 <b>336,00</b>	283,20 <b>354,00</b>	292,80 <b>366,00</b>		280,80 <b>351,00</b>	297,60 <b>372,00</b>	309,60 <b>387,00</b>	-	321,60 <b>402,00</b>	356,80 <b>446,00</b>

**Razina upuštene ugradnje 40 mm dublje u krovnu konstrukciju (plava razina)**

<b>EFJ 0012</b>	Za ravne ili profilirane materijale za krov s profilom do 90 mm	20-55	228,00 <b>285,00</b>	240,00 <b>300,00</b>	254,40 <b>318,00</b>	280,80 <b>351,00</b>	285,60 <b>357,00</b>	271,20 <b>339,00</b>	285,60 <b>357,00</b>	295,20 <b>369,00</b>		283,20 <b>354,00</b>	300,00 <b>375,00</b>	312,00 <b>390,00</b>	300,00 <b>375,00</b>	324,00 <b>405,00</b>	360,00 <b>450,00</b>
<b>EFN 0012</b>	Za ravne krovne pokrove do 16 mm (2 x 8 mm)	20-55	228,00 <b>285,00</b>	240,00 <b>300,00</b>	254,40 <b>318,00</b>	-	285,60 <b>357,00</b>	271,20 <b>339,00</b>	285,60 <b>357,00</b>	295,20 <b>369,00</b>		283,20 <b>354,00</b>	300,00 <b>375,00</b>	-	300,00 <b>375,00</b>	324,00 <b>405,00</b>	-

**ZA UGRADNJU DUO KOMBINACIJE S VERTIKALNIM ELEMENTIMA**

**Standardna razina ugradnje (crvena razina)**

<b>EFW 0022E</b>	Za profilirane krovne pokrove do 120 mm	15-55	323,20 <b>404,00</b>	340,00 <b>425,00</b>	360,80 <b>451,00</b>	397,60 <b>497,00</b>	404,80 <b>506,00</b>	384,00 <b>480,00</b>	404,80 <b>506,00</b>	418,40 <b>523,00</b>		401,60 <b>502,00</b>	424,80 <b>531,00</b>	442,40 <b>553,00</b>	424,80 <b>531,00</b>	459,20 <b>574,00</b>	510,40 <b>638,00</b>
<b>EFS 0022E</b>	Za ravne krovne pokrove do 16 mm (2 x 8 mm)	15-55	384,00 <b>480,00</b>	404,80 <b>506,00</b>	428,80 <b>536,00</b>	473,60 <b>592,00</b>	481,60 <b>602,00</b>	456,80 <b>571,00</b>	481,60 <b>602,00</b>	497,60 <b>622,00</b>		477,60 <b>597,00</b>	505,60 <b>632,00</b>	525,60 <b>657,00</b>	505,60 <b>632,00</b>	546,40 <b>683,00</b>	607,20 <b>759,00</b>

**Razina upuštene ugradnje 40 mm dublje u krovnu konstrukciju (plava razina)**

<b>EFJ 0022E</b>	Za ravne ili profilirane materijale za krov s profilom do 90 mm	20-55	388,00 <b>485,00</b>	408,00 <b>510,00</b>	432,80 <b>541,00</b>	477,60 <b>597,00</b>	485,60 <b>607,00</b>	460,80 <b>576,00</b>	485,60 <b>607,00</b>	501,60 <b>627,00</b>		481,60 <b>602,00</b>	510,40 <b>638,00</b>	530,40 <b>663,00</b>	510,40 <b>638,00</b>	551,20 <b>689,00</b>	612,00 <b>765,00</b>
<b>EFN 0022E</b>	Za ravne krovne pokrove do 16 mm (2 x 8 mm)	20-55	388,00 <b>485,00</b>	408,00 <b>510,00</b>	432,80 <b>541,00</b>	-	-	460,80 <b>576,00</b>	485,60 <b>607,00</b>	501,60 <b>627,00</b>		481,60 <b>602,00</b>	510,40 <b>638,00</b>	-	510,40 <b>638,00</b>	551,20 <b>689,00</b>	-

**ZA UGRADNJU TRIO KOMBINACIJE S VERTIKALNIM ELEMENTIMA**

**Standardna razina ugradnje (crvena razina)**

<b>EFW 0032B</b>	Za profilirane krovne pokrove do 120 mm	15-55	475,20 <b>594,00</b>	500,00 <b>625,00</b>	530,40 <b>663,00</b>	584,80 <b>731,00</b>	595,20 <b>744,00</b>	-	-	-		-	-	-	-	-	-
<b>EFW 0032C</b>	Za profilirane krovne pokrove do 120 mm	15-55	475,20 <b>594,00</b>	500,00 <b>625,00</b>	530,40 <b>663,00</b>	584,80 <b>731,00</b>	595,20 <b>744,00</b>	-	-	-		-	-	-	-	-	-
<b>EFW 0032E</b>	Za profilirane krovne pokrove do 120 mm	15-55	475,20 <b>594,00</b>	500,00 <b>625,00</b>	530,40 <b>663,00</b>	584,80 <b>731,00</b>	595,20 <b>744,00</b>	-	-	-		-	-	-	-	-	-
<b>EFS 0032B</b>	Za ravne krovne pokrove do 16 mm (2 x 8 mm)	15-55	565,60 <b>707,00</b>	595,20 <b>744,00</b>	630,40 <b>788,00</b>	696,00 <b>870,00</b>	708,00 <b>885,00</b>	-	-	-		-	-	-	-	-	-
<b>EFS 0032C</b>	Za ravne krovne pokrove do 16 mm (2 x 8 mm)	15-55	565,60 <b>707,00</b>	595,20 <b>744,00</b>	630,40 <b>788,00</b>	696,00 <b>870,00</b>	708,00 <b>885,00</b>	-	-	-		-	-	-	-	-	-
<b>EFS 0032E</b>	Za ravne krovne pokrove do 16 mm (2 x 8 mm)	15-55	565,60 <b>707,00</b>	595,20 <b>744,00</b>	630,40 <b>788,00</b>	696,00 <b>870,00</b>	708,00 <b>885,00</b>	-	-	-		-	-	-	-	-	-

**Razina upuštene ugradnje 40 mm dublje u krovnu konstrukciju (plava razina)**

<b>EFJ 0032E</b>	Za ravne ili profilirane materijale za krov s profilom do 90 mm	20-55	570,40 <b>713,00</b>	600,00 <b>750,00</b>	636,00 <b>795,00</b>	702,40 <b>878,00</b>	714,40 <b>893,00</b>	-	-	-		-	-	-	-	-	-
<b>EFN 0032E</b>	Za ravne krovne pokrove do 16 mm (2 x 8 mm)	20-55	570,40 <b>713,00</b>	600,00 <b>750,00</b>	636,00 <b>795,00</b>	-	-	-	-	-		-	-	-	-	-	-



Cijena bez PDV-a (€)  
Cijena s PDV-om (€)

MK34 78x92	PK34 94x92	SK34 114x92

#### FIKSNI DONJI ELEMENTI

		W/(m <sup>2</sup> K)	Nagib krova			
<b>GIL 3070</b>	Fiksno, borovo drvo, završno premazano u tri sloja, prozirni lak, dvostruko staklo	1.3	15-90	377,60 <b>472,00</b>	427,20 <b>534,00</b>	469,60 <b>587,00</b>
<b>GIL 3068</b>	Fiksno, borovo drvo, završno premazano u tri sloja, prozirni lak, trostruko staklo	1.1	15-90	472,00 <b>590,00</b>	534,40 <b>668,00</b>	587,20 <b>734,00</b>
<b>GIL 3066</b>	Fiksno, borovo drvo, završno premazano u tri sloja, prozirni lak, trostruko staklo	1.0	15-90	528,00 <b>660,00</b>	598,40 <b>748,00</b>	657,60 <b>822,00</b>
<b>GIU 0070</b>	Fiksno, bijeli poliuretani oblikovan oko drvene jezgre s dodatnim izdržljivim premazom, dvostruko staklo	1.3	15-90	426,40 <b>533,00</b>	483,20 <b>604,00</b>	530,40 <b>663,00</b>
<b>GIU 0068</b>	Fiksno, bijeli poliuretani oblikovan oko drvene jezgre s dodatnim izdržljivim premazom, trostruko staklo	1.1	15-90	532,80 <b>666,00</b>	604,00 <b>755,00</b>	663,20 <b>829,00</b>
<b>GIU 0066</b>	Fiksno, bijeli poliuretani oblikovan oko drvene jezgre s dodatnim izdržljivim premazom, trostruko staklo	1.0	15-90	596,80 <b>746,00</b>	676,80 <b>846,00</b>	742,40 <b>928,00</b>
<b>GIU 0062</b>	Fiksno, bijeli poliuretani oblikovan oko drvene jezgre s dodatnim izdržljivim premazom, trostruko staklo	1.0	15-90	741,60 <b>927,00</b>	840,80 <b>1.051,00</b>	923,20 <b>1.154,00</b>
<b>GIL 2070</b>	Fiksno, borovo drvo, završno premazano u tri sloja, obojeno bijelom bojom, dvostruko staklo	1.3	15-90	377,60 <b>472,00</b>	427,20 <b>534,00</b>	469,60 <b>587,00</b>
<b>GIL 2068</b>	Fiksno, borovo drvo, završno premazano u tri sloja, obojeno bijelom bojom, trostruko staklo	1.1	15-90	472,00 <b>590,00</b>	534,40 <b>668,00</b>	587,20 <b>734,00</b>
<b>GIL 2066</b>	Fiksno, borovo drvo, završno premazano u tri sloja, obojeno bijelom bojom, trostruko staklo	1.0	15-90	528,00 <b>660,00</b>	598,40 <b>748,00</b>	657,60 <b>822,00</b>
<b>GIL 2062</b>	Fiksno, borovo drvo, završno premazano u tri sloja, obojeno bijelom bojom, trostruko staklo	1.0	15-90	656,80 <b>821,00</b>	744,00 <b>930,00</b>	816,80 <b>1.021,00</b>

Fiksni element GIL dizajniran je za ugradnju direktno ispod okvira gornjih GGL, GPL i GLL krovni prozora, bez upotrebe dodatnog profila.  
Fiksni element GIL ne može se zasebno ugraditi.

Fiksni elementi GIU dizajniran je za ugradnju direktno ispod okvira gornjih GGU, GPU i GLU krovni prozora, bez upotrebe dodatnog profila.  
Fiksni element GIU ne može se zasebno ugraditi.

Cijena bez PDV-a (€)  
Cijena s PDV-om (€)

Veličine/Dimenzije (cm)

WK34  
+++x94

#### KOMBINACIJA KROVNOG PROZORA I FIKSNOG DONJEG ELEMENTA GIL ILI GIU

Za pojedinačnu ugradnju krovni prozora s fiksnim donjim elementom

Nagib krova

#### Standardna razina ugradnje (crvena razina)

<b>ETW 1000</b>	Za profilirane krovne pokrove do 120 mm	15-90	38,40 <b>48,00</b>
<b>ETW 1000S</b>	Za profilirane krovne pokrove do 120 mm	15-90	38,40 <b>48,00</b>
<b>ETW 2000</b>	Za profilirane krovne pokrove do 120 mm	15-90	38,40 <b>48,00</b>
<b>ETW 2000S</b>	Za profilirane krovne pokrove do 120 mm	15-90	38,40 <b>48,00</b>
<b>ETS 1000</b>	Za ravne krovne pokrove do 16 mm (2 x 8 mm)	15-90	38,40 <b>48,00</b>
<b>ETS 2000</b>	Za ravne krovne pokrove do 16 mm (2 x 8 mm)	15-90	38,40 <b>48,00</b>

Cijena bez PDV-a (€)  
Cijena s PDV-om (€)

Veličine/Dimenzije (cm)

WK34  
+++x94

#### ZA KOMBINIRANU UGRADNJU KROVNIH PROZORA S FIKSNIM DONJIM ELEMENTIMA

Nagib krova

#### Standardna razina ugradnje (crvena razina)

<b>ETW 2000M (F, G, H)*</b>	Za profilirane krovne pokrove do 120 mm	15-90	38,40 <b>48,00</b>
<b>ETS 2000M (F, G, H)*</b>	Za ravne krovne pokrove do 16 mm (2 x 8 mm)	15-90	38,40 <b>48,00</b>



Cijena bez PDV-a (€)  
Cijena s PDV-om (€)

		MK19	PK19	SK19		
KROVNI BALKON		W/(m <sup>2</sup> K)		Nagib krova		
<b>GDL 2066</b>	Ručno upravljanje, s donjom ručkom i dvostrukim ovjesom, borovo drvo, završno premazano u tri sloja, obojeno bijelom bojom, trostruko staklo	1.3	35-53	2.264,80 <b>2.831,00</b>	-	-
<b>GDL 3066</b>	Ručno upravljanje, s donjom ručkom i dvostrukim ovjesom, borovo drvo, završno premazano u tri sloja, prozirni lak, trostruko staklo	1.3	35-53	2.264,80 <b>2.831,00</b>	-	-
<b>GDL 2066</b>	Ručno upravljanje, s donjom ručkom i dvostrukim ovjesom, borovo drvo, završno premazano u tri sloja, obojeno bijelom bojom, trostruko staklo	1.1	35-53	-	2.435,20 <b>3.044,00</b>	-
<b>GDL 3066</b>	Ručno upravljanje, s donjom ručkom i dvostrukim ovjesom, borovo drvo, završno premazano u tri sloja, prozirni lak, trostruko staklo	1.1	35-53	-	2.435,20 <b>3.044,00</b>	-
<b>GDL 2066</b>	Ručno upravljanje, s donjom ručkom i dvostrukim ovjesom, borovo drvo, završno premazano u tri sloja, obojeno bijelom bojom, trostruko staklo	1.1	35-53	-	-	2.606,40 <b>3.258,00</b>
<b>GDL 3066</b>	Ručno upravljanje, s donjom ručkom i dvostrukim ovjesom, borovo drvo, završno premazano u tri sloja, prozirni lak, trostruko staklo	1.1	35-53	-	-	2.606,40 <b>3.258,00</b>

Za krovni balkon GDL u dimenziji MK19, U<sub>w</sub> = 1,3

Gornji element ima donju ručku pa se cijelo krilo otvara prema van dok se donji element otvaranjem pretvara u staklenu ogradu s bočnom čeličnom ogradicom. Kako biste oprali vanjsko staklo zarotirajte krilo prozora za 180°

Cijena bez PDV-a (€)  
Cijena s PDV-om (€)

			MK19 78x252	PK19 94x252	SK19 114x252
UGRADNJA KROVNOG BALKONA		Veličine/Dimenzije (cm)		Nagib krova	
<b>Set za ugradnju Basic 1000 koji sadrži BFX hidroizolacijsku maramicu i odvodni žlijeb</b>					
<b>EDW 1000</b>	Za profilirane krovne pokrove do 120 mm	35-53	151,20 <b>189,00</b>	164,00 <b>205,00</b>	169,60 <b>212,00</b>
<b>EDS 1000</b>	Za ravne krovne pokrove do 16 mm (2 x 8 mm)	35-53	151,20 <b>189,00</b>	164,00 <b>205,00</b>	169,60 <b>212,00</b>

Cijena bez PDV-a (€)  
Cijena s PDV-om (€)

			MK19 78x252	PK19 94x252	SK19 114x252
SET ZA UGRADNJU ENERGY 2000 KOJI SADRŽI BFX HIDROIZOLACIJSKU MARAMICU, ODVODNI ŽLIJEB I TOPLINSKU IZOLACIJU BDX		Veličine/Dimenzije (cm)		Nagib krova	
<b>EDW 2000</b>	Za profilirane krovne pokrove do 120 mm	35-53	176,00 <b>220,00</b>	190,40 <b>238,00</b>	197,60 <b>247,00</b>
<b>EDS 2000</b>	Za ravne krovne pokrove do 16 mm (2 x 8 mm)	35-53	176,00 <b>220,00</b>	190,40 <b>238,00</b>	197,60 <b>247,00</b>

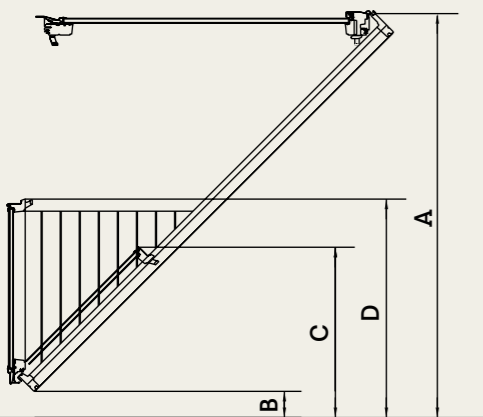

	A	B	C	D
Nagib krova	Gornji rub okvira prozora	Donji rub okvira prozora	Gornji rub donjeg krila prozora	Visina ograde
	cm	cm	cm	cm
53°	209	0	81	95
50°	201	0	79	95
45°	200	13	88	108
40°	200	28	98	123
35°	200	45	109	140

Ovisnost položaja donjeg krila prozora i visine ograde o nagibu krova.



Cijena bez PDV-a (€)  
Cijena s PDV-om (€)

M08  
78x140

M35  
78x109

KROVNA TERASA		W/(m <sup>2</sup> K)	Nagib krova		
GEL 2065	Otvaranje prema van, borovo drvo, završno premazano u tri sloja, obojeno bijelom bojom, trostruko staklo	1.0	35-53	1.233,60 <b>1.542,00</b>	-
GEL 3065	Otvaranje prema van, borovo drvo, završno premazano u tri sloja, prozirni lak, trostruko staklo	1.0	35-53	1.233,60 <b>1.542,00</b>	-
VEA 2065	Otvaranje prema van udesno, borovo drvo, završno premazano u tri sloja, obojeno bijelom bojom, trostruko staklo	1.0	35-53	-	1.041,60 <b>1.302,00</b>
VEA 3065	Otvaranje prema van udesno, borovo drvo, završno premazano u tri sloja, prozirni lak, trostruko staklo	1.0	35-53	-	1.041,60 <b>1.302,00</b>
VEB 2065	Otvaranje prema van ulijevo, borovo drvo, završno premazano u tri sloja, obojeno bijelom bojom, trostruko staklo	1.0	35-53	-	1.041,60 <b>1.302,00</b>
VEB 3065	Otvaranje prema van ulijevo, borovo drvo, završno premazano u tri sloja, prozirni lak, trostruko staklo	1.0	35-53	-	1.041,60 <b>1.302,00</b>
VEC 2065	Fiksno, borovo drvo, završno premazano u tri sloja, obojeno bijelom bojom, trostruko staklo	1.0	35-53	-	964,00 <b>1.205,00</b>
VEC 3065	Fiksno, borovo drvo, završno premazano u tri sloja, prozirni lak, trostruko staklo	1.0	35-53	-	964,00 <b>1.205,00</b>

GEL krovna terasa može se sastojati od vertikalno otvarajućeg VEA/B donjeg elementa ili fiksnog VEC donjeg elementa.  
Kada kombinirate više od jedne krovne terase, samo jedan donji element može se otvoriti.

Dimenzija VELUX krovne terase ovisi o nagibu krova

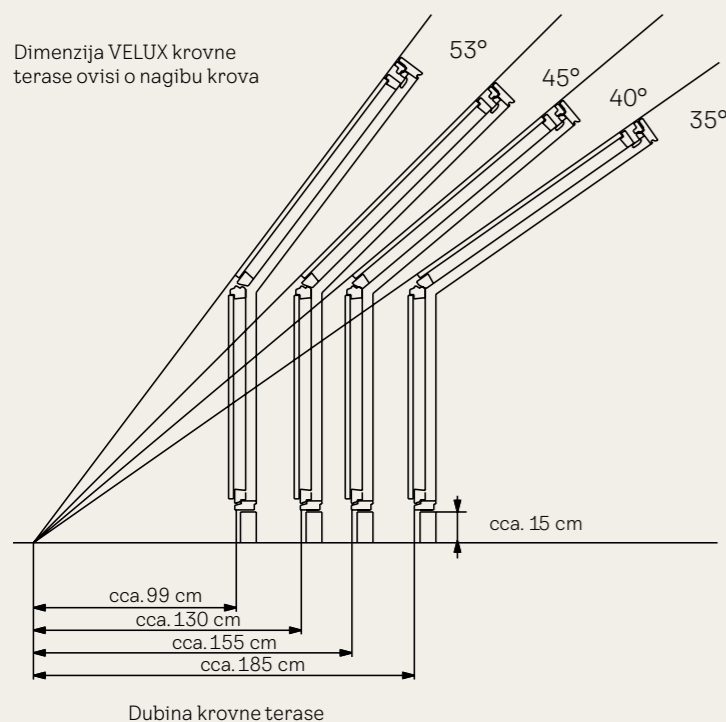

Dva zaokretna vertikalna krila ne mogu biti ugrađena jedno pored drugog. Okovi elemenata VEA/VEB uvijek moraju biti ugrađeni na rogove krovne konstrukcije.

Cijena bez PDV-a (€)  
Cijena s PDV-om (€)

Veličine/Dimenzije (cm)

M08  
78x140

M35  
78x109

KOMBINACIJA KROVNA TERASA		Nagib krova			
<b>Pojedinačna ugradnja krovna terasa</b>					
EEW 0000	Za profilirane krovne pokrove do 120 mm	35-53	156,00 <b>195,00</b>	-	
EES 0000	Za ravne krovne pokrove do 16 mm (2 x 8 mm)	35-53	156,00 <b>195,00</b>	-	
EEX 0000		35-53	-	156,00 <b>195,00</b>	

Cijena bez PDV-a (€)  
Cijena s PDV-om (€)

Veličine/Dimenzije (cm)

M08  
78x140

KOMBINIRANA UGRADNJA KROVNA TERASA		Nagib krova			
EEW 0001E	Za profilirane krovne pokrove do 120 mm	35-53	156,00 <b>195,00</b>		
EEW 0002E	Za profilirane krovne pokrove do 120 mm	35-53	156,00 <b>195,00</b>		
EEW 0003	Za profilirane krovne pokrove do 120 mm	35-53	156,00 <b>195,00</b>		
EES 0001E	Za ravne krovne pokrove do 16 mm (2 x 8 mm)	35-53	156,00 <b>195,00</b>		
EES 0002E	Za ravne krovne pokrove do 16 mm (2 x 8 mm)	35-53	156,00 <b>195,00</b>		
EES 0003	Za ravne krovne pokrove do 16 mm (2 x 8 mm)	35-53	156,00 <b>195,00</b>		



Cijena bez PDV-a (€)  
Cijena s PDV-om (€)

FFKF06  
188x118

FFKF08  
188x140

### KROVNI PROZOR 3U1

		W/(m <sup>2</sup> K)	Nagib krova		
<b>GGLS 2066</b>	Ručno upravljanje, s gornjom ručkom, borovo drvo, završno premazano u tri sloja, obojeno bijelom bojom, trostruko staklo	1.0-1.1	15-90	1.411,20 <b>1.764,00</b>	1.650,40 <b>2.063,00</b>
<b>GGLS 206630</b>	Solarni, borovo drvo, završno premazano u tri sloja, obojeno bijelom bojom, trostruko staklo	1.0-1.1	15-90	2.182,40 <b>2.728,00</b>	2.421,60 <b>3.027,00</b>
<b>GGLS 2070</b>	Ručno upravljanje, s gornjom ručkom, borovo drvo, završno premazano u tri sloja, obojeno bijelom bojom, dvostruko staklo	1.3-1.4	15-90	1.008,00 <b>1.260,00</b>	1.178,40 <b>1.473,00</b>
<b>GGLS 207030</b>	Solarni, borovo drvo, završno premazano u tri sloja, obojeno bijelom bojom, dvostruko staklo	1.3-1.4	15-90	1.779,20 <b>2.224,00</b>	1.949,60 <b>2.437,00</b>
<b>GPLS 2066</b>	Ručno upravljanje, s donjom ručkom i dvostrukim ovjesom, borovo drvo, završno premazano u tri sloja, obojeno bijelom bojom, trostruko staklo	1.1-1.2	15-55	1.825,60 <b>2.282,00</b>	2.064,80 <b>2.581,00</b>
<b>GPLS 2070</b>	Ručno upravljanje, s donjom ručkom i dvostrukim ovjesom, borovo drvo, završno premazano u tri sloja, obojeno bijelom bojom, dvostruko staklo	1.3-1.4	15-55	1.422,40 <b>1.778,00</b>	1.592,80 <b>1.991,00</b>

Cijena bez PDV-a (€)  
Cijena s PDV-om (€)

FFKF06  
188x118

FFKF08  
188x140

### OPŠAVI

		Nagib krova		
<b>EDWS 2000</b>		15-90	338,40 <b>423,00</b>	360,00 <b>450,00</b>
<b>EDLS 2000</b>		15-90	338,40 <b>423,00</b>	360,00 <b>450,00</b>

EDWS i EDLS opšavi uključuju BDZ izolacijski okvir i BFX hidroizolacijsku maramicu.

## Setovi opšava

Cijena bez PDV-a (€)		CK02	CK04	CK06	FK04	FK06	FK08	MK04	MK06		MK08	MK10	PK06	PK08	PK10	SK06	SK08	SK10	UK04	UK08	UK10
Cijena s PDV-om (€)	Veličine/Dimenzije (cm)	55x78	55x98	55x118	66x98	66x118	66x140	78x98	78x118		78x140	78x160	94x118	94x140	94x160	114x118	114x140	114x160	134x98	134x140	134x160
<b>OPŠAVI SA KOMPLETNOM TERMO I PARNOM ZAŠTITOM</b>																					
EDJ 2000 + BBX 0000	EDJ S00J01	174,40 <b>218,00</b>	179,20 <b>224,00</b>	184,80 <b>231,00</b>	184,80 <b>231,00</b>	198,40 <b>248,00</b>	208,80 <b>261,00</b>	198,40 <b>248,00</b>	208,00 <b>260,00</b>		220,00 <b>275,00</b>	240,00 <b>300,00</b>	232,00 <b>290,00</b>	243,20 <b>304,00</b>	252,00 <b>315,00</b>	241,60 <b>302,00</b>	256,00 <b>320,00</b>	264,80 <b>331,00</b>	-	274,40 <b>343,00</b>	301,60 <b>377,00</b>
EDS 2000 + BBX 0000	EDS S00S01	150,40 <b>188,00</b>	154,40 <b>193,00</b>	159,20 <b>199,00</b>	159,20 <b>199,00</b>	170,40 <b>213,00</b>	179,20 <b>224,00</b>	170,40 <b>213,00</b>	178,40 <b>223,00</b>		188,80 <b>236,00</b>	205,60 <b>257,00</b>	199,20 <b>249,00</b>	208,80 <b>261,00</b>	216,00 <b>270,00</b>	207,20 <b>259,00</b>	219,20 <b>274,00</b>	227,20 <b>284,00</b>	220,00 <b>275,00</b>	235,20 <b>294,00</b>	258,40 <b>323,00</b>
EDW 2000 + BBX 0000	EDW S00W01	150,40 <b>188,00</b>	154,40 <b>193,00</b>	159,20 <b>199,00</b>	159,20 <b>199,00</b>	170,40 <b>213,00</b>	179,20 <b>224,00</b>	170,40 <b>213,00</b>	178,40 <b>223,00</b>		188,80 <b>236,00</b>	205,60 <b>257,00</b>	199,20 <b>249,00</b>	208,80 <b>261,00</b>	216,00 <b>270,00</b>	207,20 <b>259,00</b>	219,20 <b>274,00</b>	227,20 <b>284,00</b>	220,00 <b>275,00</b>	235,20 <b>294,00</b>	258,40 <b>323,00</b>

VELUX rješenja za ugradnju dizajnirana su za savršenu integraciju vaših VELUX krovnih prozora u pokrovni materijal. Osiguravaju potpunu zaštitu izvana i iznutra za sve vremenske uvjete, pa čak i većinu uvjeta s unutarnjom vlagom.

Setovi se sastoje od rješenja za ugradnju Energy koji uključuje BDZ termoizolacijski okvir i BFX hidroizolacijsku maramicu te VELUX parnu branu BBX.

Kupite set  
i uštedite

# PROIZVODI ZA UGRADNJU KROVNIH PROZORA

Cijena bez PDV-a (€)		CK02	CK04	CK06	FK04	FK06	FK08	MK04	MK06	MK08	MK10	MK12	PK06	PK08	PK10	SK06	SK08	SK10	UK04	UK08	UK10	
Cijena s PDV-om (€)		55x78	55x98	55x118	66x98	66x118	66x140	78x98	78x118	78x140	78x160	78x180	94x118	94x140	94x160	114x118	114x140	114x160	134x98	134x140	134x160	
Veličine/Dimenzije (cm)																						
<b>PROIZVODI ZA UGRADNJU KROVNIH PROZORA</b>																						
<b>Set za ugradnju BDX sastoji se od termoizolacijskog okvira BDX, hidroizolacijske maramice BFX i odvodnog žlijeba (BDX WK34 ne sadrži odvodni žlijeb)</b>																						
<b>BDX 2000</b>	VELUX set za ugradnju BDX, pojedinačna ugradnja	50,40 <b>63,00</b>	52,80 <b>66,00</b>	55,20 <b>69,00</b>	54,40 <b>68,00</b>	57,60 <b>72,00</b>	60,00 <b>75,00</b>	57,60 <b>72,00</b>	60,00 <b>75,00</b>		63,20 <b>79,00</b>	64,80 <b>81,00</b>	71,20 <b>89,00</b>	63,20 <b>79,00</b>	64,80 <b>81,00</b>	68,00 <b>85,00</b>	65,60 <b>82,00</b>	68,00 <b>85,00</b>	71,20 <b>89,00</b>	65,60 <b>82,00</b>	71,20 <b>89,00</b>	73,60 <b>92,00</b>
<b>BDX 2000F</b>	VELUX set za ugradnju BDX, pojedinačna upuštena ugradnja	57,60 <b>72,00</b>	60,80 <b>76,00</b>	63,20 <b>79,00</b>	62,40 <b>78,00</b>	66,40 <b>83,00</b>	68,80 <b>86,00</b>	66,40 <b>83,00</b>	68,80 <b>86,00</b>		72,80 <b>91,00</b>	74,40 <b>93,00</b>	81,60 <b>102,00</b>	72,80 <b>91,00</b>	74,40 <b>93,00</b>	77,60 <b>97,00</b>	75,20 <b>94,00</b>	77,60 <b>97,00</b>	82,40 <b>103,00</b>	75,20 <b>94,00</b>	81,60 <b>102,00</b>	84,00 <b>105,00</b>
<b>BDX 2011</b>	VELUX set za ugradnju BDX za potpurnu gredu EBY	100,00 <b>125,00</b>	104,80 <b>131,00</b>	109,60 <b>137,00</b>	107,20 <b>134,00</b>	114,40 <b>143,00</b>	119,20 <b>149,00</b>	114,40 <b>143,00</b>	119,20 <b>149,00</b>		124,80 <b>156,00</b>	128,00 <b>160,00</b>	140,00 <b>175,00</b>	124,80 <b>156,00</b>	128,00 <b>160,00</b>	134,40 <b>168,00</b>	129,60 <b>162,00</b>	134,40 <b>168,00</b>	141,60 <b>177,00</b>	129,60 <b>162,00</b>	140,00 <b>175,00</b>	144,80 <b>181,00</b>
<b>BDX 2011E</b>	VELUX set za ugradnju BDX za potpurnu gredu EKY	104,80 <b>131,00</b>	109,60 <b>137,00</b>	115,20 <b>144,00</b>	112,00 <b>140,00</b>	120,00 <b>150,00</b>	124,80 <b>156,00</b>	120,00 <b>150,00</b>	124,80 <b>156,00</b>		131,20 <b>164,00</b>	134,40 <b>168,00</b>	147,20 <b>184,00</b>	131,20 <b>164,00</b>	134,40 <b>168,00</b>	140,80 <b>176,00</b>	136,00 <b>170,00</b>	140,80 <b>176,00</b>	148,80 <b>186,00</b>	136,00 <b>170,00</b>	147,20 <b>184,00</b>	152,00 <b>190,00</b>
<b>BDX 4021B</b>	VELUX set za ugradnju BDX za side-by-side	170,40 <b>213,00</b>	174,40 <b>218,00</b>	180,00 <b>225,00</b>	180,00 <b>225,00</b>	194,40 <b>243,00</b>	204,80 <b>256,00</b>	194,40 <b>243,00</b>	204,80 <b>256,00</b>		217,60 <b>272,00</b>	240,00 <b>300,00</b>	244,00 <b>305,00</b>	232,00 <b>290,00</b>	244,00 <b>305,00</b>	252,00 <b>315,00</b>	241,60 <b>302,00</b>	256,00 <b>320,00</b>	266,40 <b>333,00</b>	256,00 <b>320,00</b>	276,80 <b>346,00</b>	-
<b>BDX 4021E</b>	VELUX set za ugradnju BDX za side-by-side	182,40 <b>228,00</b>	186,40 <b>233,00</b>	193,60 <b>242,00</b>	193,60 <b>242,00</b>	208,80 <b>261,00</b>	220,00 <b>275,00</b>	208,80 <b>261,00</b>	220,00 <b>275,00</b>		232,80 <b>291,00</b>	256,80 <b>321,00</b>	261,60 <b>327,00</b>	248,00 <b>310,00</b>	261,60 <b>327,00</b>	270,40 <b>338,00</b>	259,20 <b>324,00</b>	274,40 <b>343,00</b>	285,60 <b>357,00</b>	274,40 <b>343,00</b>	296,80 <b>371,00</b>	-
<b>BDX 4021EF</b>	VELUX set za ugradnju BDX za prozore u upuštenoj ugradnji	182,40 <b>228,00</b>	186,40 <b>233,00</b>	193,60 <b>242,00</b>	193,60 <b>242,00</b>	208,80 <b>261,00</b>	220,00 <b>275,00</b>	208,80 <b>261,00</b>	220,00 <b>275,00</b>		232,80 <b>291,00</b>	256,80 <b>321,00</b>	261,60 <b>327,00</b>	248,00 <b>310,00</b>	261,60 <b>327,00</b>	270,40 <b>338,00</b>	259,20 <b>324,00</b>	274,40 <b>343,00</b>	285,60 <b>357,00</b>	274,40 <b>343,00</b>	296,80 <b>371,00</b>	-
<b>BDX 4031B</b>	VELUX set za ugradnju BDX za side-by-side	288,80 <b>361,00</b>	296,00 <b>370,00</b>	306,40 <b>383,00</b>	306,40 <b>383,00</b>	331,20 <b>414,00</b>	348,80 <b>436,00</b>	331,20 <b>414,00</b>	348,80 <b>436,00</b>		369,60 <b>462,00</b>	408,00 <b>510,00</b>	414,40 <b>518,00</b>	-	-	-	-	-	-	-	-	-
<b>Hidroizolacijska maramica BFX napravljena je od paropropusnog materijala koji zatvara prostor između krovnog prozora hidroizolacije krova</b>																						
<b>BFX 1000</b>	VELUX hidroizolacijska maramica BFX, pojedinačna ugradnja	26,40 <b>33,00</b>	27,20 <b>34,00</b>	28,80 <b>36,00</b>	28,00 <b>35,00</b>	29,60 <b>37,00</b>	31,20 <b>39,00</b>	29,60 <b>37,00</b>	31,20 <b>39,00</b>		32,80 <b>41,00</b>	33,60 <b>42,00</b>	36,80 <b>46,00</b>	32,80 <b>41,00</b>	33,60 <b>42,00</b>	35,20 <b>44,00</b>	34,40 <b>43,00</b>	35,20 <b>44,00</b>	36,80 <b>46,00</b>	34,40 <b>43,00</b>	36,80 <b>46,00</b>	38,40 <b>48,00</b>
<b>BFX 1000F</b>	VELUX hidroizolacijska maramica BFX, pojedinačna upuštena ugradnja	27,20 <b>34,00</b>	28,80 <b>36,00</b>	29,60 <b>37,00</b>	28,80 <b>36,00</b>	31,20 <b>39,00</b>	32,80 <b>41,00</b>	31,20 <b>39,00</b>	32,80 <b>41,00</b>		34,40 <b>43,00</b>	35,20 <b>44,00</b>	38,40 <b>48,00</b>	34,40 <b>43,00</b>	35,20 <b>44,00</b>	36,80 <b>46,00</b>	35,20 <b>44,00</b>	36,80 <b>46,00</b>	38,40 <b>48,00</b>	35,20 <b>44,00</b>	38,40 <b>48,00</b>	39,20 <b>49,00</b>
<b>Parna brana BBX osigurava čvrst vezu između krovnog prozora i postojeće parne brane</b>																						
<b>BBX 0021B</b>	VELUX parna brana BBX za prozore koji se postavljaju u obrubljenu ugradnju	70,40 <b>88,00</b>	72,00 <b>90,00</b>	73,60 <b>92,00</b>	73,60 <b>92,00</b>	75,20 <b>94,00</b>	78,40 <b>98,00</b>	75,20 <b>94,00</b>	76,80 <b>96,00</b>		80,00 <b>100,00</b>	82,40 <b>103,00</b>	107,20 <b>134,00</b>	80,00 <b>100,00</b>	81,60 <b>102,00</b>	84,00 <b>105,00</b>	82,40 <b>103,00</b>	84,00 <b>105,00</b>	86,40 <b>108,00</b>	85,60 <b>107,00</b>	87,20 <b>109,00</b>	-
<b>BBX 0021E</b>	VELUX parna brana BBX za prozore koji se postavljaju u obrubljenu ugradnju	70,40 <b>88,00</b>	72,00 <b>90,00</b>	73,60 <b>92,00</b>	73,60 <b>92,00</b>	75,20 <b>94,00</b>	78,40 <b>98,00</b>	75,20 <b>94,00</b>	76,80 <b>96,00</b>		80,00 <b>100,00</b>	82,40 <b>103,00</b>	107,20 <b>134,00</b>	80,00 <b>100,00</b>	81,60 <b>102,00</b>	84,00 <b>105,00</b>	82,40 <b>103,00</b>	84,00 <b>105,00</b>	86,40 <b>108,00</b>	85,60 <b>107,00</b>	87,20 <b>109,00</b>	-
<b>BBX 0000</b>	VELUX parna brana BBX	-	36,00 <b>45,00</b>	36,80 <b>46,00</b>	36,80 <b>46,00</b>	37,60 <b>47,00</b>	39,20 <b>49,00</b>	37,60 <b>47,00</b>	38,40 <b>48,00</b>		40,00 <b>50,00</b>	40,80 <b>51,00</b>	53,60 <b>67,00</b>	40,00 <b>50,00</b>	40,80 <b>51,00</b>	42,40 <b>53,00</b>	40,80 <b>51,00</b>	42,40 <b>53,00</b>	43,20 <b>54,00</b>	43,20 <b>54,00</b>	44,00 <b>55,00</b>	44,80 <b>56,00</b>



Cijena bez PDV-a (€) Cijena s PDV-om (€)																							
		Veličine/Dimenzije (cm)	CKO2 55x78	CKO4 55x98	CKO6 55x118	FKO4 66x98	FKO6 66x118	FKO8 66x140	MKO4 78x98	MKO6 78x118		MKO8 78x140	MK12 78x180	PKO6 94x118	PKO8 94x140	PK10 94x160	SKO6 114x118	SKO8 114x140	SK10 114x160	UKO4 134x98	UKO8 134x140	UK10 134x160	
<b>UNUTARNJA OBLOGA</b>																							
Nagib krova																							
<b>Unutarnja obloga zatvara prostor između krovnog prozora i stropa, napravljena je od pjenastog PVC sa završnim bijelim lakom</b>																							
<b>LSB 2000</b>	VELUX obloga LSB za debljinu krova do 300 mm, pojedinačna ugradnja	15-90	207,20 <b>259,00</b>	212,00 <b>265,00</b>	216,80 <b>271,00</b>	216,80 <b>271,00</b>	220,80 <b>276,00</b>	230,40 <b>288,00</b>	220,80 <b>276,00</b>	225,60 <b>282,00</b>		234,40 <b>293,00</b>	316,00 <b>395,00</b>	234,40 <b>293,00</b>	239,20 <b>299,00</b>	248,00 <b>310,00</b>	241,60 <b>302,00</b>	248,00 <b>310,00</b>	255,20 <b>319,00</b>	252,80 <b>316,00</b>	256,80 <b>321,00</b>	264,00 <b>330,00</b>	
<b>LSB 2021B</b>	VELUX obloga LSB, dvostruka ugradnja	15-90	415,20 <b>519,00</b>	424,00 <b>530,00</b>	432,80 <b>541,00</b>	432,80 <b>541,00</b>	442,40 <b>553,00</b>	460,00 <b>575,00</b>	442,40 <b>553,00</b>	451,20 <b>564,00</b>		469,60 <b>587,00</b>	632,00 <b>790,00</b>	469,60 <b>587,00</b>	478,40 <b>598,00</b>	496,00 <b>620,00</b>	482,40 <b>603,00</b>	496,00 <b>620,00</b>	509,60 <b>637,00</b>	505,60 <b>632,00</b>	514,40 <b>643,00</b>	528,00 <b>660,00</b>	
<b>LSB 2021E</b>	VELUX obloga LSB, kombinirana ugradnja	15-90	415,20 <b>519,00</b>	424,00 <b>530,00</b>	432,80 <b>541,00</b>	432,80 <b>541,00</b>	442,40 <b>553,00</b>	460,00 <b>575,00</b>	442,40 <b>553,00</b>	451,20 <b>564,00</b>		469,60 <b>587,00</b>	632,00 <b>790,00</b>	469,60 <b>587,00</b>	478,40 <b>598,00</b>	496,00 <b>620,00</b>	482,40 <b>603,00</b>	496,00 <b>620,00</b>	509,60 <b>637,00</b>	505,60 <b>632,00</b>	514,40 <b>643,00</b>	528,00 <b>660,00</b>	
<b>LSB 2031B</b>	VELUX obloga LSB, trostruka ugradnja	15-90	622,40 <b>778,00</b>	636,00 <b>795,00</b>	649,60 <b>812,00</b>	649,60 <b>812,00</b>	663,20 <b>829,00</b>	690,40 <b>863,00</b>	663,20 <b>829,00</b>	676,80 <b>846,00</b>		704,00 <b>880,00</b>	947,20 <b>1.184,00</b>	-	-	-	-	-	-	-	-	-	-
<b>LSB 2031E</b>	VELUX obloga LSB, trostruka ugradnja	15-90	622,40 <b>778,00</b>	636,00 <b>795,00</b>	649,60 <b>812,00</b>	649,60 <b>812,00</b>	663,20 <b>829,00</b>	690,40 <b>863,00</b>	663,20 <b>829,00</b>	676,80 <b>846,00</b>		704,00 <b>880,00</b>	947,20 <b>1.184,00</b>	-	-	-	-	-	-	-	-	-	-
<b>LSC 2000</b>	VELUX obloga LSC za debljinu krova do 400 mm, pojedinačna ugradnja	15-90	259,20 <b>324,00</b>	264,80 <b>331,00</b>	270,40 <b>338,00</b>	270,40 <b>338,00</b>	276,00 <b>345,00</b>	288,00 <b>360,00</b>	276,00 <b>345,00</b>	282,40 <b>353,00</b>		293,60 <b>367,00</b>	395,20 <b>494,00</b>	293,60 <b>367,00</b>	299,20 <b>374,00</b>	310,40 <b>388,00</b>	301,60 <b>377,00</b>	310,40 <b>388,00</b>	318,40 <b>398,00</b>	316,00 <b>395,00</b>	321,60 <b>402,00</b>	329,60 <b>412,00</b>	
<b>LSC 2021B</b>	VELUX obloga LSC, dvostruka ugradnja	15-90	519,20 <b>649,00</b>	530,40 <b>663,00</b>	541,60 <b>677,00</b>	541,60 <b>677,00</b>	552,80 <b>691,00</b>	575,20 <b>719,00</b>	552,80 <b>691,00</b>	564,00 <b>705,00</b>		586,40 <b>733,00</b>	789,60 <b>987,00</b>	586,40 <b>733,00</b>	597,60 <b>747,00</b>	620,80 <b>776,00</b>	603,20 <b>754,00</b>	620,80 <b>776,00</b>	637,60 <b>797,00</b>	632,00 <b>790,00</b>	643,20 <b>804,00</b>	660,00 <b>825,00</b>	
<b>LSC 2021E</b>	VELUX obloga LSC, kombinirana ugradnja	15-90	519,20 <b>649,00</b>	530,40 <b>663,00</b>	541,60 <b>677,00</b>	541,60 <b>677,00</b>	552,80 <b>691,00</b>	575,20 <b>719,00</b>	552,80 <b>691,00</b>	564,00 <b>705,00</b>		586,40 <b>733,00</b>	789,60 <b>987,00</b>	586,40 <b>733,00</b>	597,60 <b>747,00</b>	620,80 <b>776,00</b>	603,20 <b>754,00</b>	620,80 <b>776,00</b>	637,60 <b>797,00</b>	632,00 <b>790,00</b>	643,20 <b>804,00</b>	660,00 <b>825,00</b>	
<b>LSC 2031B</b>	VELUX obloga LSC, dvostruka ugradnja	15-90	778,40 <b>973,00</b>	795,20 <b>994,00</b>	812,00 <b>1.015,00</b>	812,00 <b>1.015,00</b>	828,80 <b>1.036,00</b>	863,20 <b>1.079,00</b>	828,80 <b>1.036,00</b>	846,40 <b>1.058,00</b>		880,00 <b>1.100,00</b>	1.184,80 <b>1.481,00</b>	-	-	-	-	-	-	-	-	-	-
<b>LSD 2000</b>	VELUX obloga LSD za debljinu krova do 500 mm, pojedinačna ugradnja	15-90	352,80 <b>441,00</b>	360,80 <b>451,00</b>	368,00 <b>460,00</b>	368,00 <b>460,00</b>	376,00 <b>470,00</b>	391,20 <b>489,00</b>	376,00 <b>470,00</b>	383,20 <b>479,00</b>		399,20 <b>499,00</b>	536,80 <b>671,00</b>	399,20 <b>499,00</b>	406,40 <b>508,00</b>	421,60 <b>527,00</b>	410,40 <b>513,00</b>	421,60 <b>527,00</b>	433,60 <b>542,00</b>	429,60 <b>537,00</b>	437,60 <b>547,00</b>	448,80 <b>561,00</b>	
<b>LSD 2021B</b>	VELUX obloga LSD, dvostruka ugradnja	15-90	415,20 <b>519,00</b>	424,00 <b>530,00</b>	432,80 <b>541,00</b>	432,80 <b>541,00</b>	442,40 <b>553,00</b>	460,00 <b>575,00</b>	442,40 <b>553,00</b>	451,20 <b>564,00</b>		469,60 <b>587,00</b>	632,00 <b>790,00</b>	-	-	-	-	-	-	-	-	-	-
<b>LSD 2021E</b>	VELUX obloga LSD, kombinirana ugradnja	15-90	415,20 <b>519,00</b>	424,00 <b>530,00</b>	432,80 <b>541,00</b>	432,80 <b>541,00</b>	442,40 <b>553,00</b>	460,00 <b>575,00</b>	442,40 <b>553,00</b>	451,20 <b>564,00</b>		469,60 <b>587,00</b>	632,00 <b>790,00</b>	-	-	-	-	-	-	-	-	-	-

LSB, LSC, LSD obloga je kompatibilna s prethodnom i novom generacijom VELUX krovnih prozora.

Cijena bez PDV-a (€) Cijena s PDV-om (€)																							
		Veličine/Dimenzije (cm)	CKO2 55x78	CKO4 55x98	CKO6 55x118	FKO4 66x98	FKO6 66x118	FKO8 66x140	MKO4 78x98	MKO6 78x118		MKO8 78x140	MK10 78x160	MK12 78x180	PKO6 94x118	PKO8 94x140	PK10 94x160	SKO6 114x118	SKO8 114x140	SK10 114x160	UKO4 134x98	UKO8 134x140	UK10 134x160
<b>POKROVNI PROFILI S PRODUŽETKOM ZA POKROVNU KAPU</b>																							
Nagib krova																							
<b>ZWC 0000</b>	Ovaj set za prekrivanje, koji sadrži pokrivala bočnih i donjih okvira, potreban je ako želite ugraditi VELUX krovni prozor bez korištenja VELUX opšava.	-	30,40 <b>38,00</b>	32,80 <b>41,00</b>	36,00 <b>45,00</b>	36,00 <b>45,00</b>	37,60 <b>47,00</b>	41,60 <b>52,00</b>	36,80 <b>46,00</b>	40,00 <b>50,00</b>		43,20 <b>54,00</b>	49,60 <b>62,00</b>	56,80 <b>71,00</b>	47,20 <b>59,00</b>	50,40 <b>63,00</b>	54,40 <b>68,00</b>	49,60 <b>62,00</b>	55,20 <b>69,00</b>	60,80 <b>76,00</b>	50,40 <b>63,00</b>	61,60 <b>77,00</b>	68,80 <b>86,00</b>
<b>ZWC 0000T</b>	Ovaj set za prekrivanje, koji sadrži pokrivala bočnih i donjih okvira kao i produžni komad za krovnu kapu, potreban je ako želite ugraditi VELUX krovni prozor bez korištenja VELUX opšava.	-	30,40 <b>38,00</b>	32,80 <b>41,00</b>	36,00 <b>45,00</b>	36,00 <b>45,00</b>	37,60 <b>47,00</b>	41,60 <b>52,00</b>	36,80 <b>46,00</b>	40,00 <b>50,00</b>		43,20 <b>54,00</b>	49,60 <b>62,00</b>	56,80 <b>71,00</b>	47,20 <b>59,00</b>	50,40 <b>63,00</b>	54,40 <b>68,00</b>	49,60 <b>62,00</b>	55,20 <b>69,00</b>	60,80 <b>76,00</b>	50,40 <b>63,00</b>	61,60 <b>77,00</b>	68,80 <b>86,00</b>

# SJENILA I ROLETE

Za krovne prozore proizvedene od 2014.																						
Šifra prozora	CK02	CK04	CK06	FK04	FK06	FK08	MK04	MK06		MK08	MK10	MK12	PK06	PK08	PK10	SK06	SK08	SK10	UK04	UK08	UK10	
Vanjske rolete	CK02	CK04	CK06	FK04	FK06	FK08	MK04	MK06		MK08	MK10	MK12	PK06	PK08	PK10	SK06	SK08	SK10	UK04	UK08	UK10	
Sjenila i tende s vodilicama	CK02	CK04	CK06	FK04	FK06	FK08	MK04	MK06		MK08	MK10	MK12	PK06	PK08	PK10	SK06	SK08	SK10	UK04	UK08	UK10	
Sjenila i tende s kucicama	CK00	CK00	CK00	FK00	FK00	FK00	MK00	MK00		MK00	MK00	MK12	PK00	PK00	PK00	SK00	SK00	SK00	UK00	UK00	UK00	
Za krovne prozore proizvedene 2003.-2014.																						
Šifra prozora	C02	C04	C06	F04	F06	F08	M04	M06		M08	M10	M12	P06	P08	P10	S06	S08	S10	U04	U08	U10	
Vanjske rolete	CK02	CK04	CK06	FK04	FK06	FK08	MK04	MK06		MK08	MK10	MK12	PK06	PK08	PK10	SK06	SK08	SK10	UK04	UK08	UK10	
Sjenila i tende s vodilicama	C02	C04	C06	F04	F06	F08	M04	M06		M08	M10	M12	P06	P08	P10	S06	S08	S10	U04	U08	U10	
Sjenila i tende s kucicama	CK00	CK00	CK00	FK00	FK00	FK00	MK00	MK00		MK00	MK00	MK12	PK00	PK00	PK00	SK00	SK00	SK10	UK00	UK00	UK00	
Za krovne prozore proizvedene 1992.-2003.																						
Šifra prozora	102	104	-	204	206	-	304	306		308	310	-	406	408	410	606	608	610	804	808	810	
Vanjske rolete	CK02	CK04	-	FK04	FK06	-	MK04	MK06		MK08	MK10	-	PK06	PK08	PK10	SK06	SK08	SK10	UK04	UK08	UK10	
Sjenila i tende s vodilicama	102	104	-	204	206	-	M04	M06		M08	M10	-	P06	P08	P10	S06	S08	S10	U04	U08	U10	
Sjenila i tende s kucicama	100	100	-	200	200	-	MK00	MK00		MK00	MK00	-	PK00	PK00	PK00	SK00	SK00	SK00	UK00	UK00	UK00	
Oznaka	Upravljanje	Boja																				
		Dimenzija prozora (cm)																				
		55x78	55x98	55x118	66x98	66x118	66x140	78x98	78x118		78x140	78x160	78x180	94x118	94x140	94x160	114x118	114x140	114x160	134x98	134x140	134x160
Cijena bez PDV-a (€)		CK02	CK04	CK06	FK04	FK06	FK08	MK04	MK06		MK08	MK10	MK12	PK06	PK08	PK10	SK06	SK08	SK10	UK04	UK08	UK10
Cijena s PDV-om (€)		CK02	CK04	CK06	FK04	FK06	FK08	MK04	MK06		MK08	MK10	MK12	PK06	PK08	PK10	SK06	SK08	SK10	UK04	UK08	UK10

## UNUTARNJA DEKORACIJA I KONTROLA SVJETLOSTI

Unutarnji rolo za zasjenjenje s bočnim stoperima

RHL	Ručno upravljanje	Standard	40,00	50,00	46,40	58,00	49,60	62,00	49,60	62,00	-	57,60	72,00	64,00	80,00	69,60	87,00
-----	-------------------	----------	-------	-------	-------	-------	-------	-------	-------	-------	---	-------	-------	-------	-------	-------	-------

Unutarnji rolo za zasjenjenje

RFL	Ručno upravljanje	Standard	68,00	73,60	80,00	79,20	85,60	89,60	83,20	89,60	95,20	107,20	116,00	98,40	107,20	113,60	112,00	116,00	129,60	114,40	131,20	137,60
	Ručno upravljanje	Trend, Colour by You	85,00	92,00	100,00	99,00	107,00	112,00	104,00	112,00	119,00	134,00	145,00	123,00	134,00	142,00	140,00	145,00	162,00	143,00	164,00	172,00
RFY	Ručno upravljanje	Kolekcija Nature	81,60	87,20	93,60	92,80	99,20	103,20	96,80	103,20	108,80	120,80	129,60	112,00	120,80	127,20	125,60	129,60	143,20	128,00	144,80	151,20
	Ručno upravljanje	Kolekcija Nature	102,00	109,00	117,00	116,00	124,00	129,00	121,00	129,00	136,00	151,00	162,00	140,00	151,00	159,00	157,00	162,00	179,00	160,00	181,00	189,00
RML	Ručno upravljanje	Kolekcija Nature	88,80	95,20	103,20	101,60	108,80	112,80	105,60	112,80	120,00	132,80	142,40	122,40	132,80	139,20	137,60	142,40	157,60	140,80	159,20	166,40
	Ručno upravljanje	Kolekcija Nature	111,00	119,00	129,00	127,00	136,00	141,00	132,00	141,00	150,00	166,00	178,00	153,00	166,00	174,00	172,00	178,00	197,00	176,00	199,00	208,00
RSL	Električni	Standard	163,20	168,80	175,20	174,40	180,80	184,80	178,40	184,80	190,40	202,40	211,20	193,60	202,40	208,80	207,20	211,20	224,80	209,60	226,40	232,80
	Električni	Trend, Colour by You	204,00	211,00	219,00	218,00	226,00	231,00	223,00	231,00	238,00	253,00	264,00	242,00	253,00	261,00	259,00	264,00	281,00	262,00	283,00	291,00
RSL	Električni	Trend, Colour by You	176,80	182,40	188,80	188,00	194,40	198,40	192,00	198,40	204,00	216,00	224,80	207,20	216,00	222,40	220,80	224,80	238,40	223,20	240,00	246,40
	Električni	Trend, Colour by You	221,00	228,00	236,00	235,00	243,00	248,00	240,00	248,00	255,00	270,00	281,00	259,00	270,00	278,00	276,00	281,00	298,00	279,00	300,00	308,00
RSL	Solarni	Standard	163,20	168,80	175,20	174,40	180,80	184,80	178,40	184,80	190,40	202,40	211,20	193,60	202,40	208,80	207,20	211,20	224,80	209,60	226,40	232,80
	Solarni	Trend, Colour by You	204,00	211,00	219,00	218,00	226,00	231,00	223,00	231,00	238,00	253,00	264,00	242,00	253,00	261,00	259,00	264,00	281,00	262,00	283,00	291,00
RSL	Solarni	Trend, Colour by You	176,80	182,40	188,80	188,00	194,40	198,40	192,00	198,40	204,00	216,00	224,80	207,20	216,00	222,40	220,80	224,80	238,40	223,20	240,00	246,40
	Solarni	Trend, Colour by You	221,00	228,00	236,00	235,00	243,00	248,00	240,00	248,00	255,00	270,00	281,00	259,00	270,00	278,00	276,00	281,00	298,00	279,00	300,00	308,00

Unutarnji rolo za zamračenje

DKL	Ručno upravljanje	Standard	75,20	81,60	89,60	88,00	95,20	99,20	92,00	99,20	106,40	119,20	128,80	108,80	119,20	125,60	124,00	128,80	144,00	127,20	145,60	152,80
	Ručno upravljanje	Standard	94,00	102,00	112,00	110,00	119,00	124,00	115,00	124,00	133,00	149,00	161,00	136,00	149,00	157,00	155,00	161,00	180,00	159,00	182,00	191,00
DKY	Ručno upravljanje	Trend, Colour by You, Dječja kolekcija	88,80	95,20	103,20	101,60	108,80	112,80	105,60	112,80	120,00	132,80	142,40	122,40	132,80	139,20	137,60	142,40	157,60	140,80	159,20	166,40
	Ručno upravljanje	Trend, Colour by You, Dječja kolekcija	111,00	119,00	129,00	127,00	136,00	141,00	132,00	141,00	150,00	166,00	178,00	153,00	166,00	174,00	172,00	178,00	197,00	176,00	199,00	208,00
DML*	Ručno upravljanje	Kolekcija Nature	88,80	95,20	103,20	101,60	108,80	112,80	105,60	112,80	120,00	132,80	142,40	122,40	132,80	139,20	137,60	142,40	157,60	140,80	159,20	166,40
	Ručno upravljanje	Kolekcija Nature	111,00	119,00	129,00	127,00	136,00	141,00	132,00	141,00	150,00	166,00	178,00	153,00	166,00	174,00	172,00	178,00	197,00	176,00	199,00	208,00
DML*	Električni	Standard	170,40	176,80	184,80	183,20	190,40	194,40	187,20	194,40	201,60	214,40	224,00	204,00	214,40	220,80	219,20	224,00	239,20	222,40	240,80	248,00
	Električni	Standard	213,00	221,00	231,00	229,00	238,00	243,00	234,00	243,00	252,00	268,00	280,00	255,00	268,00	276,00	274,00	280,00	299,00	278,00	301,00	310,00
DSL*	Električni	Trend, Colour by You	184,00	190,40	198,40	196,80	204,00	208,00	200,80	208,00	215,20	228,00	237,60	217,60	228,00	234,40	232,80	237,60	252,80	236,00	254,40	261,60
	Električni	Trend, Colour by You	230,00	238,00	248,00	246,00	255,00	260,00	251,00	260,00	269,00	285,00	297,00	272,00	285,00	293,00	291,00	297,00	316,00	295,00	318,00	327,00
DSL*	Solarni	Standard	170,40	176,80	184,80	183,20	190,40	194,40	187,20	194,40	201,60	214,40	224,00	204,00	214,40	220,80	219,20	224,00	239,20	222,40	240,80	248,00
	Solarni	Standard	213,00	221,00	231,00	229,00	238,00	243,00	234,00	243,00	252,00	268,00	280,00	255,00	268,00	276,00	274,00	280,00	299,00	278,00	301,00	310,00
DSL*	Solarni	Trend, Colour by You	184,00	190,40	198,40	196,80	204,00	208,00	200,80	208,00	215,20	228,00	237,60	217,60	228,00	234,40	232,80	237,60	252,80	236,00	254,40	261,60
	Solarni	Trend, Colour by You	230,00	238,00	248,00	246,00	255,00	260,00	251,00	260,00	269,00	285,00	297,00	272,00	285,00	293,00	291,00	297,00	316,00	295,00	318,00	327,00

Unutarnji rolo za zamračenje i zasjenjenje

DFD	Ručno upravljanje	Standard	98,40	105,60	116,00	114,40	124,00	128,80	120,00	128,80	137,60	154,40	-	141,60	154,40	164,00	161,60	168,00	187,20	164,80	189,60	198,40
	Ručno upravljanje	Standard	123,00	132,00	145,00	143,00	155,00	161,00	150,00	161,00	172,00	193,00	-	177,00	193,00	205,00	202,00	210,00	234,00	206,00	237,00	248,00
DFD	Ručno upravljanje	Trend, Colour by You, Dječja kolekcija	88,80	95,20	103,20	101,60	108,80	112,80	105,60	112,80	120,00	132,80	142,40	122,40	132,80	139,20	137,60	142,40	157,60	140,80	159,20	166,40</

Za krovne prozore proizvedene od 2014.																							
Šifra prozora	CK02	CK04	CK06	FK04	FK06	FK08	MK04	MK06		MK08	MK10	MK12	PK06	PK08	PK10	SK06	SK08	SK10	UK04	UK08	UK10		
Vanjske rolete	CK02	CK04	CK06	FK04	FK06	FK08	MK04	MK06		MK08	MK10	MK12	PK06	PK08	PK10	SK06	SK08	SK10	UK04	UK08	UK10		
Sjenila i tende s vodilicama	CK02	CK04	CK06	FK04	FK06	FK08	MK04	MK06		MK08	MK10	MK12	PK06	PK08	PK10	SK06	SK08	SK10	UK04	UK08	UK10		
Sjenila i tende s kucicama	CK00	CK00	CK00	FK00	FK00	FK00	MK00	MK00		MK00	MK00	MK12	PK00	PK00	PK00	SK00	SK00	SK00	UK00	UK00	UK00		
Za krovne prozore proizvedene 2003.-2014.																							
Šifra prozora	C02	C04	C06	F04	F06	F08	M04	M06		M08	M10	M12	P06	P08	P10	S06	S08	S10	U04	U08	U10		
Vanjske rolete	CK02	CK04	CK06	FK04	FK06	FK08	MK04	MK06		MK08	MK10	MK12	PK06	PK08	PK10	SK06	SK08	SK10	UK04	UK08	UK10		
Sjenila i tende s vodilicama	C02	C04	C06	F04	F06	F08	M04	M06		M08	M10	M12	P06	P08	P10	S06	S08	S10	U04	U08	U10		
Sjenila i tende s kucicama	CK00	CK00	CK00	FK00	FK00	FK00	MK00	MK00		MK00	MK00	MK12	PK00	PK00	PK00	SK00	SK00	SK10	UK00	UK00	UK00		
Za krovne prozore proizvedene 1992.-2003.																							
Šifra prozora	102	104	-	204	206	-	304	306		308	310	-	406	408	410	606	608	610	804	808	810		
Vanjske rolete	CK02	CK04	-	FK04	FK06	-	MK04	MK06		MK08	MK10	-	PK06	PK08	PK10	SK06	SK08	SK10	UK04	UK08	UK10		
Sjenila i tende s vodilicama	102	104	-	204	206	-	M04	M06		M08	M10	-	P06	P08	P10	S06	S08	S10	U04	U08	U10		
Sjenila i tende s kucicama	100	100	-	200	200	-	MK00	MK00		MK00	MK00	-	PK00	PK00	PK00	SK00	SK00	SK00	UK00	UK00	UK00		
Oznaka	Upravljanje	Boja																					
			Dimenzija prozora (cm)																				
			55x78	55x98	55x118	66x98	66x118	66x140	78x98	78x118		78x140	78x160	78x180	94x118	94x140	94x160	114x118	114x140	114x160	134x98	134x140	134x160
Cijena bez PDV-a (€)			CK02	CK04	CK06	FK04	FK06	FK08	MK04	MK06		MK08	MK10	MK12	PK06	PK08	PK10	SK06	SK08	SK10	UK04	UK08	UK10
Cijena s PDV-om (€)			CK02	CK04	CK06	FK04	FK06	FK08	MK04	MK06		MK08	MK10	MK12	PK06	PK08	PK10	SK06	SK08	SK10	UK04	UK08	UK10
Plisirano sjenilo																							
FHL	Ručno upravljanje	Standard	98,40	105,60	116,00	114,40	124,00	128,80	120,00	128,80		137,60	154,40	168,00	141,60	154,40	164,00	161,60	168,00	187,20	164,80	189,60	198,40
			<b>123,00</b>	<b>132,00</b>	<b>145,00</b>	<b>143,00</b>	<b>155,00</b>	<b>161,00</b>	<b>150,00</b>	<b>161,00</b>		<b>172,00</b>	<b>193,00</b>	<b>210,00</b>	<b>177,00</b>	<b>193,00</b>	<b>205,00</b>	<b>202,00</b>	<b>210,00</b>	<b>234,00</b>	<b>206,00</b>	<b>237,00</b>	<b>248,00</b>
FHL	Ručno upravljanje	Trend	112,00	119,20	129,60	128,00	137,60	142,40	133,60	142,40		151,20	168,00	181,60	155,20	168,00	177,60	175,20	181,60	200,80	178,40	203,20	212,00
			<b>140,00</b>	<b>149,00</b>	<b>162,00</b>	<b>160,00</b>	<b>172,00</b>	<b>178,00</b>	<b>167,00</b>	<b>178,00</b>		<b>189,00</b>	<b>210,00</b>	<b>227,00</b>	<b>194,00</b>	<b>210,00</b>	<b>222,00</b>	<b>219,00</b>	<b>227,00</b>	<b>251,00</b>	<b>223,00</b>	<b>254,00</b>	<b>265,00</b>
FML	Električni	Standard	193,60	200,80	211,20	209,60	219,20	224,00	215,20	224,00		232,80	249,60	263,20	236,80	249,60	259,20	256,80	263,20	282,40	260,00	284,80	293,60
			<b>242,00</b>	<b>251,00</b>	<b>264,00</b>	<b>262,00</b>	<b>274,00</b>	<b>280,00</b>	<b>269,00</b>	<b>280,00</b>		<b>291,00</b>	<b>312,00</b>	<b>329,00</b>	<b>296,00</b>	<b>312,00</b>	<b>324,00</b>	<b>321,00</b>	<b>329,00</b>	<b>353,00</b>	<b>325,00</b>	<b>356,00</b>	<b>367,00</b>
FML	Električni	Trend	207,20	214,40	224,80	223,20	232,80	237,60	228,80	237,60		246,40	263,20	276,80	250,40	263,20	272,80	270,40	276,80	296,00	273,60	298,40	307,20
			<b>259,00</b>	<b>268,00</b>	<b>281,00</b>	<b>279,00</b>	<b>291,00</b>	<b>297,00</b>	<b>286,00</b>	<b>297,00</b>		<b>308,00</b>	<b>329,00</b>	<b>346,00</b>	<b>313,00</b>	<b>329,00</b>	<b>341,00</b>	<b>338,00</b>	<b>346,00</b>	<b>370,00</b>	<b>342,00</b>	<b>373,00</b>	<b>384,00</b>
FSL	Solarni	Standard	193,60	200,80	211,20	209,60	219,20	224,00	215,20	224,00		232,80	249,60	263,20	236,80	249,60	259,20	256,80	263,20	282,40	260,00	284,80	293,60
			<b>242,00</b>	<b>251,00</b>	<b>264,00</b>	<b>262,00</b>	<b>274,00</b>	<b>280,00</b>	<b>269,00</b>	<b>280,00</b>		<b>291,00</b>	<b>312,00</b>	<b>329,00</b>	<b>296,00</b>	<b>312,00</b>	<b>324,00</b>	<b>321,00</b>	<b>329,00</b>	<b>353,00</b>	<b>325,00</b>	<b>356,00</b>	<b>367,00</b>
FSL	Solarni	Trend	207,20	214,40	224,80	223,20	232,80	237,60	228,80	237,60		246,40	263,20	276,80	250,40	263,20	272,80	270,40	276,80	296,00	273,60	298,40	307,20
			<b>259,00</b>	<b>268,00</b>	<b>281,00</b>	<b>279,00</b>	<b>291,00</b>	<b>297,00</b>	<b>286,00</b>	<b>297,00</b>		<b>308,00</b>	<b>329,00</b>	<b>346,00</b>	<b>313,00</b>	<b>329,00</b>	<b>341,00</b>	<b>338,00</b>	<b>346,00</b>	<b>370,00</b>	<b>342,00</b>	<b>373,00</b>	<b>384,00</b>
Energetsko sjenilo za zamračenje																							
FHC	Ručno upravljanje	Standard	98,40	105,60	116,00	114,40	124,00	128,80	120,00	128,80		137,60	154,40	168,00	141,60	154,40	164,00	161,60	168,00	187,20	164,80	189,60	198,40
			<b>123,00</b>	<b>132,00</b>	<b>145,00</b>	<b>143,00</b>	<b>155,00</b>	<b>161,00</b>	<b>150,00</b>	<b>161,00</b>		<b>172,00</b>	<b>193,00</b>	<b>210,00</b>	<b>177,00</b>	<b>193,00</b>	<b>205,00</b>	<b>202,00</b>	<b>210,00</b>	<b>234,00</b>	<b>206,00</b>	<b>237,00</b>	<b>248,00</b>
FHC	Ručno upravljanje	Trend	112,00	119,20	129,60	128,00	137,60	142,40	133,60	142,40		151,20	168,00	181,60	155,20	168,00	177,60	175,20	181,60	200,80	178,40	203,20	212,00
			<b>140,00</b>	<b>149,00</b>	<b>162,00</b>	<b>160,00</b>	<b>172,00</b>	<b>178,00</b>	<b>167,00</b>	<b>178,00</b>		<b>189,00</b>	<b>210,00</b>	<b>227,00</b>	<b>194,00</b>	<b>210,00</b>	<b>222,00</b>	<b>219,00</b>	<b>227,00</b>	<b>251,00</b>	<b>223,00</b>	<b>254,00</b>	<b>265,00</b>
FMC	Električni	Standard	193,60	200,80	211,20	209,60	219,20	224,00	215,20	224,00		232,80	249,60	263,20	236,80	249,60	259,20	256,80	263,20	282,40	260,00	284,80	293,60
			<b>242,00</b>	<b>251,00</b>	<b>264,00</b>	<b>262,00</b>	<b>274,00</b>	<b>280,00</b>	<b>269,00</b>	<b>280,00</b>		<b>291,00</b>	<b>312,00</b>	<b>329,00</b>	<b>296,00</b>	<b>312,00</b>	<b>324,00</b>	<b>321,00</b>	<b>329,00</b>	<b>353,00</b>	<b>325,00</b>	<b>356,00</b>	<b>367,00</b>
FMC	Električni	Trend	207,20	214,40	224,80	223,20	232,80	237,60	228,80	237,60		246,40	263,20	276,80	250,40	263,20	272,80	270,40	276,80	296,00	273,60	298,40	307,20
			<b>259,00</b>	<b>268,00</b>	<b>281,00</b>	<b>279,00</b>	<b>291,00</b>	<b>297,00</b>	<b>286,00</b>	<b>297,00</b>		<b>308,00</b>	<b>329,00</b>	<b>346,00</b>	<b>313,00</b>	<b>329,00</b>	<b>341,00</b>	<b>338,00</b>	<b>346,00</b>	<b>370,00</b>	<b>342,00</b>	<b>373,00</b>	<b>384,00</b>
FSC	Solarni	Standard	193,60	200,80	211,20	209,60	219,20	224,00	215,20	224,00		232,80	249,60	263,20	236,80	249,60	259,20	256,80	263,20	282,40	260,00	284,80	293,60
			<b>242,00</b>	<b>251,00</b>	<b>264,00</b>	<b>262,00</b>	<b>274,00</b>	<b>280,00</b>	<b>269,00</b>	<b>280,00</b>		<b>291,00</b>	<b>312,00</b>	<b>329,00</b>	<b>296,00</b>	<b>312,00</b>	<b>324,00</b>	<b>321,00</b>	<b>329,00</b>	<b>353,00</b>	<b>325,00</b>	<b>356,00</b>	<b>367,00</b>
FSC	Solarni	Trend	207,20	214,40	224,80	223,20	232,80	237,60	228,80	237,60		246,40	263,20	276,80	250,40	263,20	272,80	270,40	276,80	296,00	273,60	298,40	307,20
			<b>259,00</b>	<b>268,00</b>	<b>281,00</b>	<b>279,00</b>	<b>291,00</b>	<b>297,00</b>	<b>286,00</b>	<b>297,00</b>		<b>308,00</b>	<b>329,00</b>	<b>346,00</b>	<b>313,00</b>	<b>329,00</b>	<b>341,00</b>	<b>338,00</b>	<b>346,00</b>	<b>370,00</b>	<b>342,00</b>	<b>373,00</b>	<b>384,00</b>
Unutarnja žaluzina																							
PAL	Ručno upravljanje	Standard	98,40	105,60	116,00	114,40	124,00	128,80	120,00	128,80		137,60	154,40	168,00	141,60	154,40	164,00	161,60	168,00	187,20	164,80	189,60	198,40
			<b>123,00</b>	<b>132,00</b>	<b>145,00</b>	<b>143,00</b>	<b>155,00</b>	<b>161,00</b>	<b>150,00</b>	<b>161,00</b>		<b>172,00</b>	<b>193,00</b>	<b>210,00</b>	<b>177,00</b>	<b>193,00</b>	<b>205,00</b>	<b>202,00</b>	<b>210,00</b>	<b>234,00</b>	<b>206,00</b>	<b>237,00</b>	<b>248,00</b>
Rolo sjenilo za zamračenje Classic za prozore proizvedene između 2000. i 2012. godine																							
DBL	Ručno upravljanje	Standard	52,80	56,80	-	61,60	66,40	-	64,80	69,60		74,40	83,20	-	76,00	83,20	-	87,20	90,40	-	88,80	102,40	-
			<b>66,00</b>	<b>71,00</b>		<b>77,00</b>	<b>83,00</b>		<b>81,00</b>	<b>87,00</b>		<b>93,00</b>	<b>104,00</b>		<b>95,00</b>	<b>104,00</b>		<b>109,00</b>	<b>113,00</b>		<b>111,00</b>	<b>128,00</b>	

Bočne vodilice kod unutarnjih rolo sjenila mogu se naručiti u bijeloj boji ili boji aluminij.  
 Prilikom naručivanja potrebno je uvijek navesti vrstu bočnih vodilica (ne odnosi se na sjenila RHZ, RHL).  
 Primjer: DKL MK06 1025S – boja aluminija  
 DKL MK06 1025SWL – bijela boja

Dodatnu opremu uvijek naručite prema identifikacijskoj pločici na krovnom prozoru. Osim toga, šifra dimenzije trenutne generacije krovnog prozora sadrži slovo K, npr. MK06, šifra dimenzije prethodne generacije iste veličine ima šifru bez slova K, npr. M06.  
 Za narudžbu unutarnjih sjenila i vanjskih roleta za krovne prozore kupljene prije 2002. godine obratite se VELUX službi za korisnike.

Cijena bez PDV-a (€)  
Cijena s PDV-om (€)

Šifra dimenzije  
Dimenzija okvira u cm

CK02 55x78	CK04 55x98	CK06 55x118	FK04 66x98	FK06 66x118	FK08 66x140	MK04 78x98	MK06 78x118	MK08 78x140	MK10 78x160	PK06 94x118	PK08 94x140	PK10 94x160	SK06 114x118	SK08 114x140	UK08 134x140
---------------	---------------	----------------	---------------	----------------	----------------	---------------	----------------	----------------	----------------	----------------	----------------	----------------	-----------------	-----------------	-----------------

**SETOVI ZA KONTROLU SVJETLOSTI I VRUĆINE**

**ROLO SJENILO ZA ZASJENJENJE + VANJSKA TENDA**

**KUPITE SET I OSTVARITE 10 % POPUSTA**

ROP	RHL + MHL	Standard	81,36 101,70	94,32 117,90	100,80 126,00	100,80 126,00	117,36 146,70	130,32 162,90	141,84 177,30
-----	-----------	----------	-----------------	-----------------	------------------	------------------	------------------	------------------	------------------

**ROLO SJENILO ZA ZASJENJENJE + VANJSKA TENDA**

**KUPITE SET I OSTVARITE 10 % POPUSTA**

ROF	RFL + MHL	Standard	106,56 133,20	111,60 139,50	117,36 146,70	123,84 154,80	129,60 162,00	133,20 166,50	131,04 163,80	136,80 171,00	141,84 177,30	152,64 190,80	154,08 192,60	162,00 202,50	167,76 209,70	173,52 216,90	177,12 221,40	197,28 246,60
-----	-----------	----------	------------------	------------------	------------------	------------------	------------------	------------------	------------------	------------------	------------------	------------------	------------------	------------------	------------------	------------------	------------------	------------------

**ROLO SJENILO ZA ZAMRAČENJE + VANJSKA TENDA**

**KUPITE SET I OSTVARITE 10 % POPUSTA**

DOP	DKL + MHL	Standard	113,04 141,30	118,80 148,50	126,00 157,50	131,76 164,70	138,24 172,80	141,84 177,30	138,96 173,70	145,44 181,80	151,92 189,90	163,44 204,30	163,44 204,30	172,80 216,00	178,56 223,20	184,32 230,40	188,64 235,80	210,24 262,80
-----	-----------	----------	------------------	------------------	------------------	------------------	------------------	------------------	------------------	------------------	------------------	------------------	------------------	------------------	------------------	------------------	------------------	------------------

**ENERGETSKO PLISIRANO SJENILO ZA ZAMRAČENJE + VANJSKA TENDA**

**KUPITE SET I OSTVARITE 10 % POPUSTA**

FOP	FHC + MHL	Standard	133,92 167,40	140,40 175,50	149,76 187,20	155,52 194,40	164,16 205,20	168,48 210,60	164,16 205,20	172,08 215,10	180,00 225,00	195,12 243,90	192,96 241,20	204,48 255,60	213,12 266,40	218,16 272,70	223,92 279,90	249,84 312,30
-----	-----------	----------	------------------	------------------	------------------	------------------	------------------	------------------	------------------	------------------	------------------	------------------	------------------	------------------	------------------	------------------	------------------	------------------

DOP/FOP set se može naručiti sa bočnim vodilicama u bijeloj boji ili boji aluminijska. Prilikom naručivanja potrebno je uvijek navesti vrstu bočnih vodilica.

\* Energetsko sjenilo za zamračenje (FHC) s bijelim bočnim vodilicama ne uključuje paket nosača za sjenilo na krovne prozore prethodnih generacija.

U slučaju oštećenja ili nedostatka nosača za sjenila na krovnom prozoru potrebno je kupiti set ZOZ 230.



**RFL/RML/RSL/RHL\***

Kolekcija Standard



Kolekcija Trend



**DKL/DML/DSL/DFD**

Kolekcija Standard

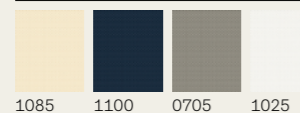

Kolekcija Trend

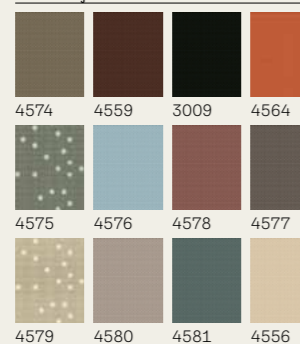

**DKL/DFD**

Dječja kolekcija



**FHC/FMC/FSC**

Kolekcija Standard

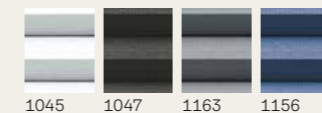

Kolekcija Trend



**FHL/FML/FSL**

Kolekcija Standard

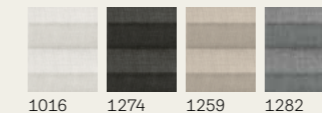

Kolekcija Trend



**PAL**

Kolekcija Standard

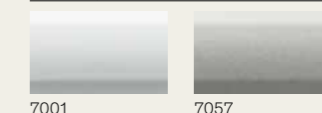

\* RHL samo u kolekciji Standard.

**RFY**

Kolekcija Nature

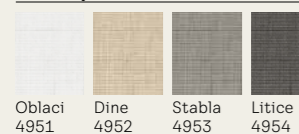

**DKY**

Kolekcija Nature

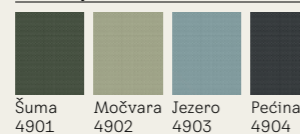

**DKL/DML/DSL/RFL/RML/RSL**

Colour By You kolekcija

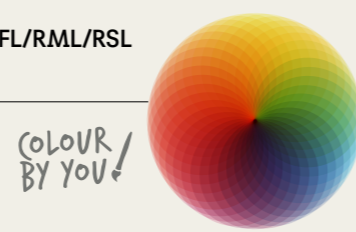

## KOMARNIK

Cijena bez PDV-a (€)  
Cijena s PDV-om (€)

**A**

	0-438 mm	439-530 mm	531-640 mm	641-760 mm	761-922 mm	923-1120 mm	1121-1285 mm
<b>B</b> 0-1600 mm	ZIL BK04	ZIL CK02	ZIL FK08	ZIL MK06	ZIL PK25	ZIL SK06	ZIL UK04
	113,60 <b>142,00</b>	105,60 <b>132,00</b>	139,20 <b>174,00</b>	139,20 <b>174,00</b>	152,80 <b>191,00</b>	173,60 <b>217,00</b>	177,60 <b>222,00</b>
<b>B</b> 1601-2000 mm		ZIL CK06	ZIL FK08	ZIL MK06	ZIL PK06	ZIL SK06	ZIL UK10
		124,80 <b>156,00</b>	139,20 <b>174,00</b>	139,20 <b>174,00</b>	152,80 <b>191,00</b>	173,60 <b>217,00</b>	213,60 <b>267,00</b>
<b>B</b> 2001-2400 mm			ZIL FK08	ZIL MK10	ZIL PK10	ZIL SK10	ZIL UK10
			139,20 <b>174,00</b>	166,40 <b>208,00</b>	176,00 <b>220,00</b>	201,60 <b>252,00</b>	213,60 <b>267,00</b>

Komarnici su kompatibilni s prethodnom i sadašnjom generacijom VELUX krovnih prozora. Šifre dimenzije komarnika se mogu razlikovati od šifre dimenzije prozora pa izmjerite (A) i (B) i pronađite ispravnu šifru dimenzije prije naručivanja.

### Kako naručiti pravu dimenziju:

Izmjerite širinu (A) i visinu (B) unutarnje obloge oko krovnog prozora kako biste odredili odgovarajuću dimenziju komarnika.

Ukoliko imate dvostruku visinu (B) ili visinu iznad 2400 mm trebat ćete dva komarnika i jedan set za spajanje ZOZ 157 SWL.

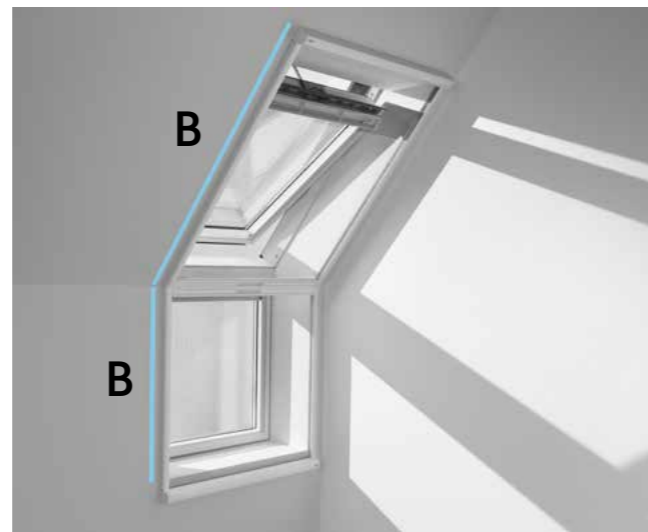
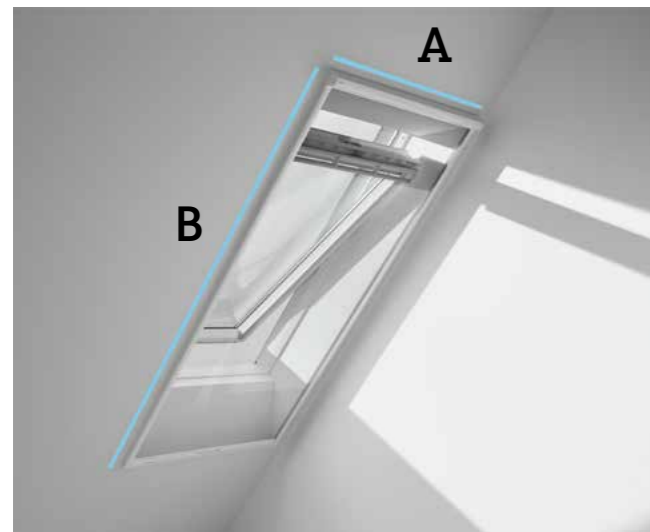

Za krovne prozore proizvedene od 2014.																						
Šifra prozora	CK02	CK04	CK06	FK04	FK06	FK08	MK04	MK06		MK08	MK10	MK12	PK06	PK08	PK10	SK06	SK08	SK10	UK04	UK08	UK10	
Vanjske rolete	CK02	CK04	CK06	FK04	FK06	FK08	MK04	MK06		MK08	MK10	MK12	PK06	PK08	PK10	SK06	SK08	SK10	UK04	UK08	UK10	
Sjenila i tende s vodilicama	CK02	CK04	CK06	FK04	FK06	FK08	MK04	MK06		MK08	MK10	MK12	PK06	PK08	PK10	SK06	SK08	SK10	UK04	UK08	UK10	
Sjenila i tende s kucicama	CK00	CK00	CK00	FK00	FK00	FK00	MK00	MK00		MK00	MK00	MK12	PK00	PK00	PK00	SK00	SK00	SK00	UK00	UK00	UK00	
Za krovne prozore proizvedene 2003.-2014.																						
Šifra prozora	C02	C04	C06	F04	F06	F08	M04	M06		M08	M10	M12	P06	P08	P10	S06	S08	S10	U04	U08	U10	
Vanjske rolete	CK02	CK04	CK06	FK04	FK06	FK08	MK04	MK06		MK08	MK10	MK12	PK06	PK08	PK10	SK06	SK08	SK10	UK04	UK08	UK10	
Sjenila i tende s vodilicama	C02	C04	C06	F04	F06	F08	M04	M06		M08	M10	M12	P06	P08	P10	S06	S08	S10	U04	U08	U10	
Sjenila i tende s kucicama	CK00	CK00	CK00	FK00	FK00	FK00	MK00	MK00		MK00	MK00	MK12	PK00	PK00	PK00	SK00	SK00	SK10	UK00	UK00	UK00	
Za krovne prozore proizvedene 1992.-2003.																						
Šifra prozora	102	104	-	204	206	-	304	306		308	310	-	406	408	410	606	608	610	804	808	810	
Vanjske rolete	CK02	CK04	-	FK04	FK06	-	MK04	MK06		MK08	MK10	-	PK06	PK08	PK10	SK06	SK08	SK10	UK04	UK08	UK10	
Sjenila i tende s vodilicama	102	104	-	204	206	-	M04	M06		M08	M10	-	P06	P08	P10	S06	S08	S10	U04	U08	U10	
Sjenila i tende s kucicama	100	100	-	200	200	-	MK00	MK00		MK00	MK00	-	PK00	PK00	PK00	SK00	SK00	SK00	UK00	UK00	UK00	
Oznaka	Upravljanje	Boja																				
		Dimenzija prozora (cm)																				
		55x78	55x98	55x118	66x98	66x118	66x140	78x98	78x118		78x140	78x160	78x180	94x118	94x140	94x160	114x118	114x140	114x160	134x98	134x140	134x160
Cijena bez PDV-a (€)		CK02	CK04	CK06	FK04	FK06	FK08	MK04	MK06		MK08	MK10	MK12	PK06	PK08	PK10	SK06	SK08	SK10	UK04	UK08	UK10
Cijena s PDV-om (€)		CK02	CK04	CK06	FK04	FK06	FK08	MK04	MK06		MK08	MK10	MK12	PK06	PK08	PK10	SK06	SK08	SK10	UK04	UK08	UK10

## VANJSKA ZAŠTITA OD VRUĆINE LJETI I TOPLINSKA ZAŠTITA ZIMI

Vanjske rolete ALU																								
SML	Električni	VELUX električna vanjska roleta SML	0000	350,40 438,00	372,00 465,00	384,00 480,00	384,00 480,00	400,80 501,00	417,60 522,00	396,80 496,00	417,60 522,00		438,40 548,00	459,20 574,00	522,40 653,00	451,20 564,00	476,00 595,00	500,80 626,00	484,80 606,00	517,60 647,00	543,20 679,00	480,00 600,00	559,20 699,00	601,60 752,00
SSL	Solarni	VELUX solarna vanjska roleta SSL	0000	491,20 614,00	520,00 650,00	537,60 672,00	537,60 672,00	561,60 702,00	584,80 731,00	555,20 694,00	584,80 731,00		613,60 767,00	643,20 804,00	731,20 914,00	631,20 789,00	666,40 833,00	701,60 877,00	678,40 848,00	724,80 906,00	760,00 950,00	672,00 840,00	783,20 979,00	841,60 1.052,00
SMG	Električni	VELUX električne vanjske rolete SMG za VELUX krovni prozor u kombinaciji s VELUX prozorskim elementima GIL/GIU	0000	-	-	-	845,60 1.057,00	881,60 1.102,00	918,40 1.148,00	872,80 1.091,00	918,40 1.148,00		964,80 1.206,00	1.010,40 1.263,00	-	992,00 1.240,00	1.047,20 1.309,00	1.102,40 1.378,00	1.065,60 1.332,00	1.139,20 1.424,00	1.194,40 1.493,00	1.056,80 1.321,00	1.231,20 1.539,00	1.323,20 1.654,00
SMH	Električni	VELUX električna vanjska roleta SMH	0000	-	-	-	-	561,60 702,00	584,80 731,00	-	584,80 731,00		613,60 767,00	-	-	631,20 789,00	666,40 833,00	-	678,40 848,00	724,80 906,00	-	-	-	-
Vanjske rolete SOFT																								
SSS	Solarni	VELUX solarna vanjska roleta SOFT SSS	0000	263,20 329,00	278,40 348,00	288,00 360,00	288,00 360,00	300,80 376,00	313,60 392,00	297,60 372,00	313,60 392,00		328,80 411,00	344,80 431,00	391,20 489,00	338,40 423,00	356,80 446,00	376,00 470,00	363,20 454,00	388,00 485,00	407,20 509,00	360,00 450,00	420,00 525,00	451,20 564,00
Vanjska tenda, ručno upravljanje																								
MHL	Ručno upravljanje	VELUX vanjska tenda MHL	5060		50,40 63,00				58,40 73,00		62,40 78,00		62,40 78,00	78,40 98,00		72,80 91,00			80,80 101,00				88,00 110,00	
MIE	Ručno upravljanje	VELUX vanjska tenda MIE za vertikalni element VFE	5060		-				-		104,80 131,00		104,80 131,00	-		120,80 151,00			134,40 168,00				146,40 183,00	
Vanjska tenda, daljinsko upravljanje																								
MML	Električni	VELUX električna vanjska tenda MML	5060	210,40 263,00	223,20 279,00	230,40 288,00	230,40 288,00	240,80 301,00	250,40 313,00	238,40 298,00	250,40 313,00		263,20 329,00	276,00 345,00	313,60 392,00	270,40 338,00	285,60 357,00	300,80 376,00	290,40 363,00	310,40 388,00	325,60 407,00	288,00 360,00	336,00 420,00	360,80 451,00
MSL	Solarni	VELUX solarna vanjska tenda MSL	5060	263,20 329,00	278,40 348,00	288,00 360,00	288,00 360,00	300,80 376,00	313,60 392,00	297,60 372,00	313,60 392,00		328,80 411,00	344,80 431,00	391,20 489,00	338,40 423,00	356,80 446,00	376,00 470,00	363,20 454,00	388,00 485,00	407,20 509,00	360,00 450,00	420,00 525,00	451,20 564,00

VELUX unutarnja sjenila i vanjske rolete kompatibilne su s prethodnim i sadašnjom generacijama VELUX krovnih prozora. Uvijek naručite dodatnu opremu prema prozoru s numeričkom krovnom šifrom.

Dodatnu opremu uvijek naručite prema identifikacijskoj pločici na krovnom prozoru. Osim toga, šifra dimenzije trenutne generacije krovnog prozora sadrži slovo **K**, npr. MK06, šifra dimenzije prethodne generacije iste veličine ima šifru bez slova **K**, npr. M06. Za narudžbu unutarnjih sjenila i vanjskih roleta za krovne prozore kupijene prije 2002. godine obratite se VELUX službi za korisnike.

VELUX vanjske rolete i električno ili solarno napajane vanjske tende imaju 5 godina jamstva.

MHL vanjska tenda nije kompatibilna s KMG/KSX proizvodima za elektrifikaciju.

Dodaci na daljinsko upravljanje, s električnim napajanjem dizajnirani su za spajanje na GGL/GGU električne krovne prozore ili na KUX 110 jedinicu za napajanje.

MML/MSL vanjske tende za kombinacije prozora mogu se ugrađivati samo na kombinirane opšave s vertikalnim razmakom od 250 mm i horizontalnim razmakom od minimalno 18 mm.

SML/SSL (SMH) vanjske rolete za kombinacije prozora mogu se ugrađivati samo na kombinirane opšave s vertikalnim razmakom od 250 (300) mm i horizontalnim razmakom najmanje 100 mm.

SSS vanjske rolete za kombinacije prozora mogu se ugrađivati samo na kombinirane opšave s vertikalnim razmakom od 250 mm i horizontalnim razmakom najmanje 18 mm.

SST vanjska roleta ALU ugrađuje se na evakuacijske krovne prozore GTU/L. Za kombinaciju fiksnim donjim elementom ugrađuje se vanjska roleta SOFT SSI ili vanjska tenda MSI. Za više informacija obratite se VELUX korisničkoj službi.

Cijena bez PDV-a (€)		Cijena s PDV-om (€)		MK04	PK04	SK04
<b>VANJSKA ZAŠTITA OD VRUĆINE ZA KROVNI BALKON GDL</b>						
MAD	Ručno upravljanje	VELUX vanjska tenda MAD za donji element prozora VELUX krovnog balkona GDL.	5060	99,20 <b>124,00</b>	107,20 <b>134,00</b>	116,00 <b>145,00</b>

MAD vanjska tenda se ugrađuje na donji dio okvira GDL krovnog balkona. Za gornji dio potrebno je kupiti MHL vanjsku tendu.

Cijena bez PDV-a (€)		Cijena s PDV-om (€)		MK34	PK34	SK34	UK34
<b>VANJSKA ZAŠTITA OD VRUĆINE ZA FIKSNE DONJE ELEMENTE GIL/GIU</b>							
MAG	Ručno upravljanje	VELUX vanjska tenda MAG za VELUX prozorske elemente GIL/GIU	5060	96,80 <b>121,00</b>	110,40 <b>138,00</b>	125,60 <b>157,00</b>	133,60 <b>167,00</b>

MAG vanjska tenda se ugrađuje na donji dio okvira GIL/GLU krovnog prozora.

Cijena bez PDV-a (€)		Cijena s PDV-om (€)		CRO0	FRO0	MRO0	PRO0	SRO0	URO0
<b>VANJSKA ZAŠTITA OD VRUĆINE ZA ELEKTRIČNO UPRAVLJANE KROVNE PROZORE</b>									
MIV	Ručno upravljanje	VELUX vanjska tenda MIV	4260	50,40 <b>63,00</b>	58,40 <b>73,00</b>	62,40 <b>78,00</b>	72,80 <b>91,00</b>	80,80 <b>101,00</b>	88,00 <b>110,00</b>

Cijena bez PDV-a (€)		Cijena s PDV-om (€)		FFKF06	FFKF08
<b>VANJSKA ZAŠTITA OD VRUĆINE LJETI I TOPLINSKA ZAŠTITA ZIMI ZA KROVNE PROZORE 3U1</b>					
SSLS	Solarni	VELUX solarna vanjska roleta 3 u 1 SSLS	0000	1.684,80 <b>2.106,00</b>	1.754,40 <b>2.193,00</b>
SSSS	Solarni	VELUX solarna vanjska roleta 3 u 1 SOFT SSSS	0000	1.142,40 <b>1.428,00</b>	1.190,40 <b>1.488,00</b>
MSLS	Solarni	VELUX solarna vanjska tenda 3 u 1 MSLS	5060	902,40 <b>1.128,00</b>	940,80 <b>1.176,00</b>

Cijena bez PDV-a (€)		Cijena s PDV-om (€)		Šifra dimenzije Dimenzija okvira u cm														
				FK04 66x98	FK06 66x118	FK08 66x140	MK04 78x98	MK06 78x118	MK08 78x140	MK10 78x160	PK06 94x118	PK08 94x140	PK10 94x160	SK06 114x118	SK08 114x140	UK08 134x140		

<b>VANJSKA ZAŠTITA OD VRUĆINE U SETOVIMA</b>																
<b>SOLARNA VANJSKA ROLETA ALU + SOLARNI SET KSX 100K (ZA ELEKTRIFIKACIJU PROZORA)</b>																
SSL S30002	SSL 0000 + KSX	0000	758,40 <b>948,00</b>	782,40 <b>978,00</b>	805,60 <b>1.007,00</b>	776,00 <b>970,00</b>	805,60 <b>1.007,00</b>	834,40 <b>1.043,00</b>	864,00 <b>1.080,00</b>	852,00 <b>1.065,00</b>		887,20 <b>1.109,00</b>	922,40 <b>1.153,00</b>	899,20 <b>1.124,00</b>	945,60 <b>1.182,00</b>	1.004,00 <b>1.255,00</b>
<b>SOLARNA VANJSKA ROLETA SOFT + SOLARNI SET KSX 100K (ZA ELEKTRIFIKACIJU PROZORA)</b>																
SSS S30001	SSS 0000 + KSX	0000	508,80 <b>636,00</b>	521,60 <b>652,00</b>	534,40 <b>668,00</b>	518,40 <b>648,00</b>	534,40 <b>668,00</b>	549,60 <b>687,00</b>	565,60 <b>707,00</b>	559,20 <b>699,00</b>		577,60 <b>722,00</b>	596,80 <b>746,00</b>	584,00 <b>730,00</b>	608,80 <b>761,00</b>	640,80 <b>801,00</b>

-90 €

## ELEKTRIČNI PROIZVODI

Cijena bez PDV-a (€)		Cijena s PDV-om (€)	
<b>PROIZVODI ZA PAMETNO UPRAVLJANJE DOMOM</b>			
<b>KMG 100K</b>	VELUX elektromotor KMG 100K	200,80	<b>251,00</b>
<b>KMG 100</b>	VELUX elektromotor KMG 100	200,80	<b>251,00</b>
<b>KSX 100K WW</b>	VELUX set za elektrifikaciju na solarno napajanje KSX 100K	292,80	<b>366,00</b>
<b>KSX 100</b>	VELUX set za elektrifikaciju na solarno napajanje KSX 100	292,80	<b>366,00</b>
<b>KUX 110 EU</b>	VELUX jedinica za napajanje KUX 110	92,00	<b>115,00</b>
<b>KLI 310</b>	VELUX električni zidni prekidač KLI 310	26,40	<b>33,00</b>
<b>KLI 311</b>	VELUX električni zidni prekidač KLI 311	26,40	<b>33,00</b>
<b>KLI 312</b>	VELUX električni zidni prekidač KLI 312	26,40	<b>33,00</b>
<b>KLI 313</b>	VELUX električni zidni prekidač KLI 313	26,40	<b>33,00</b>
<b>KLR 300</b>	VELUX Touch	104,80	<b>131,00</b>
<b>KIG 300</b>	Aplikacija za upravljanje VELUX	100,00	<b>125,00</b>
<b>KIX 300</b>	VELUX ACTIVE kontrola unutarnje klime KIX 300	200,00	<b>250,00</b>
<b>KLN 300</b>	VELUX ACTIVE prekidač kod odlaska KLN 300	44,80	<b>56,00</b>
<b>KLF 050</b>	VELUX električni interface prekidača KLF 050	49,60	<b>62,00</b>
<b>KLB 100</b>	VELUX električna pričuva na baterija KLB 100	238,40	<b>298,00</b>

Za elektrifikaciju ručno upravljanih VELUX krovnih prozora trenutne generacije, potreban je elektromotor KMG 100K + jedinica za napajanje KUX 110 EU ili solarni set za naknadnu elektrifikaciju KSX 100K.

Elektromotor KMG i KSX također uključuju VELUX zidni prekidač za prozore KLI. Setovi za naknadnu elektrifikaciju nisu kompatibilni s dimenzijom CK02 i manjim.

Kod ugradnje električnih sjenila DML/FMC/RML/FML na ručno upravljani VELUX krovni prozor ili prozore s KMG elektromotorom, potrebno je kupiti set kablova – ZOZ 241 za trenutne modele prozora ili ZOZ 243 za prozore proizvedene prije 2001. godine. Odaberite vrstu adaptera prema generaciji VELUX krovnog prozora.

VELUX sučelje za električne prozore KLF 200 omogućuje povezivanje s vanjskim sustavom i upravljanje do 200 motoriziranih proizvoda raspoređenih u maksimalno 5 grupa.

## DODATNA OPREMA

Cijena bez PDV-a (€)		Cijena s PDV-om (€)	
<b>DODATNA OPREMA ZA KROVNE PROZORE</b>			
Dodana oprema za upravljanje i sigurnost			
<b>ZCZ 112</b>	Upravljačka šipka idealna je za upravljanje VELUX krovnim prozorima s donjim upravljanjem, koji se postavljaju na nedostupnim mjestima. Upravljačka šipka dugačka je 120 cm.	31,20	<b>39,00</b>
<b>ZOZ 012K1</b>	Povećajte svoju zaštitu dodavanjem protuprovalne brave na svoje krovne prozore sa središnjim ovjesom. Sprječava otvaranje prozora iznutra bez ključa.	32,80	<b>41,00</b>
<b>ZOZ 095</b>	Ovaj adapter idealan je za ručne krovne prozore sa središnjim ovjesom (GLU, GLL, GZL) koji se postavljaju na nedostupnim mjestima. Ako svojim prozorom želite upravljati teleskopskim štapićem, jednostavno pričvrstite ovaj adapter na aluminijsku ručku.	10,40	<b>13,00</b>
<b>ZZZ 181K2</b>	Donja ručka, koja se može montirati na VELUX krovne prozore sa središnjim ovjesom sa slovom „K“ u šifri veličine, za omogućivanje otvaranja s pomoću donjeg upravljanja.	32,80	<b>41,00</b>
<b>ZZZ 237</b>	Za jednostavno, brzo i sigurno podizanje teških krovnih prozora pričvrstite transportne kuke na obje strane VELUX krovnog prozora. Kada su pričvršćene, transportne trake za podizanje mogu se spojiti te se prozor može brzo i jednostavno podići na krovni otvor. Transportne kuke mogu se upotrebljavati s većinom tipova VELUX krovnih prozora do 120 kg.	424,00	<b>530,00</b>
<b>ZZZ 244</b>	Uz upotrebu fleksibilnih traka za nošenje, dvije osobe mogu sigurno nositi velike i teške VELUX kutije na krov bez dodatne opreme. Trake se mogu upotrebljavati sa svim VELUX krovnim prozorima za praktično podizanje i precizno manevriranje kroz uske prolaze i stubišta.	68,00	<b>85,00</b>
<b>ZZZ 258</b>	VELUX višekratne zaštite okvira dizajnirane su za smanjenje rizika od oštećenja prilikom ponovnog postavljanja prozora u okvir prozora. Napravljen od izdržljive gume, set od tri zaštite može se postaviti na donji i bočni okvir bilo kojeg VELUX krovnog prozora kako bi se spriječilo ostavljanje tragova na okviru.	28,00	<b>35,00</b>

Cijena bez PDV-a (€)		Cijena s PDV-om (€)	
<b>DODATNA OPREMA ZA SJENILA I ROLETE</b>			
<b>ZCT 100</b>	Produžetak za teleskopsku upravljačku šipku ZCT 200K, koji dodaje 100 cm teleskopskoj upravljačkoj šipci dugoj 180 cm.	12,00	<b>15,00</b>
<b>ZCT 200K</b>	Teleskopska šipka od 100 do 180 cm omogućuje upravljanje VELUX ručno upravljanim krovnim prozorima sa središnjim ovjesom, unutarnjim sjenilima i komarnicima postavljenim van dohvata.	23,20	<b>29,00</b>
<b>ZCZ 080K</b>	Ručna upravljačka šipka za upravljanje VELUX krovnim prozorima sa središnjim ovjesom GGL/GGU postavljenim na teško dostupnim mjestima. Može upotrebljavati i za upravljanje VELUX sjenilima, ali tada preporučujemo da na svako sjenilo pričvrstite adapter (ZOZ 085). Šipka je dugačka 80 cm.	16,80	<b>21,00</b>
<b>ZOZ 040</b>	Adapter za unutarnja sjenila koji omogućuje upravljanje sjenilom sa ZCT šipkom. Pogodno za unutarnje rolole s kukama.	8,00	<b>10,00</b>
<b>ZOZ 085</b>	Adapter za unutarnja sjenila koji omogućuje upravljanje sjenilom sa ZCT šipkom.	8,00	<b>10,00</b>
<b>ZOZ 157SWL</b>	Za visinu unutarnjeg zida preko 2400 mm ili za nadozidne prozore s dvije visine potrebna su dva komarnika i jedan komplet priključaka ZOZ 157SWL.	23,20	<b>29,00</b>
<b>ZOZ ++</b>	Adapter za proizvode za vanjsku zaštitu od sunca koji omogućuje upravljanje proizvodom za zaštitu od sunca na solarnim krovnim prozorima GGL i GGU.	52,80	<b>66,00</b>
<b>ZOZ 217</b>	Mehanizmi za fiksiranje služe za dodatnu ventilaciju i dotok svjetla kada je vanjska roleta spuštena. Samo za ručne VELUX krovne prozore od 2000. (ne za GTU/GTL).	53,60	<b>67,00</b>
<b>ZOZ 229</b>	Posebni nosači koji omogućuju ugradnju vanjskih tendi MML-SA i MSL-SA na VELUX GPU električni prozor.	60,00	<b>75,00</b>
<b>ZOZ 230</b>	Potrebni nosači za montažu sjenila za prozore proizvedene prije 2012.	4,00	<b>5,00</b>
<b>ZOZ 238</b>	ZOZ 238 je set za ugradnju vanjske zaštite od sunca SSS-SA, MSL-SA, MML-SA na VELUX krovnim prozorima proizvedenim prije 2000. godine. ZOZ 238 ne može se upotrebljavati na VELUX krovnim prozorima proizvedenim prije 1992. godine.	17,60	<b>22,00</b>
<b>ZOZ 241</b>	Komplet kabela neophodan je za ugradnju VELUX električnih sjenila na VELUX krovne prozore s ručnim upravljanjem ili na VELUX krovne prozore s ručnim upravljanjem, koji su nadograđeni motorom. VELUX električnim sjenilima može se daljinski upravljati, što vam pruža potpunu kontrolu nad prirodnim svjetlom u sobi.	17,60	<b>22,00</b>
<b>ZOZ 243</b>	Set kabela potreban je za VELUX električna sjenila koja se postavljaju na starije generacije VELUX krovnih prozora (VKI/VES/V21).	17,60	<b>22,00</b>
<b>ZOZ 246</b>	Upotrebljava se kod postavljanja roleta sa solarnim napajanjem i vanjskih tendi (SSS ili MSL) na male VELUX solarne krovne prozore (veličine C i F).	40,00	<b>50,00</b>
<b>ZOZ 250</b>	Žica koja se koristi za punjenje solarnu vanjske tende i vanjske rolete SOFT (MSL/SSS) na demo štandovima	9,60	<b>12,00</b>
<b>ZOZ 253</b>	Set za ugradnju za montažu vanjskih roleta SML/SSL na krovne prozore proizvedene prije 2000. godine	17,60	<b>22,00</b>
<b>ZOZ 254</b>	Set za ugradnju za SSL/SML za ugradnju vanjskih roleta SSL/SML na krovnim prozorima proizvedenim od 1942. do 2000. godine	17,60	<b>22,00</b>

Kod ugradnje električnih sjenila DML/FMC/RML/FML na ručno upravljani VELUX krovni prozor ili prozore s KMG elektromotorom, potrebno je kupiti set kablova – ZOZ 241 za trenutne modele prozora ili ZOZ 243 za prozore proizvedene prije 2001. godine.



## IZLAZI ZA KROV



Cijena bez PDV-a (€)  
Cijena s PDV-om (€)

CK06 55x118	FK06 66x118	MK04 78x98

### PROZORI ZA IZLAZ NA KROV

		W/(m <sup>2</sup> K)	Nagib krova			
<b>GXL 3070</b>	Ručno upravljanje, borovo drvo, završno premazano u tri sloja, prozirni lak, dvostruko staklo	1.3	15-85	-	512,00 <b>640,00</b>	501,60 <b>627,00</b>
<b>GXL 3068</b>	Ručno upravljanje, borovo drvo, završno premazano u tri sloja, prozirni lak, trostruko staklo	1.1	15-85	-	640,00 <b>800,00</b>	-
<b>GXL 3066</b>	Ručno upravljanje, borovo drvo, završno premazano u tri sloja, prozirni lak, trostruko staklo	1.0	15-85	-	716,80 <b>896,00</b>	-
<b>GXU 0070</b>	Ručno upravljanje, bijeli poliuretani oblikovan oko drvene jezgre s dodatnim izdržljivim premazom, dvostruko staklo	1.3	15-85	558,40 <b>698,00</b>	583,20 <b>729,00</b>	-
<b>GXU 0066</b>	Ručno upravljanje, bijeli poliuretani oblikovan oko drvene jezgre s dodatnim izdržljivim premazom, trostruko staklo	1.0	15-85	781,60 <b>977,00</b>	816,80 <b>1.021,00</b>	-
<b>GXL 2070</b>	Ručno upravljanje, borovo drvo, završno premazano u tri sloja, obojeno bijelom bojom, dvostruko staklo	1.3	15-85	-	512,00 <b>640,00</b>	501,60 <b>627,00</b>
<b>GXL 2066</b>	Ručno upravljanje, borovo drvo, završno premazano u tri sloja, obojeno bijelom bojom, trostruko staklo	1.0	15-85	-	716,80 <b>896,00</b>	-

Izlaz na krov GXL/GXU otvara se pomoću ručke u sredini krila. Smjer otvaranja krila može se promijeniti. Prozori GXL/GXU uvijek se otvaraju prema van. Nisu kompatibilni s unutarnjim sjenilima ili vanjskim roletama.

Za više informacija o GXL i GXU s vanjskim profilima od bakra ili titan-cinka, kontaktirajte VELUX službu za korisnike.

Opšavi su potrebni za ugradnju.



Cijena bez PDV-a (€)  
Cijena s PDV-om (€)

MK08 78x140	SK08 114x140	SK10 114x160

### PROZORI ZA EVAKUACIJU

		W/(m <sup>2</sup> K)	Nagib krova			
<b>GTL 3070</b>	Ručno upravljanje, s donjom ručkom i dvostrukim ovjesom, borovo drvo, završno premazano u tri sloja, prozirni lak, dvostruko staklo	1.3	15-55	722,40 <b>903,00</b>	924,80 <b>1.156,00</b>	-
<b>GTL 3066</b>	Ručno upravljanje, s donjom ručkom i dvostrukim ovjesom, borovo drvo, završno premazano u tri sloja, prozirni lak, trostruko staklo	1.0	15-55	1.011,20 <b>1.264,00</b>	1.294,40 <b>1.618,00</b>	-
<b>GTU 0070</b>	Ručno upravljanje, s donjom ručkom i dvostrukim ovjesom, bijeli poliuretani oblikovan oko drvene jezgre s dodatnim izdržljivim premazom, dvostruko staklo	1.3	15-55	820,80 <b>1.026,00</b>	1.051,20 <b>1.314,00</b>	-
<b>GTU 0070</b>	Ručno upravljanje, s donjom ručkom i dvostrukim ovjesom, bijeli poliuretani oblikovan oko drvene jezgre s dodatnim izdržljivim premazom, dvostruko staklo	1.3	15-40	-	-	1.166,40 <b>1.458,00</b>
<b>GTU 0066</b>	Ručno upravljanje, s donjom ručkom i dvostrukim ovjesom, bijeli poliuretani oblikovan oko drvene jezgre s dodatnim izdržljivim premazom, trostruko staklo	1.0	15-55	1.148,80 <b>1.436,00</b>	1.471,20 <b>1.839,00</b>	-
<b>GTL 2070</b>	Ručno upravljanje, s donjom ručkom i dvostrukim ovjesom, borovo drvo, završno premazano u tri sloja, obojeno bijelom bojom, dvostruko staklo	1.3	15-55	722,40 <b>903,00</b>	924,80 <b>1.156,00</b>	-
<b>GTL 2066</b>	Ručno upravljanje, s donjom ručkom i dvostrukim ovjesom, borovo drvo, završno premazano u tri sloja, obojeno bijelom bojom, trostruko staklo	1.0	15-55	1.011,20 <b>1.264,00</b>	1.294,40 <b>1.618,00</b>	-

Opšavi su potrebni za ugradnju.

Cijena bez PDV-a (€)  
Cijena s PDV-om (€)

+++ 46x61	024 90x48	025 45x55	029 45x73	033 85x85	034 48x90	103 54x83	

### KROVNI PROZOR ZA NESTAMBENA POTKROVLJA

		Nagib krova							
<b>GVK 0000Z</b>	Bočni ovjes/ Dvostruko stakla/ Unutarnja površina: Poliuretani, crni lak/ Vanjski materijal: Aluminijski, tamnosivi	20-65	152,00 <b>190,00</b>	-	-	-	-	-	-
<b>VLT 1000</b>	Gornji ovjes/ Dvostruko stakla/ Unutarnja površina: Borovo drvo, završno premazano u dva sloja, prozirni lak/ Vanjski materijal: Aluminijski, tamnosivi	20-45	-	143,20 <b>179,00</b>	-	-	-	-	-
<b>VLT 1000</b>	Lijevi ili desni bočni ovjes/ Dvostruko stakla/ Unutarnja površina: Borovo drvo, završno premazano u dva sloja, prozirni lak/ Vanjski materijal: Aluminijski, tamnosivi	20-60	-	-	110,40 <b>138,00</b>	121,60 <b>152,00</b>	243,20 <b>304,00</b>	-	-
<b>VLT 1000</b>	Bočni ovjes ili gornji ovjes/ Dvostruko stakla/ Unutarnja površina: Borovo drvo, završno premazano u dva sloja, prozirni lak/ Vanjski materijal: Aluminijski, tamnosivi	20-60	-	-	-	-	-	148,80 <b>186,00</b>	-
<b>GVT 0059Z</b>	Bočni ovjes/ Dvostruko stakla/ Unutarnja površina: Poliuretani, crni lak/ Vanjski materijal: Aluminijski, tamnosivi	20-65	-	-	-	-	-	-	209,60 <b>262,00</b>
<b>GVT 7759Z</b>	Bočni ovjes/ Dvostruko stakla/ Unutarnja površina: poliuretani, crveni lak/ Vanjski materijal: PUR, brick red	20-65	-	-	-	-	-	-	226,40 <b>283,00</b>

GVT, GVK i VLT prozori s integriranim opšavom.

# PROIZVODI ZA ODRŽAVANJE VELUX KROVNIH PROZORA

Cijena bez PDV-a (€)  
Cijena s PDV-om (€)

## ZAMJENSKA STAKLA

Zamjensko staklo IPL sadrži izoliranu jedinicu ostakljenja isporučenu u sklopivoj kutiji s ugrađenim EPS-om na staklu radi zaštite. Zamjensko staklo IPL isporučuje se u paketu koji uključuje potreban materijal za ugradnju: vijke, butile i upute za ugradnju.

Vrsta/ varijanta stakla	Primjenjivo za generaciju prozora	Staklo (objavljeno)	Ug	Nominalna debljina (M jedinice)																				
<b>Za generaciju prozora V21</b>					<b>C02</b>	<b>C04</b>	<b>C06</b>	<b>F04</b>	<b>F06</b>	<b>F08</b>	<b>M04</b>		<b>M06</b>	<b>M08</b>	<b>M10</b>	<b>P06</b>	<b>P08</b>	<b>P10</b>	<b>S06</b>	<b>S08</b>	<b>S10</b>	<b>U04</b>	<b>U08</b>	<b>U10</b>
IPL 0059	V21	Dvostruko staklo	1,1	23.8 mm	73,60 <b>92,00</b>	78,40 <b>98,00</b>	87,20 <b>109,00</b>	87,20 <b>109,00</b>	91,20 <b>114,00</b>	100,00 <b>125,00</b>	88,80 <b>111,00</b>		96,80 <b>121,00</b>	103,20 <b>129,00</b>	120,00 <b>150,00</b>	113,60 <b>142,00</b>	120,80 <b>151,00</b>	130,40 <b>163,00</b>	119,20 <b>149,00</b>	132,80 <b>166,00</b>	147,20 <b>184,00</b>	121,60 <b>152,00</b>	148,00 <b>185,00</b>	166,40 <b>208,00</b>
IPL 0073G	V21	Dvostruko staklo	1,1	24.4 mm	73,60 <b>92,00</b>	78,40 <b>98,00</b>	87,20 <b>109,00</b>	87,20 <b>109,00</b>	91,20 <b>114,00</b>	100,00 <b>125,00</b>	88,80 <b>111,00</b>		96,80 <b>121,00</b>	103,20 <b>129,00</b>	120,00 <b>150,00</b>	113,60 <b>142,00</b>	120,80 <b>151,00</b>	130,40 <b>163,00</b>	119,20 <b>149,00</b>	132,80 <b>166,00</b>	147,20 <b>184,00</b>	121,60 <b>152,00</b>	148,00 <b>185,00</b>	166,40 <b>208,00</b>
<b>Za generaciju prozora V22</b>					<b>CK02</b>	<b>CK04</b>	<b>CK06</b>	<b>FK04</b>	<b>FK06</b>	<b>FK08</b>	<b>MK04</b>		<b>MK06</b>	<b>MK08</b>	<b>MK10</b>	<b>PK06</b>	<b>PK08</b>	<b>PK10</b>	<b>SK06</b>	<b>SK08</b>	<b>SK10</b>	<b>UK04</b>	<b>UK08</b>	<b>UK10</b>
IPL 0050	V22	Dvostruko staklo	1,0	23.8 mm	73,60 <b>92,00</b>	78,40 <b>98,00</b>	87,20 <b>109,00</b>	87,20 <b>109,00</b>	91,20 <b>114,00</b>	100,00 <b>125,00</b>	88,80 <b>111,00</b>		96,80 <b>121,00</b>	103,20 <b>129,00</b>	120,00 <b>150,00</b>	113,60 <b>142,00</b>	120,80 <b>151,00</b>	130,40 <b>163,00</b>	119,20 <b>149,00</b>	132,80 <b>166,00</b>	147,20 <b>184,00</b>	121,60 <b>152,00</b>	148,00 <b>185,00</b>	166,40 <b>208,00</b>
IPL 0061	V22	Trostruko staklo	0,6	38.6 mm	48,00 <b>60,00</b>	51,20 <b>64,00</b>	- <b>-</b>	56,80 <b>71,00</b>	59,20 <b>74,00</b>	64,80 <b>81,00</b>	57,60 <b>72,00</b>		63,20 <b>79,00</b>	67,20 <b>84,00</b>	78,40 <b>98,00</b>	73,60 <b>92,00</b>	78,40 <b>98,00</b>	- <b>-</b>	77,60 <b>97,00</b>	86,40 <b>108,00</b>	- <b>-</b>	- <b>-</b>	- <b>-</b>	- <b>-</b>
IPL 0068	V22	Trostruko staklo	0,7	37.1 mm	114,40 <b>143,00</b>	121,60 <b>152,00</b>	135,20 <b>169,00</b>	135,20 <b>169,00</b>	140,80 <b>176,00</b>	154,40 <b>193,00</b>	138,40 <b>173,00</b>		150,40 <b>188,00</b>	160,80 <b>201,00</b>	186,40 <b>233,00</b>	175,20 <b>219,00</b>	187,20 <b>234,00</b>	202,40 <b>253,00</b>	184,80 <b>231,00</b>	205,60 <b>257,00</b>	228,00 <b>285,00</b>	188,80 <b>236,00</b>	229,60 <b>287,00</b>	258,40 <b>323,00</b>

U slučaju da trebate zamijeniti drugu varijantu stakla, koja nije gore navedena, ili planirate zamijeniti staklo na drugu debljinu, obratite se VELUX korisničkoj službi za potvrdu dostupnosti i cijene.

Cijena bez PDV-a (€)  
Cijena s PDV-om (€)

Veličine/Dimenzije (cm)	CK00 55x+++	FK00 66x+++	MK00 78x+++	PK00 94x+++	SK00 114x+++	UK00 134x+++
<b>SERVISNI SET ZA SNIJEG I LED</b>						
	Nagib krova					
ZIS 0000	-	68,80 <b>86,00</b>	69,60 <b>87,00</b>	71,20 <b>89,00</b>	74,40 <b>93,00</b>	76,00 <b>95,00</b>
Servisni set za snijeg i led može se naknadno ugraditi na već ugrađen krovni prozor. Set sadrži brtve, posebno pokrivalo donjeg okvira i vijke s brtvilom. Ove komponente čine krovni prozor otpornijim na „nakupljenu“ vodu i ekstremne vremenske uvjete. Samo za prozore s trostrukim ostakljenjem i samo u ugradnjama na crvenoj razini.						

Cijena bez PDV-a (€)  
Cijena s PDV-om (€)

## PROIZVODI ZA ODRŽAVANJE I SERVISIRANJE

<b>ZZZ 220/220K</b>	Set za održavanje VELUX krovni prozora	Sadržaj paketa: 1 x priručnik s uputama 1 x brusni papir 1 x 3 m pjena za ventilacijski preklop (3,5 mm x 38 mm) 1 x 3 m filter za zrak (20 mm x 20 mm) 1 x mast 1 x alat za odvajanje  Dovoljno za 2 – 5 VELUX krovni prozora, ovisno o veličini.	27,20 <b>34,00</b>
---------------------	--	--	-----------------------

## SVJETLOSNI TUNELI

Cijena bez PDV-a (€)				
Cijena s PDV-om (€)				
Promjer (mm)		OK10	OK14	OK14
Veličine/Dimenzije (cm)		250 37x37	350 47x47	350 60x60
<b>SVJETLOSNI TUNELI</b>				
<b>NESAVITLJIVI SVJETLOSNI TUNELI</b>				
<b>TLR 2010</b>	VELUX nesavitljivi svjetlosni tunel TLR za kose krovove (ravni pokrov), 25 cm	376,80 <b>471,00</b>	-	-
<b>TWR 2010</b>	VELUX nesavitljivi svjetlosni tunel TWR za kose krovove (crijep), 25 cm	376,80 <b>471,00</b>	-	-
<b>TLR 2010</b>	VELUX nesavitljivi svjetlosni tunel TLR za kose krovove (ravni pokrov), 35 cm	-	432,80 <b>541,00</b>	-
<b>TWR 2010</b>	VELUX nesavitljivi svjetlosni tunel TWR za kose krovove (crijep), 35 cm	-	432,80 <b>541,00</b>	-
<b>TCR 0010</b>	VELUX nesavitljivi svjetlosni tunel TCR za ravni krov, 35 cm	-	-	558,40 <b>698,00</b>
<b>SAVITLJIVI SVJETLOSNI TUNELI</b>				
<b>TLF 2010</b>	VELUX nesavitljivi svjetlosni tunel TLF za kose krovove (ravni pokrov), 35 cm	-	346,40 <b>433,00</b>	-
<b>TWF 2010</b>	VELUX nesavitljivi svjetlosni tunel TWF za kose krovove (crijep), 35 cm	-	346,40 <b>433,00</b>	-
<b>TCF 0010</b>	VELUX savitljivi svjetlosni tunel TCF za ravni krov, 35 cm	-	-	376,80 <b>471,00</b>
<b>Izolacijska maramica</b>				
<b>BFX 1000</b>	VELUX hidroizolacijska maramica BFX za svjetlosne tunele	92,00 <b>115,00</b>	92,00 <b>115,00</b>	-

Cijena bez PDV-a (€)  
Cijena s PDV-om (€)

<b>SVJETLOSNI TUNELI SA SVJETLOM</b>		
<b>TCF 0010 + ZTL ++</b>	<b>TCF S00C01</b>	436,80 <b>546,00</b>
<b>TCR 0010P1 + TCR 0010P2 + ZTL ++</b>	<b>TCR S00C01</b>	618,40 <b>773,00</b>
<b>TLF 2010 + ZTL ++</b>	<b>TLF S00C01</b>	406,40 <b>508,00</b>
<b>TLR 2010 + ZTL ++</b>	<b>TLR S00C01</b>	492,80 <b>616,00</b>
<b>TWF 2010 + ZTL ++</b>	<b>TWF S00W01</b>	406,40 <b>508,00</b>
<b>TWR 2010 + ZTL ++</b>	<b>TWR S00W01</b>	492,80 <b>616,00</b>

Cijena bez PDV-a (€)  
Cijena s PDV-om (€)

		OK10	OK14
<b>PRODUŽECI ZA NESAVITLJIVE TUNELE</b>			
<b>ZTR 0062</b>	VELUX nesavitljivi produžetak ZTR za svjetlosne tunele	61,60 <b>77,00</b>	64,00 <b>80,00</b>
<b>ZTR 0124</b>	VELUX nesavitljivi produžetak ZTR za svjetlosne tunele	-	83,20 <b>104,00</b>
<b>SET ZA TOPLINSKU IZOLACIJU</b>			
<b>ZTB 2002</b>	Set za bolju U-vrijednost za svjetlosne tunele, ZTB	-	43,20 <b>54,00</b>

Cijena bez PDV-a (€)  
Cijena s PDV-om (€)

<b>PRODUŽETAK OKVIRA ZA SVJETLOSNE TUNELE ZA RAVNI KROV</b>		
<b>ZCE 0015</b>	VELUX potkonstrukcija ZCE za svjetlosne tunele TCF/TCR za ravne krovove	149,60 <b>187,00</b>
<b>SET ZA SVJETLO</b>		
<b>ZTL ++</b>	VELUX set za rasvjetu ZTL za svjetlosne tunele	86,40 <b>108,00</b>

# PROZORI ZA RAVNI KROV

Cijena bez PDV-a (€)  
Cijena s PDV-om (€)

Veličine/Dimenzije (cm)

060060  
60x60

080080  
80x80

090060  
90x60

090090  
90x90

100100  
100x100

120090  
120x90

120120  
120x120

150080  
150x80

150100  
150x100

150120  
150x120

150150  
150x150

200060  
200x60

200100  
200x100

## NOVA GENERACIJA PROZOR ZA RAVNI KROV SA ZAKRIVLJENIM STAKLOM

Kut ugradnje (Min.) Kut ugradnje (Max.)

### Pokrovni element

ISU 1093	VELUX pokrovni element sa zakrivljenim staklom ISU 1093	0	15	497,60 622,00	592,80 741,00	548,80 686,00	659,20 824,00	732,00 915,00	761,60 952,00	952,00 1.190,00	885,60 1.107,00		966,40 1.208,00	1.134,40 1.418,00	1.317,60 1.647,00	1.003,20 1.254,00	1.384,00 1.730,00
----------	---	---	----	------------------	------------------	------------------	------------------	------------------	------------------	--------------------	--------------------	--	--------------------	----------------------	----------------------	----------------------	----------------------

Urc.ref300 W/(m²K) Arc.ref300 m²

### Donji element

CFU 0020Q	VELUX prozor za ravni krov sa staklom CFU, fiksni donji element, dvostruko staklo	0,65	4,4	352,00 440,00	419,20 524,00	388,00 485,00	465,60 582,00	517,60 647,00	538,40 673,00	631,20 789,00	568,80 711,00		647,20 809,00	729,60 912,00	848,80 1.061,00	647,20 809,00	889,60 1.112,00
CFU 0025Q	VELUX prozor za ravni krov sa staklom CFU, fiksni donji element, trostruko staklo	0,55	4,4	457,60 572,00	544,80 681,00	504,80 631,00	605,60 757,00	672,80 841,00	699,20 874,00	820,80 1.026,00	740,00 925,00		840,80 1.051,00	948,80 1.186,00	1.103,20 1.379,00	840,80 1.051,00	1.156,80 1.446,00
CVU 0220Q	VELUX električni prozor za ravni krov sa staklom CVU, donji element, dvostruko staklo	0,65	4,4	1.076,80 1.346,00	1.144,00 1.430,00	1.112,80 1.391,00	1.190,40 1.488,00	1.242,40 1.553,00	1.263,20 1.579,00	1.356,00 1.695,00	1.293,60 1.617,00		1.372,00 1.715,00	1.454,40 1.818,00	1.573,60 1.967,00	1.372,00 1.715,00	1.614,40 2.018,00
CVU 0225Q	VELUX električni prozor za ravni krov sa staklom CVU, donji element, trostruko staklo	0,55	4,4	1.182,40 1.478,00	1.269,60 1.587,00	1.229,60 1.537,00	1.330,40 1.663,00	1.397,60 1.747,00	1.424,00 1.780,00	1.545,60 1.932,00	1.464,80 1.831,00		1.565,60 1.957,00	1.673,60 2.092,00	1.828,00 2.285,00	1.565,60 1.957,00	1.881,60 2.352,00
CVU 0320Q	VELUX solarni prozor za ravni krov sa staklom CVU, osnovna jedinica, dvostruko staklo	0,65	4,4	1.076,80 1.346,00	1.144,00 1.430,00	1.112,80 1.391,00	1.190,40 1.488,00	1.242,40 1.553,00	1.263,20 1.579,00	1.356,00 1.695,00	1.293,60 1.617,00		1.372,00 1.715,00	1.454,40 1.818,00	1.573,60 1.967,00	1.372,00 1.715,00	1.614,40 2.018,00
CVU 0325Q	VELUX solarni prozor za ravni krov sa staklom CVU, osnovna jedinica, trostruko staklo	0,55	4,4	1.182,40 1.478,00	1.269,60 1.587,00	1.229,60 1.537,00	1.330,40 1.663,00	1.397,60 1.747,00	1.424,00 1.780,00	1.545,60 1.932,00	1.464,80 1.831,00		1.565,60 1.957,00	1.673,60 2.092,00	1.828,00 2.285,00	1.565,60 1.957,00	1.881,60 2.352,00

### Dodatna oprema za ugradnju

ZCU 0015	VELUX potkonstrukcija za ravni krov ZCU 0015, s prirubnicom, kompatibilna s prozorima za ravni krov sa staklom CVU i CFU			190,40 238,00	204,00 255,00	201,60 252,00	212,80 266,00	219,20 274,00	221,60 277,00	245,60 307,00	230,40 288,00		254,40 318,00	274,40 343,00	298,40 373,00	263,20 329,00	313,60 392,00
ZCU 1015	VELUX potkonstrukcija za ravni krov ZCU 1015, bez prirubnice, kompatibilna s prozorima za ravni krov sa staklom CVU i CFU			172,00 215,00	183,20 229,00	181,60 227,00	191,20 239,00	197,60 247,00	199,20 249,00	220,80 276,00	207,20 259,00		228,80 286,00	246,40 308,00	268,00 335,00	236,80 296,00	282,40 353,00
ZZZ 210U	VELUX set za osiguravanje pokrovnog materijala za ravni krov za prozore za ravni krov sa staklom CVU/CFU			41,60 52,00	44,80 56,00	44,00 55,00	46,40 58,00	48,00 60,00	48,80 61,00	54,40 68,00	50,40 63,00		56,00 70,00	60,00 75,00	65,60 82,00	57,60 72,00	68,80 86,00
BBX 0000	VELUX parna brana BBX za prozore za ravni krov			31,20 39,00	33,60 42,00	32,80 41,00	35,20 44,00	36,00 45,00	36,00 45,00	40,00 50,00	37,60 47,00		41,60 52,00	44,80 56,00	48,80 61,00	43,20 54,00	51,20 64,00
LSF 2000	VELUX obloga LSF za prozore za ravni krov			272,00 340,00	298,40 373,00	292,00 365,00	311,20 389,00	324,00 405,00	330,40 413,00	349,60 437,00	333,60 417,00		356,80 446,00	363,20 454,00	388,80 486,00	372,80 466,00	404,80 506,00

Svi pravokutni prozori (električni i solarni), otvaraju se na dužoj strani.

Izračunato za referentnu dimenziju od 120x120 cm i visinu od 30 cm, za nagib krova 0°

LSF 2000 – obloga za ravni krov. Sveobuhvatno rješenje uključuje PVC ploče, parnu branu i okvir.

Cijena bez PDV-a (€)																
Cijena s PDV-om (€)																
Veličine/Dimenzije (cm)	060060 60x60	080080 80x80	090060 90x60	090090 90x90	100100 100x100	120090 120x90	120120 120x120	150080 150x80		150100 150x100	150120 150x120	150150 150x150	200060 200x60	200100 200x100		

### NOVA GENERACIJA PROZOR ZA RAVNI KROV S RAVNIM STAKLOM

		Kut ugradnje (Min.)		Kut ugradnje (Max.)																	
<b>Pokrovni element</b>																					
ISU 2093	VELUX pokrovni element s ravnim staklom ISU 2093	2	15	359,20 <b>449,00</b>	428,00 <b>535,00</b>	396,00 <b>495,00</b>	475,20 <b>594,00</b>	528,80 <b>661,00</b>	549,60 <b>687,00</b>	687,20 <b>859,00</b>	639,20 <b>799,00</b>		697,60 <b>872,00</b>	819,20 <b>1.024,00</b>	951,20 <b>1.189,00</b>	724,00 <b>905,00</b>	998,40 <b>1.248,00</b>				
		Urc,ref300 W/(m²K)		Arc,ref300 m²																	
<b>Donji element</b>																					
CFU 0020Q	VELUX prozor za ravni krov sa staklom CFU, fiksni donji element, dvostruko staklo	0.75	4.1	352,00 <b>440,00</b>	419,20 <b>524,00</b>	388,00 <b>485,00</b>	465,60 <b>582,00</b>	517,60 <b>647,00</b>	538,40 <b>673,00</b>	631,20 <b>789,00</b>	568,80 <b>711,00</b>		647,20 <b>809,00</b>	729,60 <b>912,00</b>	848,80 <b>1.061,00</b>	647,20 <b>809,00</b>	889,60 <b>1.112,00</b>				
CFU 0025Q	VELUX prozor za ravni krov sa staklom CFU, fiksni donji element, trostruko staklo	0.60	4.1	457,60 <b>572,00</b>	544,80 <b>681,00</b>	504,80 <b>631,00</b>	605,60 <b>757,00</b>	672,80 <b>841,00</b>	699,20 <b>874,00</b>	820,80 <b>1.026,00</b>	740,00 <b>925,00</b>		840,80 <b>1.051,00</b>	948,80 <b>1.186,00</b>	1.103,20 <b>1.379,00</b>	840,80 <b>1.051,00</b>	1.156,80 <b>1.446,00</b>				
CVU 0220Q	VELUX električni prozor za ravni krov sa staklom CVU, donji element, dvostruko ostakljenje	0.75	4.1	1.076,80 <b>1.346,00</b>	1.144,00 <b>1.430,00</b>	1.112,80 <b>1.391,00</b>	1.190,40 <b>1.488,00</b>	1.242,40 <b>1.553,00</b>	1.263,20 <b>1.579,00</b>	1.356,00 <b>1.695,00</b>	1.293,60 <b>1.617,00</b>		1.372,00 <b>1.715,00</b>	1.454,40 <b>1.818,00</b>	1.573,60 <b>1.967,00</b>	1.372,00 <b>1.715,00</b>	1.614,40 <b>2.018,00</b>				
CVU 0225Q	VELUX električni prozor za ravni krov sa staklom CVU, donji element, trostruko staklo	0.60	4.1	1.182,40 <b>1.478,00</b>	1.269,60 <b>1.587,00</b>	1.229,60 <b>1.537,00</b>	1.330,40 <b>1.663,00</b>	1.397,60 <b>1.747,00</b>	1.424,00 <b>1.780,00</b>	1.545,60 <b>1.932,00</b>	1.464,80 <b>1.831,00</b>		1.565,60 <b>1.957,00</b>	1.673,60 <b>2.092,00</b>	1.828,00 <b>2.285,00</b>	1.565,60 <b>1.957,00</b>	1.881,60 <b>2.352,00</b>				
CVU 0320Q	VELUX solarni prozor za ravni krov sa staklom CVU, osnovna jedinica, dvostruko ostakljenje	0.75	4.1	1.076,80 <b>1.346,00</b>	1.144,00 <b>1.430,00</b>	1.112,80 <b>1.391,00</b>	1.190,40 <b>1.488,00</b>	1.242,40 <b>1.553,00</b>	1.263,20 <b>1.579,00</b>	1.356,00 <b>1.695,00</b>	1.293,60 <b>1.617,00</b>		1.372,00 <b>1.715,00</b>	1.454,40 <b>1.818,00</b>	1.573,60 <b>1.967,00</b>	1.372,00 <b>1.715,00</b>	1.614,40 <b>2.018,00</b>				
CVU 0325Q	VELUX solarni prozor za ravni krov sa staklom CVU, osnovna jedinica, trostruko staklo	0.60	4.1	1.182,40 <b>1.478,00</b>	1.269,60 <b>1.587,00</b>	1.229,60 <b>1.537,00</b>	1.330,40 <b>1.663,00</b>	1.397,60 <b>1.747,00</b>	1.424,00 <b>1.780,00</b>	1.545,60 <b>1.932,00</b>	1.464,80 <b>1.831,00</b>		1.565,60 <b>1.957,00</b>	1.673,60 <b>2.092,00</b>	1.828,00 <b>2.285,00</b>	1.565,60 <b>1.957,00</b>	1.881,60 <b>2.352,00</b>				
<b>Dodatna oprema za ugradnju</b>																					
ZCU 0015	VELUX potkonstrukcija za ravni krov ZCU 0015, s prirubnicom, kompatibilna s prozorima za ravni krov sa staklom CVU i CFU			190,40 <b>238,00</b>	204,00 <b>255,00</b>	201,60 <b>252,00</b>	212,80 <b>266,00</b>	219,20 <b>274,00</b>	221,60 <b>277,00</b>	245,60 <b>307,00</b>	230,40 <b>288,00</b>		254,40 <b>318,00</b>	274,40 <b>343,00</b>	298,40 <b>373,00</b>	263,20 <b>329,00</b>	313,60 <b>392,00</b>				
ZCU 1015	VELUX potkonstrukcija za ravni krov ZCU 1015, bez prirubnice, kompatibilna s prozorima za ravni krov sa staklom CVU i CFU			172,00 <b>215,00</b>	183,20 <b>229,00</b>	181,60 <b>227,00</b>	191,20 <b>239,00</b>	197,60 <b>247,00</b>	199,20 <b>249,00</b>	220,80 <b>276,00</b>	207,20 <b>259,00</b>		228,80 <b>286,00</b>	246,40 <b>308,00</b>	268,00 <b>335,00</b>	236,80 <b>296,00</b>	282,40 <b>353,00</b>				
ZZZ 210U	VELUX set za osiguravanje pokrovnog materijala za ravni krov za prozore za ravni krov sa staklom CVU/CFU			41,60 <b>52,00</b>	44,80 <b>56,00</b>	44,00 <b>55,00</b>	46,40 <b>58,00</b>	48,00 <b>60,00</b>	48,80 <b>61,00</b>	54,40 <b>68,00</b>	50,40 <b>63,00</b>		56,00 <b>70,00</b>	60,00 <b>75,00</b>	65,60 <b>82,00</b>	57,60 <b>72,00</b>	68,80 <b>86,00</b>				
BBX 0000	VELUX parna brana BBX za prozore za ravni krov			31,20 <b>39,00</b>	33,60 <b>42,00</b>	32,80 <b>41,00</b>	35,20 <b>44,00</b>	36,00 <b>45,00</b>	36,00 <b>45,00</b>	40,00 <b>50,00</b>	37,60 <b>47,00</b>		41,60 <b>52,00</b>	44,80 <b>56,00</b>	48,80 <b>61,00</b>	43,20 <b>54,00</b>	51,20 <b>64,00</b>				
LSF 2000	VELUX obloga LSF za prozore za ravni krov			272,00 <b>340,00</b>	298,40 <b>373,00</b>	292,00 <b>365,00</b>	311,20 <b>389,00</b>	324,00 <b>405,00</b>	330,40 <b>413,00</b>	349,60 <b>437,00</b>	333,60 <b>417,00</b>		356,80 <b>446,00</b>	363,20 <b>454,00</b>	388,80 <b>486,00</b>	372,80 <b>466,00</b>	404,80 <b>506,00</b>				

Svi pravokutni prozori (električni i solarni), otvaraju se na dužoj strani.  
 Izračunato za referentnu dimenziju od 120x120 cm i visinu od 30 cm, za nagib krova 0°  
 LSF 2000 – obloga za ravni krov. Sveobuhvatno rješenje uključuje PVC ploče, parnu branu i okvir.

Cijena bez PDV-a (€)															
Cijena s PDV-om (€)															
Veličine/Dimenzije (cm)	060060	080080	090060	090090	100100	120090	120120	150080		150100	150120	150150	200060	200100	
<b>SJENILA ZA PROZORE ZA RAVNI KROV SA ZAKRIVLJENIM I RAVNIM STAKLOM</b>															
DSU	VELUX solarno sjenilo za zamračenje DSU za prozore za ravni krov s kupolom	350,40 <b>438,00</b>	365,60 <b>457,00</b>	358,40 <b>448,00</b>	373,60 <b>467,00</b>	380,80 <b>476,00</b>	388,80 <b>486,00</b>	396,00 <b>495,00</b>	392,00 <b>490,00</b>		404,00 <b>505,00</b>	434,40 <b>543,00</b>	476,00 <b>595,00</b>	426,40 <b>533,00</b>	499,20 <b>624,00</b>
MSU	VELUX solarno sjenilo za zaštitu od vrućine MSU za prozore za ravni krov sa staklom	350,40 <b>438,00</b>	365,60 <b>457,00</b>	358,40 <b>448,00</b>	373,60 <b>467,00</b>	380,80 <b>476,00</b>	388,80 <b>486,00</b>	396,00 <b>495,00</b>	392,00 <b>490,00</b>		404,00 <b>505,00</b>	434,40 <b>543,00</b>	476,00 <b>595,00</b>	426,40 <b>533,00</b>	499,20 <b>624,00</b>
ZIU	VELUX komarnik ZIU za prozore za ravni krov	88,00 <b>110,00</b>	91,20 <b>114,00</b>	89,60 <b>112,00</b>	93,60 <b>117,00</b>	95,20 <b>119,00</b>	96,80 <b>121,00</b>	99,20 <b>124,00</b>	98,40 <b>123,00</b>		100,80 <b>126,00</b>	108,80 <b>136,00</b>	119,20 <b>149,00</b>	106,40 <b>133,00</b>	124,80 <b>156,00</b>

Sjenilo se postavlja unutar prozora za ravni krov pa je najprikladnije sjenilo postaviti tijekom ugradnje prozora.  
 Kompatibilno s novom generacijom CVU i CFU krovnih prozora s ravnim i zakrivljenim staklom.  
 Komarnik se može kombinirati sa sjenilom za zaštitu od vrućine ili sjenilom za zamračenje. Ali DSU i MSU ne mogu zajedno ugraditi.

Cijena bez PDV-a (€) Cijena s PDV-om (€)		060060	060090	080080	090090	090120	100100	100150	120120	150150		
Veličine/Dimenzije (cm)		60x60	60x90	80x80	90x90	90x120	100x100	100x150	120x120	150x150		
<b>PROZOR ZA RAVNI KROV S KUPOLOM</b>												
		Kut ugradnje (Min.)		Kut ugradnje (Max.)								
<b>Pokrovni element</b>												
<b>ISD 0000</b>	VELUX prozirna akrilna kupola ISD 0000	0	15	200,80 <b>251,00</b>	221,60 <b>277,00</b>	239,20 <b>299,00</b>	265,60 <b>332,00</b>	307,20 <b>384,00</b>	295,20 <b>369,00</b>	389,60 <b>487,00</b>	384,00 <b>480,00</b>	531,20 <b>664,00</b>
<b>ISD 0010</b>	VELUX prozirna kupola od polikarbonata ISD 0010	0	15	216,80 <b>271,00</b>	239,20 <b>299,00</b>	258,40 <b>323,00</b>	287,20 <b>359,00</b>	331,20 <b>414,00</b>	319,20 <b>399,00</b>	420,80 <b>526,00</b>	414,40 <b>518,00</b>	573,60 <b>717,00</b>
<b>ISD 0100</b>	VELUX mliječno bijela akrilna kupola ISD 0100	0	15	200,80 <b>251,00</b>	221,60 <b>277,00</b>	239,20 <b>299,00</b>	265,60 <b>332,00</b>	307,20 <b>384,00</b>	295,20 <b>369,00</b>	389,60 <b>487,00</b>	384,00 <b>480,00</b>	531,20 <b>664,00</b>
<b>ISD 0110</b>	VELUX neprozirna kupola od polikarbonata ISD 0110	0	15	216,80 <b>271,00</b>	239,20 <b>299,00</b>	258,40 <b>323,00</b>	287,20 <b>359,00</b>	331,20 <b>414,00</b>	319,20 <b>399,00</b>	420,80 <b>526,00</b>	414,40 <b>518,00</b>	573,60 <b>717,00</b>
<b>U-vrijednost W/(m²K)</b>												
<b>Donji element</b>												
<b>CFP 0073QV</b>	VELUX fiksni protuprovalni električni prozor za ravni krov s kupolom CFP ---- Q	0.80		320,00 <b>400,00</b>	352,80 <b>441,00</b>	380,80 <b>476,00</b>	423,20 <b>529,00</b>	489,60 <b>612,00</b>	470,40 <b>588,00</b>	588,00 <b>735,00</b>	573,60 <b>717,00</b>	771,20 <b>964,00</b>
<b>CFP 0073</b>	VELUX fiksni prozor za ravni krov s kupolom CFP U	0.87		201,60 <b>252,00</b>	222,40 <b>278,00</b>	240,00 <b>300,00</b>	266,40 <b>333,00</b>	308,00 <b>385,00</b>	296,00 <b>370,00</b>	370,40 <b>463,00</b>	361,60 <b>452,00</b>	486,40 <b>608,00</b>
<b>CVP 0073U</b>	VELUX prozor za ravni krov s kupolom s ručnim upravljanjem CVP 0073U	0.87		437,60 <b>547,00</b>	470,40 <b>588,00</b>	498,40 <b>623,00</b>	540,80 <b>676,00</b>	607,20 <b>759,00</b>	588,00 <b>735,00</b>	705,60 <b>882,00</b>	691,20 <b>864,00</b>	-
<b>CVP 0573</b>	VELUX električni prozor za ravni krov CVP	0.87		640,00 <b>800,00</b>	672,80 <b>841,00</b>	700,80 <b>876,00</b>	743,20 <b>929,00</b>	809,60 <b>1.012,00</b>	790,40 <b>988,00</b>	908,00 <b>1.135,00</b>	893,60 <b>1.117,00</b>	1.091,20 <b>1.364,00</b>
<b>CVP 0673QV</b>	VELUX protuprovalni električni prozor za ravni krov CVP ----QA	0.80		809,60 <b>1.012,00</b>	842,40 <b>1.053,00</b>	870,40 <b>1.088,00</b>	912,80 <b>1.141,00</b>	979,20 <b>1.224,00</b>	960,00 <b>1.200,00</b>	1.077,60 <b>1.347,00</b>	1.063,20 <b>1.329,00</b>	1.260,80 <b>1.576,00</b>
<b>Dodatna oprema za ugradnju</b>												
<b>BBX 0000</b>	VELUX parna brana BBX za prozore za ravni krov			31,20 <b>39,00</b>	32,80 <b>41,00</b>	33,60 <b>42,00</b>	35,20 <b>44,00</b>	36,00 <b>45,00</b>	36,00 <b>45,00</b>	41,60 <b>52,00</b>	40,00 <b>50,00</b>	48,80 <b>61,00</b>
<b>LSF 2000</b>	VELUX obloga LSF za prozore za ravni krov			272,00 <b>340,00</b>	292,00 <b>365,00</b>	298,40 <b>373,00</b>	311,20 <b>389,00</b>	330,40 <b>413,00</b>	324,00 <b>405,00</b>	356,80 <b>446,00</b>	349,60 <b>437,00</b>	388,80 <b>486,00</b>
<b>ZCE 0015</b>	VELUX potkonstrukcija za ravni krov ZCE 0015, s priрубnicom, kompatibilna s prozorom za ravni krov s kupolom			190,40 <b>238,00</b>	201,60 <b>252,00</b>	204,00 <b>255,00</b>	212,80 <b>266,00</b>	221,60 <b>277,00</b>	219,20 <b>274,00</b>	254,40 <b>318,00</b>	245,60 <b>307,00</b>	298,40 <b>373,00</b>
<b>ZCE 1015</b>	VELUX potkonstrukcija za ravni krov ZCE 1015, bez priрубnice, kompatibilna s prozorom za ravni krov s kupolom			172,00 <b>215,00</b>	181,60 <b>227,00</b>	183,20 <b>229,00</b>	191,20 <b>239,00</b>	199,20 <b>249,00</b>	197,60 <b>247,00</b>	228,80 <b>286,00</b>	220,80 <b>276,00</b>	268,00 <b>335,00</b>
<b>ZZZ 210</b>	VELUX set za osiguravanje pokrovnog materijala za ravni krov ZZZ 210 za prozor za ravni krov s kupolom			41,60 <b>52,00</b>	44,00 <b>55,00</b>	44,80 <b>56,00</b>	46,40 <b>58,00</b>	48,80 <b>61,00</b>	48,00 <b>60,00</b>	56,00 <b>70,00</b>	54,40 <b>68,00</b>	65,60 <b>82,00</b>

Svi pravokutni prozori (električni i solarni), otvaraju se na dužoj strani.

Izračunato za referentnu dimenziju 120x120 cm s visinom potkonstrukcije od 30 cm; na 0° krovnog nagiba.

LSF 2000 – obloga za ravni krov. Sveobuhvatno rješenje uključuje PVC ploče, parnu branu i okvir.

Cijena bez PDV-a (€) Cijena s PDV-om (€)		060060	060090	080080	090090	090120	100100	100150	120120	150150
<b>SJENILA ZA PROZORE ZA RAVNI KROV SA KUPOLOM</b>										
<b>FMG</b>	VELUX električno plisirano sjenilo za zasjenjenje FMG za prozore za ravni krov s kupolom	264,80 <b>331,00</b>	270,40 <b>338,00</b>	276,00 <b>345,00</b>	281,60 <b>352,00</b>	293,60 <b>367,00</b>	288,00 <b>360,00</b>	304,80 <b>381,00</b>	299,20 <b>374,00</b>	-
<b>FMK</b>	VELUX električno energetsko sjenilo za zamračenje FMK s bočnim vodilicama bijele boje za prozore za ravni krov s kupolom	296,80 <b>371,00</b>	303,20 <b>379,00</b>	309,60 <b>387,00</b>	316,00 <b>395,00</b>	328,80 <b>411,00</b>	322,40 <b>403,00</b>	341,60 <b>427,00</b>	335,20 <b>419,00</b>	403,20 <b>504,00</b>
<b>FSK</b>	VELUX solarno energetsko plisirano sjenilo za zatamnjenje FSK s bijelim bočnim vodilicama za prozore za ravni krov	296,80 <b>371,00</b>	303,20 <b>379,00</b>	309,60 <b>387,00</b>	316,00 <b>395,00</b>	328,80 <b>411,00</b>	322,40 <b>403,00</b>	341,60 <b>427,00</b>	335,20 <b>419,00</b>	403,20 <b>504,00</b>
<b>MSG</b>	VELUX solarno sjenilo za zaštitu od vrućine MSG za prozore za ravni krov sa kupolom	292,00 <b>365,00</b>	298,40 <b>373,00</b>	304,80 <b>381,00</b>	311,20 <b>389,00</b>	324,00 <b>405,00</b>	317,60 <b>397,00</b>	336,80 <b>421,00</b>	330,40 <b>413,00</b>	-

Za električna sjenila FMK koja se ugrađuju na fiksne prozore CFP potrebno je naručiti KUX 110 kontrolnu jedinicu.

Boje plisiranih sjenila: FMG: 1016 – bijela boja, 1259 – boja pijeska, FMK/FSK: 1045 – bijela boja, 1047 – crna boja.

MSG i FSK nisu kompatibilni s mliječnom kupolom.

FMK/FMG/FSK se mogu kombinirati s vanjskom tendom na solarno napajanje MSG.

Cijena bez PDV-a (€)															
Cijena s PDV-om (€)															
Veličine/Dimenzije (cm)		060060	080080	090060	090090	100100	120090	120120	150100	150150	200100				
		60x60	80x80	90x60	90x90	100x100	120x90	120x120	150x100	150x150	200x100				
<b>KUPOLA</b>															
		<b>Kut ugradnje (Min.)</b>		<b>Kut ugradnje (Max.)</b>											
<b>Pokrovni element</b>															
<b>ISJ 0102</b>	VELUX dvoslojna neprozirna akrilna kupola ISJ 0102	0	15	155,20 <b>194,00</b>	184,80 <b>231,00</b>	171,20 <b>214,00</b>	205,60 <b>257,00</b>	228,00 <b>285,00</b>	236,80 <b>296,00</b>	296,80 <b>371,00</b>	300,80 <b>376,00</b>		410,40 <b>513,00</b>	431,20 <b>539,00</b>	
<b>ISJ 0103</b>	VELUX troslojna neprozirna akrilna kupola ISJ 0103	0	15	209,60 <b>262,00</b>	249,60 <b>312,00</b>	231,20 <b>289,00</b>	276,80 <b>346,00</b>	308,00 <b>385,00</b>	320,00 <b>400,00</b>	400,00 <b>500,00</b>	406,40 <b>508,00</b>		554,40 <b>693,00</b>	581,60 <b>727,00</b>	
<b>ISJ 0112</b>	VELUX neprozirna kupola od polikarbonata ISJ 0112	0	15	178,40 <b>223,00</b>	212,00 <b>265,00</b>	196,80 <b>246,00</b>	236,00 <b>295,00</b>	262,40 <b>328,00</b>	272,80 <b>341,00</b>	340,80 <b>426,00</b>	346,40 <b>433,00</b>		472,00 <b>590,00</b>	495,20 <b>619,00</b>	
<b>ISJ 0113</b>	VELUX neprozirna akrilna kupola ISJ 0113	0	15	240,00 <b>300,00</b>	286,40 <b>358,00</b>	264,80 <b>331,00</b>	318,40 <b>398,00</b>	353,60 <b>442,00</b>	367,20 <b>459,00</b>	459,20 <b>574,00</b>	466,40 <b>583,00</b>		636,00 <b>795,00</b>	668,00 <b>835,00</b>	
		<b>U-vrijednost s donjim elementom 2-struko staklo W/(m²K)</b>				<b>U-vrijednost s donjim elementom 3-struko staklo W/(m²K)</b>									
<b>Donji element</b>															
<b>CFJ 0010</b>	VELUX fiksna kupola CFJ, 15 cm	2.2	1.7	189,60 <b>237,00</b>	226,40 <b>283,00</b>	209,60 <b>262,00</b>	251,20 <b>314,00</b>	279,20 <b>349,00</b>	290,40 <b>363,00</b>	340,80 <b>426,00</b>	348,80 <b>436,00</b>		457,60 <b>572,00</b>	480,00 <b>600,00</b>	
<b>CFJ 1010</b>	VELUX fiksna kupola CFJ, 30 cm	2.2	1.7	237,60 <b>297,00</b>	282,40 <b>353,00</b>	261,60 <b>327,00</b>	314,40 <b>393,00</b>	348,80 <b>436,00</b>	363,20 <b>454,00</b>	425,60 <b>532,00</b>	436,00 <b>545,00</b>		572,00 <b>715,00</b>	-	
<b>CFJ 2020</b>	VELUX fiksna kupola CFJ, 50 cm	2.1	1.7	436,80 <b>546,00</b>	520,00 <b>650,00</b>	481,60 <b>602,00</b>	577,60 <b>722,00</b>	642,40 <b>803,00</b>	668,00 <b>835,00</b>	783,20 <b>979,00</b>	802,40 <b>1.003,00</b>		1.052,80 <b>1.316,00</b>	-	
<b>CVJ 0210</b>	VELUX kupola s ventilacijom CVJ, 15 cm	2.0	1.6	678,40 <b>848,00</b>	715,20 <b>894,00</b>	698,40 <b>873,00</b>	740,00 <b>925,00</b>	768,00 <b>960,00</b>	779,20 <b>974,00</b>	829,60 <b>1.037,00</b>	837,60 <b>1.047,00</b>		946,40 <b>1.183,00</b>	968,80 <b>1.211,00</b>	
<b>CVJ 1210</b>	VELUX kupola s ventilacijom CVJ, 30 cm	2.0	1.6	756,00 <b>945,00</b>	792,80 <b>991,00</b>	776,00 <b>970,00</b>	817,60 <b>1.022,00</b>	845,60 <b>1.057,00</b>	856,80 <b>1.071,00</b>	907,20 <b>1.134,00</b>	915,20 <b>1.144,00</b>		1.024,00 <b>1.280,00</b>	-	
<b>CVJ 2220</b>	VELUX ventilacijska kupola CVJ, 50 cm	2.0	1.6	1.063,20 <b>1.329,00</b>	1.100,00 <b>1.375,00</b>	1.083,20 <b>1.354,00</b>	1.124,80 <b>1.406,00</b>	1.152,80 <b>1.441,00</b>	1.164,00 <b>1.455,00</b>	1.214,40 <b>1.518,00</b>	1.222,40 <b>1.528,00</b>		1.331,20 <b>1.664,00</b>	-	
<b>Dodatna oprema za ugradnju</b>															
<b>ZCJ 0000</b>	VELUX zamjenski okvir ZCJ 0000 za VELUX kupolu			143,20 <b>179,00</b>	157,60 <b>197,00</b>	150,40 <b>188,00</b>	165,60 <b>207,00</b>	172,80 <b>216,00</b>	180,00 <b>225,00</b>	205,60 <b>257,00</b>	223,20 <b>279,00</b>		-	-	
<b>ZCJ 1112</b>	VELUX set za zamjenu za ručnu ventilaciju ZCJ 1112 za VELUX kupolu			316,00 <b>395,00</b>	316,00 <b>395,00</b>	316,00 <b>395,00</b>	316,00 <b>395,00</b>	316,00 <b>395,00</b>	316,00 <b>395,00</b>	316,00 <b>395,00</b>	316,00 <b>395,00</b>		-	-	
<b>ZCJ 1210</b>	VELUX set za zamjenu za električnu ventilaciju ZCJ 1210 za VELUX kupolu			488,80 <b>611,00</b>	488,80 <b>611,00</b>	-	488,80 <b>611,00</b>	488,80 <b>611,00</b>	-	488,80 <b>611,00</b>	-		-	-	
<b>ZZZ 210J</b>	VELUX set za osiguravanje pokrovnog materijala ZZZ 210J za VELUX kupolu			60,80 <b>76,00</b>	64,80 <b>81,00</b>	64,00 <b>80,00</b>	67,20 <b>84,00</b>	69,60 <b>87,00</b>	70,40 <b>88,00</b>	77,60 <b>97,00</b>	80,80 <b>101,00</b>		94,40 <b>118,00</b>	-	
<b>ZZZ 257</b>	VELUX zaštita od propadanja ZZZ 257 za VELUX kupolu			96,80 <b>121,00</b>	139,20 <b>174,00</b>	125,60 <b>157,00</b>	164,00 <b>205,00</b>	190,40 <b>238,00</b>	198,40 <b>248,00</b>	245,60 <b>307,00</b>	256,80 <b>321,00</b>		346,40 <b>433,00</b>	-	

Svi pravokutni prozori (električni i solarni), otvaraju se na dužoj strani.  
Izračunato za referentnu dimenziju 120x120 cm s visinom potkonstrukcije od 30 cm; na 0° krovnog nagiba.



Cijena bez PDV-a (€)  
Cijena s PDV-om (€)

	MK04 78x98	MK06 78x118	MK08 78x140	PK06 94x118	PK08 94x140	SK06 114x118	SK08 114x140	UK04 134x98	UK08 134x140

ODIMLJAVANJE		W/(m <sup>2</sup> K)		Nagib krova											
<b>GGL 307040D</b>	Borovo drvo, završno premazano u tri sloja, prozirni lak, dvostruko staklo	1.3	15-60	763,20 <b>954,00</b>	796,80 <b>996,00</b>	826,40 <b>1.033,00</b>	868,00 <b>1.085,00</b>	901,60 <b>1.127,00</b>	893,60 <b>1.117,00</b>	952,00 <b>1.190,00</b>	905,60 <b>1.132,00</b>		1.019,20 <b>1.274,00</b>		
<b>GGL 306640D</b>	Borovo drvo, završno premazano u tri sloja, prozirni lak, trostruko staklo	1.0	15-60	917,60 <b>1.147,00</b>	964,80 <b>1.206,00</b>	1.005,60 <b>1.257,00</b>	1.064,00 <b>1.330,00</b>	1.111,20 <b>1.389,00</b>	1.099,20 <b>1.374,00</b>	1.181,60 <b>1.477,00</b>	1.116,80 <b>1.396,00</b>		1.275,20 <b>1.594,00</b>		
<b>GGU 007040D</b>	Bijeli poliuretani oblikovan oko drvene jezgre s dodatnim izdržljivim premazom, dvostruko staklo	1.3	15-60	860,00 <b>1.075,00</b>	901,60 <b>1.127,00</b>	938,40 <b>1.173,00</b>	990,40 <b>1.238,00</b>	1.032,80 <b>1.291,00</b>	1.022,40 <b>1.278,00</b>	1.095,20 <b>1.369,00</b>	1.037,60 <b>1.297,00</b>		1.179,20 <b>1.474,00</b>		
<b>GGU 006640D</b>	Bijeli poliuretani oblikovan oko drvene jezgre s dodatnim izdržljivim premazom, trostruko staklo	1.0	15-60	1.052,80 <b>1.316,00</b>	1.111,20 <b>1.389,00</b>	1.162,40 <b>1.453,00</b>	1.236,00 <b>1.545,00</b>	1.294,40 <b>1.618,00</b>	1.280,00 <b>1.600,00</b>	1.382,40 <b>1.728,00</b>	1.301,60 <b>1.627,00</b>		1.500,00 <b>1.875,00</b>		

Opšavi su potrebni za ugradnju.

Geometrijska površina za odimljavanje (Av) u m <sup>2</sup> (ista površina za prozore s i bez usmjerivača vjetra)	0,63	0,77	0,92	0,95	1,14	1,17	1,40	1,13		1,67
Aerodinamična površina za odimljavanje (Aa) u m <sup>2</sup> za prozor za odimljavanje s usmjerivačem vjetra	0,36	0,46	0,59	0,53	0,68	0,61	0,77	0,54		0,83
Aerodinamična površina za odimljavanje (Aa) u m <sup>2</sup> za prozor za odimljavanje bez usmjerivača vjetra	0,19	0,29	0,43	0,30	0,46	0,28	0,44	0,16		0,38

Klasifikacija prema parametrima europskog propisa EN 12 101-2		
Karakteristike	Vrijednost	
Sigurnost tijekom uporabe (Re)	Re 1 000 + 10 000	
Otvaranje pod opterećenjem (SL)	<b>Za kosi krov:</b> Sve dimenzije: = SL1000	<b>Za ravni krov:</b> Dimenzija 100x100 = SL1000 Dimenzija 120x120 = SL500
Niska vanjska temperatura (T)	T (-15)	
Nosivost na opterećenje vjetrom (WL)	WL 3000	
Otpornost na toplinu (B)	B 300	
Reakcija na požar (klasa)	Reakcija na požar GGL 40D: C-s1, d2 Reakcija na požar GGU 40D: D-s2, d2 Reakcija na požar CSP: B-S1, d0	

Za više informacija posjetite velux.hr. Zadržavamo pravo izmjene specifikacija.

Cijena bez PDV-a (€)  
Cijena s PDV-om (€)

Veličine/Dimenzije (cm)

090120 90x120	100100 100x100	120120 120x120

PROZORI ZA RAVNI KROV SA POSEBNIM FUNKCIJAMA						
		Kut ugradnje (Min.)	Kut ugradnje (Max.)			
Pokrovni element						
<b>ISD 0000</b>	VELUX prozirna akrilna kupola ISD 0000	0	15	307,20 <b>384,00</b>	295,20 <b>369,00</b>	384,00 <b>480,00</b>
<b>ISD 0010</b>	VELUX prozirna kupola od polikarbonata ISD 0010	0	15	331,20 <b>414,00</b>	319,20 <b>399,00</b>	414,40 <b>518,00</b>
<b>ISD 0100</b>	VELUX mlječno bijela akrilna kupola ISD 0100	0	15	307,20 <b>384,00</b>	295,20 <b>369,00</b>	384,00 <b>480,00</b>
<b>ISD 0110</b>	VELUX neprozirna kupola od polikarbonata ISD 0110	0	15	331,20 <b>414,00</b>	319,20 <b>399,00</b>	414,40 <b>518,00</b>
U-vrijednost W/(m <sup>2</sup> K)						
Donji element						
<b>CXP 0473Q</b>	VELUX izlazni prozor s ručnim upravljanjem za ravni krov s kupolom CXP	0,86		978,40 <b>1.223,00</b>	940,80 <b>1.176,00</b>	1.148,00 <b>1.435,00</b>
<b>CSP 1073Q</b>	VELUX prozor za odimljavanje za ravni krov CSP	0,99		-	1.716,80 <b>2.146,00</b>	2.094,40 <b>2.618,00</b>
Dodatna oprema za ugradnju						
<b>BBX 0000</b>	VELUX parna brana BBX za prozore za ravni krov			36,00 <b>45,00</b>	36,00 <b>45,00</b>	40,00 <b>50,00</b>
<b>LSF 2000</b>	VELUX obloga LSF za prozore za ravni krov			330,40 <b>413,00</b>	324,00 <b>405,00</b>	349,60 <b>437,00</b>
<b>ZCE 0015</b>	VELUX potkonstrukcija za ravni krov ZCE 0015, s priрубnicom, kompatibilna s prozorom za ravni krov s kupolom			221,60 <b>277,00</b>	219,20 <b>274,00</b>	245,60 <b>307,00</b>
<b>ZCE 1015</b>	VELUX potkonstrukcija za ravni krov ZCE 1015, bez priрубnice, kompatibilna s prozorom za ravni krov s kupolom			199,20 <b>249,00</b>	197,60 <b>247,00</b>	220,80 <b>276,00</b>
<b>ZZZ 210</b>	VELUX set za osiguravanje pokrovnog materijala za ravni krov ZZZ 210 za prozor za ravni krov s kupolom			48,80 <b>61,00</b>	48,00 <b>60,00</b>	54,40 <b>68,00</b>

Cijena bez PDV-a (€)  
Cijena s PDV-om (€)

#### DODATNA OPREMA ZA ODIMLJAVANJE

<b>KFA 100 WW</b>	VELUX senzor za dim KFA 100		140,80 <b>176,00</b>
<b>KFC 210 EU</b>	VELUX kontrolna jedinica KFC 210		786,40 <b>983,00</b>
<b>KFC 220 EU</b>	VELUX kontrolna jedinica KFC 220		1.162,40 <b>1.453,00</b>
<b>KFK 100 WW</b>	VELUX jedinica za aktivaciju KFK 100		90,40 <b>113,00</b>
<b>KFK 200 WW</b>	VELUX prekidač za ventilaciju KFK 200		88,00 <b>110,00</b>
<b>KFX 210 EU</b>	VELUX kontrolni sustav KFX 210		987,20 <b>1.234,00</b>
<b>KLA 200 WW</b>	VELUX senzor za kišu KLA 200		48,00 <b>60,00</b>

Kod pravokutnih dimenzija motor se nalazi na kraćoj strani prozora. Izračunato za referentnu dimenziju 120x120 cm s visinom potkonstrukcije od 30 cm; na 0° krovnog nagiba. LSF 2000 – obloga za ravni krov. Sveobuhvatno rješenje uključuje PVC ploče, parnu branu i okvir. Sjenila nisu kompatibilna s CXP izlazom na ravni krov. CSP: FMG i FMK nisu kompatibilni s CSP krovnim prozorom. MSG i FSK mogu se instalirati s CSP krovnim prozorom (ovisno o lokalnim propisima). ZCE 0015/1015 nisu kompatibilni s CSP krovnim prozorom.

#### Dijagram ožičenja – za kosi krov

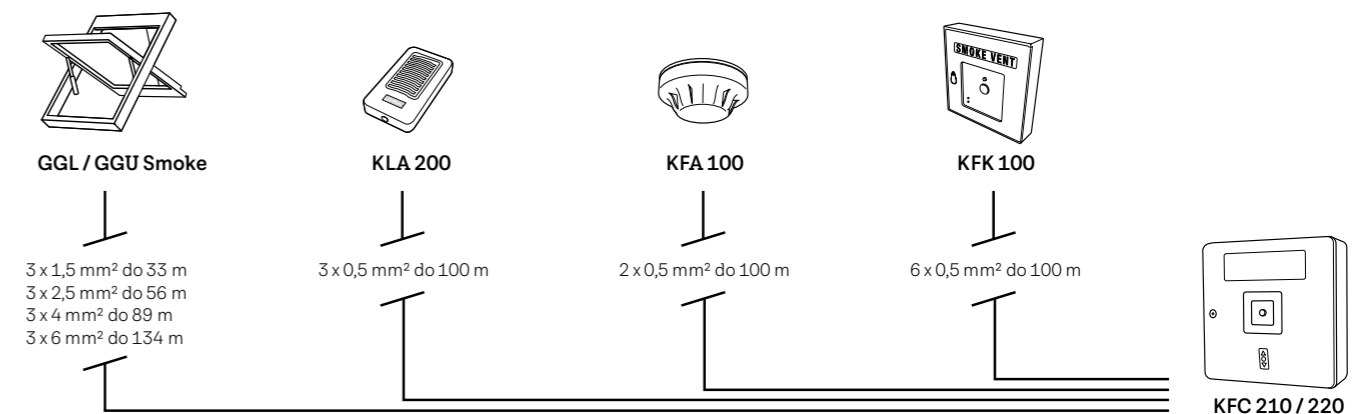

#### Dijagram ožičenja – za ravni krov

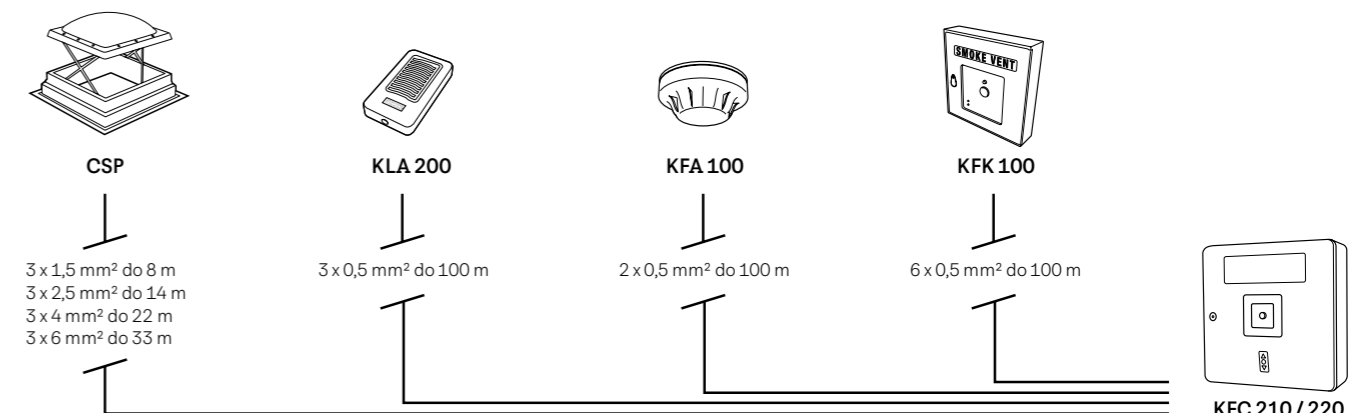



Sve cijene u katalogu su izražene u EUR i preporučene su maloprodajne cijene. Stopa PDV-a je 25 %. Navedene cijene su okvirne i ne predstavljaju ponudu za sklapanje kupoprodajnog ugovora. Stvarnu prodajnu cijenu provjerite sa svojim prodavateljem ili majstorom.

Detaljne odredbe i uvjete VELUX jamstva možete pronaći na [www.velux.hr/jamstvo](http://www.velux.hr/jamstvo).

VELUX ne odgovara za pogreške u katalogima, brošurama i drugim tiskanim materijalima. VELUX zadržava pravo izmjene svojih proizvoda i cijena bez prethodne obavijesti. Aktualne cijene dostupne su na [www.velux.hr/brosure](http://www.velux.hr/brosure).

Sve specifikacije proizvoda, izjave, informacije i podaci (zajedničkim nazivom "Informacije") u ovoj brošuri podložni su mogućim promjenama. Kupac je odgovoran za provjeru i potvrdu podataka u trenutku slanja narudžbe. Vjeruje se da su sve informacije točne i pouzdane, ali su prezentirane bez jamstva ili odgovornosti bilo koje vrste. Za potvrdu informacija provjerite podatke na [velux.hr](http://velux.hr) ili kontaktirajte VELUX službu za korisnike.

VELUX Hrvatska d.o.o.  
Av. V. Holjevca 40  
HR-10010 Zagreb

Besplatni tel. 0800 600 400

Email: [velux-hr@velux.com](mailto:velux-hr@velux.com)  
Web stranica: [www.velux.hr](http://www.velux.hr)

[facebook.com/velux.hr](https://facebook.com/velux.hr)  
[youtube.com/veluxhrvatska](https://youtube.com/veluxhrvatska)

