

**VELUX®**

# **Installers' handbook**

Fifth edition

## Foreword

---

The purpose of this handbook is to provide an overview of the installation of VELUX roof windows and associated products based on best practice principles.

The handbook describes the various aspects of roof construction in association with VELUX products and also provides advice and information on how to obtain the optimum installation.

In addition, the book provides examples of the numerous applications of VELUX products and an overview of the wide range of products and installation possibilities offered by VELUX Company Ltd.

(Fifth edition, December 2015)

### VELUX roof windows and ancillary products

1 2 3 4 5 6 7 8

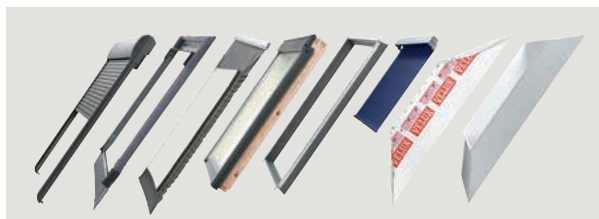

### Other VELUX products for sloping roofs

9



### VELUX products for flat roofs

10

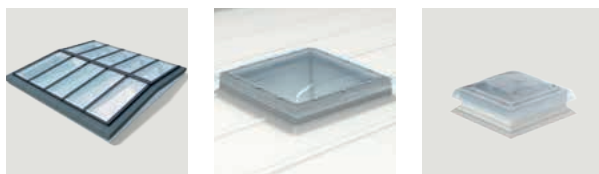

## Contents

---

### Planning

Considerations before choosing a roof window 5-13 1

### Installation of a roof window

Installation step by step 15-27 2

### Flashings

Installation possibilities 29-55 3

### Special installation conditions

Installation in various roof constructions 57-73 4

### Special roofing materials

Installation in various roofing materials 75-101 5

### Replacement / Renovation

Replacement of a roof window 103-113 6

### Building physics

Roof constructions (humidity, heat, sound etc) 115-135 7

### Product information

Overview of VELUX products 137-161 8

### Other products

Other VELUX products for sloping roofs 163-167 9

### Other products

VELUX products for flat roofs 169-175 10

### Contact VELUX Company Ltd

176-177

### List of telephone numbers

178-179

### Size charts

180-181

# Planning

---

1

---

**The construction of the building** 6-7

---

**User requirements** 8

---

**Building regulations** 9-13

---

# Planning

## The construction of the building

To choose the right VELUX roof window for a given situation, you start from the construction of the building, user requirements and current building regulations.

Normally, a standard VELUX roof window can satisfy the basic requirements, but often choosing another window type or variant and/or choosing accessories can optimise the function and increase the utility value of the roof window.

Planning must include the following aspects:

The distance between the rafters in the roof construction usually decides the size of the roof windows if cutting them and installing trimmers is not an option. Therefore, first check whether the position chosen and the size of the roof windows fit into the existing roof construction or if rafters will need cutting (see pages 16, 58).

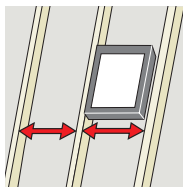

The roof pitch is important when choosing windows and flashings. As a rule, VELUX products can be used in roof pitches from 15° to 90°. However, there are exceptions so always check whether the products chosen can be used in the roof pitch in question (see chapter 8).



The roofing material decides the type of flashing to be installed around the roof window to ensure a watertight installation. The different flashing types are described in chapter 3.

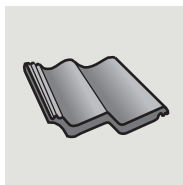

When there is underfelt in the roof construction, a tight connection must be established between the underfelt and the window frame to keep out water, draught and drifting snow. The easiest solution is VELUX underfelt collar BFX (see page 150).

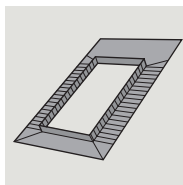

# Planning

## The construction of the building

When the roof window is installed, insulation must be provided around the frame to allow for continuity of the insulation level in the roof. The easiest and most effective solution is VELUX frame insulation collar BDX (see page 150).

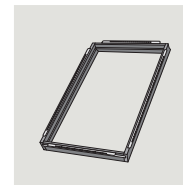

It is essential that the vapour barrier in the roof construction is connected to the roof window. The easy and effective answer is VELUX vapour barrier collar BBX. This will also provide an airtight connection between the roof window and the roof construction (see page 151).

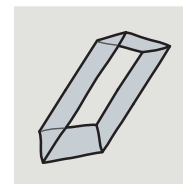

A connection must be established from the window frame to the interior ceiling finish either in the same materials as the interior ceiling finish or by installing a VELUX lining (see pages 152-153).

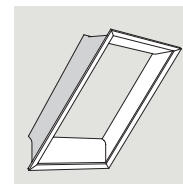

In some environments, such as rooms with high levels of humidity, there are special requirements for the roof window. The correct choice in these cases would be VELUX polyurethane windows (see page 141).

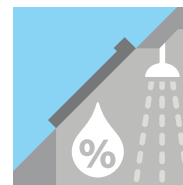

VELUX Company Ltd recommends insulating glass units with laminated glass on the inside for roof windows installed at a high level. In case of breakage, the lamination holds fragments together (see pages 158-161).

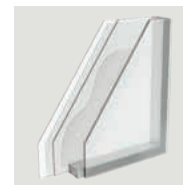

If extra protection against solar heat is needed, VELUX products with particularly good heat reducing qualities are available. For instance, VELUX insulating glass units and VELUX interior and exterior sunscreening products offer these features (see pages 156-157).



# Planning

## User requirements

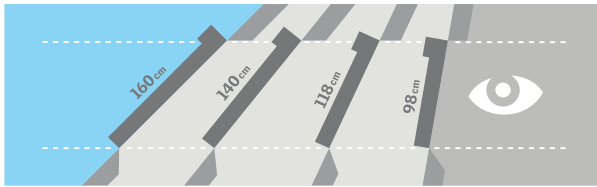

For roof windows placed within reach, try to allow for a clear view when standing and when seated. Note that the optimum window height depends on the roof pitch.

Centre-pivot roof windows make it possible to place furniture directly below the window without obstructing operation of the window.



Top-hung roof windows make it possible to stand upright under the open window while looking to the sides, providing extra head-room and maximising the feeling of extra space. These windows are also suitable for emergency escape/access purposes.



If the roof window is placed out of reach, consider electrical operation, which makes it possible to operate the window as well as interior and exterior sunscreening products from for instance a control pad.



# Planning

## Building regulations

### MEANS OF ESCAPE

If specified for emergency escape purposes, the roof window must have an unobstructed opening of not less than  $0.33 \text{ m}^2$ , with neither the width nor the height less than 450 mm.

The sketch below shows the position of the roof window within the roof slope.

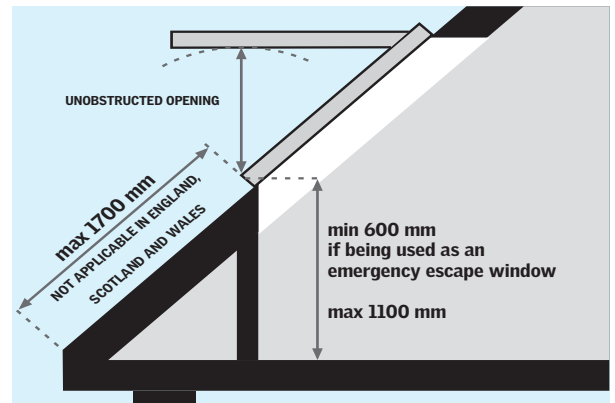

Further details on roof window types and sizes that meet the requirements for emergency escape can be found at [www.velux.co.uk/professionals/installers/products](http://www.velux.co.uk/professionals/installers/products).

### MIMIMUM SILL HEIGHT REQUIREMENTS

The bottom frame of an operable roof window must be positioned at least 0.8 m above floor level.

Restrictor locks could be used for centre-pivot windows with sills below this level.

If the roof window functions as a means of escape, the bottom frame must be positioned as shown on page 9.

### VENTILATION

In habitable rooms, fresh air must be admitted for the health and safety of its occupants. VELUX roof windows provide both purge (rapid) and background ventilation to meet these requirements.

Additional mechanical extraction is required in kitchen and bathrooms etc to rapidly remove large volumes of aqueous vapour.

Building Regulation requirements should therefore be checked as to the correct amount and type of ventilation for a room depending on its size and use.

Individual ventilation areas for the various roof window types can be found at [www.velux.co.uk/professionals/installers/products](http://www.velux.co.uk/professionals/installers/products).



### REQUIREMENTS FOR DAYLIGHT

To provide adequate levels of natural light, we recommend the daylight area of the window be at least 15% of the floor area.

In Scotland every apartment must have a window or windows of an aggregate glazed area equal to at least 1/15th of the floor area of the apartment and must be situated in a roof or external wall.

Individual daylight areas for the various roof window types can be found at [www.velux.co.uk/professionals/installers/products](http://www.velux.co.uk/professionals/installers/products).

### SAFETY GLASS

The Building Regulations state that if glass is less than 800 mm from the floor then insulating glass units with safety glass must be installed. We also recommend that where roof windows are installed at high level, the inner pane be specified as laminated glass. This means that if the glass is broken, the lamination will hold the glass in place preventing it from falling. This is of particular importance within public access areas such as schools, sports centres, conference centres etc.

For optimum performance, we recommend the use of insulating glass variants --60, --62, --66 and --70 (see pages 158-159).

### SOUND INSULATION

To obtain sufficient sound insulation, special requirements may be necessary both in connection with the choice of roof window type and with the installation (see also page 129).

### REQUIREMENTS FOR MAXIMUM ENERGY AND HEAT LOSS

According to building regulations, various requirements apply to the building and the building components in relation to thermal efficiency.

VELUX Company Ltd provides windows and insulating glass units with different levels of thermal insulation (U-value) which allows the appropriate product to be specified and installed in the correct situation. To achieve even better thermal insulation, use VELUX recessed flashing E-J/E-N (see pages 35, 37) in combination with installation set BDx 2000F (see page 150).

U-values for the various roof window types can be found at [www.velux.co.uk/professionals/installers/products](http://www.velux.co.uk/professionals/installers/products).

### REQUIREMENTS FOR SAFETY AT WORK WHEN INSTALLING ROOF WINDOWS AND WORKING AT HEIGHT

Instructions showing the right installation of the product are supplied with any VELUX product. Handling of the product – from delivery to finished installation in the roof – depends on the product type and size and the installation conditions present.

In many cases, VELUX roof windows may be installed from the inside so that working on the roof is avoided.

In some cases it is, however, necessary to carry out part of the installation from the outside, and in these cases it is important to take all necessary protective measures against the risk of falling and dropping items in accordance with the provisions of the Health and Safety at Work Act. Scaffolding or a railing at the base of the roof may be a solution. If work on the roof is brief, fall protection in the form of a safety belt with line/wire should be used.

In addition, heavy and skew lifts while installing VELUX roof windows should be avoided. Appropriate equipment for installing roof windows to reduce or avoid heavy lifts is available. When using suction discs, please note that the window glazing might have a coating that is not compatible to silicone based suction discs which may damage the coating.

Which safety measures to be taken depend on the conditions on the building site and are the full responsibility of the person(s) involved in the work being carried out. The safety measures may be found at [www.hse.gov.uk](http://www.hse.gov.uk).

### SPECIAL ASPECTS

#### Replacement of windows

In some areas, replacement windows come under the aspect of the Building Regulations. This means that application must be made to the Local Authorities before the work can commence.

FENSA and CERTAS registered companies can however carry out replacement work immediately and then register the work with the Local Authorities on completion.

In all cases, local planning and building regulation requirements must be observed.

<b>Preparing opening</b>	<b>16-17</b>
<b>Preparing roof window</b>	<b>18</b>
<b>Exterior</b>	<b>19-24</b>
<b>Interior</b>	<b>26-27</b>



## Installation of a roof window

### Preparing opening

#### POSITIONING THE ROOF WINDOW IN THE ROOM

Position the roof window in the room considering:

- the use of the room
- a clear view when standing and/or when seated
- comfortable operation (centre-pivot or top-hung roof window)
- requirements regarding sill height, see chapter 1
- vertical wall, if any, see page 69
- optimum design of linings
- building regulation requirements



#### HOLE IN THE ROOF

First consult the installation instructions supplied with the flashing. If there is no access to the roof from the outside, establish a hole in the roof surface by cutting a small hole, approx 400 x 400 mm, from the inside through the roof construction. When battens have been cleared, the final position of the window in the roof construction can be determined. When measuring, be sure to allow space for insulation around the window frame.

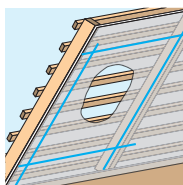

#### POSITION OF TOP, BOTTOM AND SIDE TRIMMERS

See chapter 4.

#### POSITIONING THE ROOF WINDOW

To minimise need for adjustment of the roofing material, adjust the position of the roof window sideways, if possible. When adjusting sideways, be sure to allow for recommended distance to rafter/trimmer (support) (a) and roofing material (b).

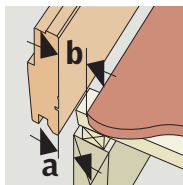

## Installation of a roof window

### Preparing opening

Adjust the position of the roof window upwards/downwards depending on type of flashing. Always read the flashing installation instructions before commencing. In roofs with:

- profiled roofing materials, allow for a full course of tiles below the roof window
- slates, ensure necessary overlap between slates and flashing, see page 95.

To allow for correct insulation around the frame, allow space for 20-30 mm insulation along the sides of the roof window and, depending on the installation level (see page 31), 20 or 50 mm insulation over/under the roof window. Define hole at top and bottom with installation battens and at sides with rafters as shown in the installation instructions.

**Note:** Pay special attention to the positioning of the roof window in the roof in snowy areas, see page 131.

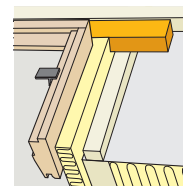
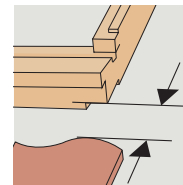

#### HOLE IN UNDERROOF AND INTERIOR CEILING FINISH

Roofing felt can be cut as shown and folded in order to ensure water tightness. If the underroof is rigid, make a hole in the underroof equivalent to the hole in the roof surface.

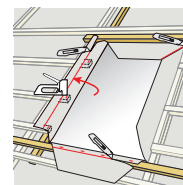

In a roof with an existing interior ceiling finish, it is necessary to cut a temporary rough opening in order to install the roof window. Project frame dimensions perpendicular to the ceiling finish, mark and cut hole.

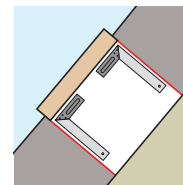

Note that it must be possible to connect the vapour barrier within the existing roof construction (if present) with the new vapour barrier around the roof window.

The final adjustments of the hole in the ceiling finish should not be made until kit for lining or lining is to be installed, see chapter 7.

## Installation of a roof window

### Preparing roof window

#### REMOVING SASH

The sash can be removed to facilitate the installation of the roof window.

Place the sash with top of sash downwards on a clean and even surface.

Scan the QR code to see an animation of how to remove the sash.

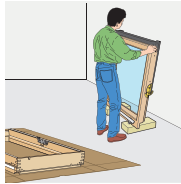

#### INSTALLATION BRACKETS

As standard, installation brackets are supplied with the roof window.

Window heights from 1400 mm (-K08) and upwards are supplied with additional installation brackets to be fitted at the middle of the side frames.

The brackets must be fitted to the frame prior to positioning the window in the roof. Note that the positioning of the brackets on the frame depends on the flashing being used.

With some combinations of roof windows and flashings, special brackets are required, for instance:

- Special brackets are supplied with additional window elements GIL and VFE and with flashing EBW.
- When replacing a roof window manufactured before 1999 and maintaining the existing lining, the brackets supplied with flashings EL/EW/ELX are required as the roof window will be in a projected position.

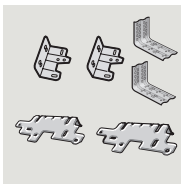
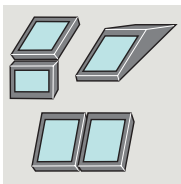
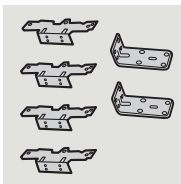
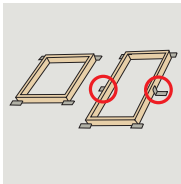

## Installation of a roof window

### Exterior

#### FRAME INSULATION COLLAR

Frame insulation collar BDx consists of four pieces of polyethylene foam fitted on steel rails. Once assembled, the frame is positioned on the battens around the roof opening before installing the roof window. It is then fixed along with the installation brackets of the window.

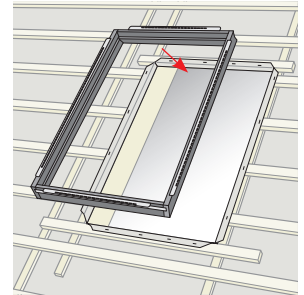
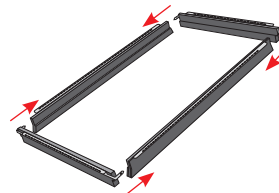

If the distance between the rafters is not sufficient, it may be necessary to adjust the thickness of frame insulation collar to ensure correct positioning by trimming the sides.

The frame insulation collar comes in various versions depending on the installation level of the window. It is available separately or packed together with certain flashings.

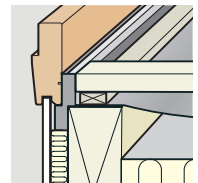
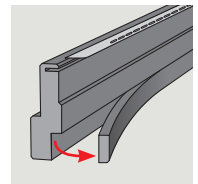

Scan the QR code to see an animation of how to install the frame insulation collar.



## Installation of a roof window

Exterior

### FIXING AND ADJUSTING THE ROOF WINDOW

It is important to adjust the square and level of the roof window to ensure a weathertight seal between the sash and frame and for optimum operation.

Level the bottom frame and fix it at the bottom. Adjust distance between frame and sash to ensure that sides are parallel. Then make sure that bottom frame and bottom sash are also parallel. If uneven rafters cause the frame to twist, adjust frame using the variable thickness support plate supplied as shown in the installation instructions.

If the roof is not level, for instance very lopsided/slanting, see pages 60-61.

Having adjusted the roof window, fix it as described in the installation instructions.

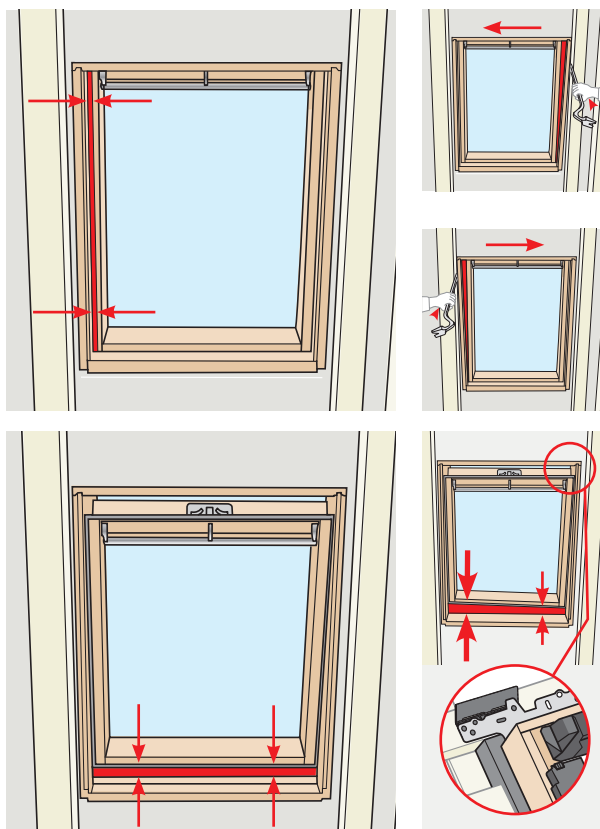

## Installation of a roof window

Exterior

### UNDERFELT

For the easiest connection to underfelt, use underfelt collar BFX. The underfelt collar is made of diffusion open material and can therefore be used for both ventilated and unventilated roof constructions.

The underfelt collar is supplied with a pre-applied adhesive strip, which makes it easy to adhere it to the frame on all sides. Shape the underfelt collar around the battens and fix it to the counter battens with rustproof staples.

Position the drainage gutter immediately above the first continuous batten above the roof window so that it can drain off water from the underfelt above the roof window.

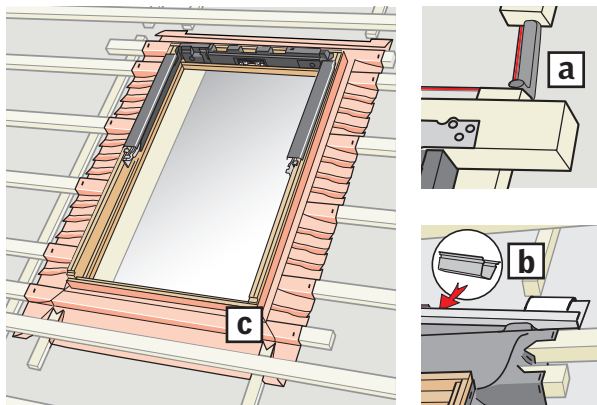

Fit self-adhesive butyl strips supplied as shown (a) to seal the felt where cut over the rafter.

Fold the underfelt collar and then the existing underfelt down into the drainage gutter and fix with brackets supplied (b).

To position and fix the underfelt collar correctly below the roof window, cut underfelt collar as shown (c).

Scan the QR code to see an animation of how to install the underfelt collar.



## Installation of a roof window

Exterior

### FLASHING AND COVERS

As primary weather protection, the roof window is as standard delivered with aluminium covers. Most covers are pre-installed but parts (2) and (4) are supplied with the specified flashing.

- Supplied with the roof window
- Supplied with the flashing

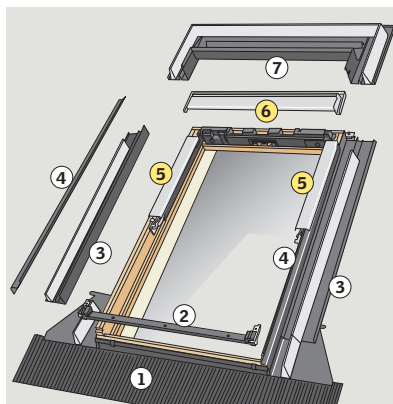

If you do not want to use a VELUX flashing, please note that parts (2) and (4) must be ordered separately. The parts are ordered as cover set ZWC according to the window size.

Fit covers in the sequence indicated in the installation instructions for the flashing. The individual parts have a number on the back that in most cases also indicates the installation sequence. Note that there are left and right parts.

To facilitate the installation, cover parts (5) can be snapped on and off (a). Please note that on high roof windows, parts (4) are fastened by clips in the middle (b).

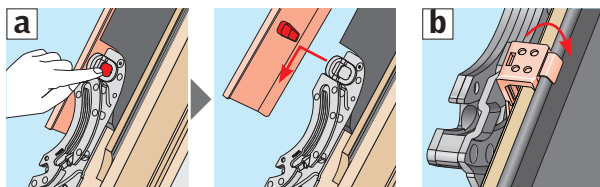

## Installation of a roof window

Exterior

### FLASHINGS FOR PROFILED ROOFING MATERIALS

When installing flashings for profiled roofing materials it is important that both foam gaskets and the flexible part of the bottom flashing section fit tightly to the roofing material to avoid drizzle, drifting snow or driving rain entering under the flashing.

For installations using E-W flashing variants, it is recommended to chamfer the roofing material below the roof window before fitting the bottom flashing section (a).

To ensure optimum installation, position the bottom flashing section temporarily and shape the flexible part to the profile of the roofing material. Remove the flashing and then bend the flexible part (b) slightly before re-positioning and fixing the flashing to the bottom frame of the window. Bending the flexible part ensures a tight connection to the roofing material.

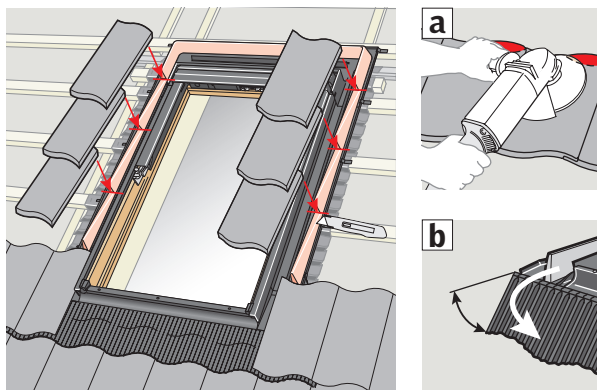

Fold in the bottom side flashing section at the sides (c). Especially in shallow roof pitches, this is important as an extra guarantee against water ingress.

The front edge of the flexible part of the bottom flashing section may be dressed further to fit tightly to the roofing material (d). To allow for correct overlap between roofing material and flashing, it may be necessary to remove a nib from the tile (e).

As screws must not be fitted in the flashing, it may in some cases be necessary to secure tiles with wire and/or adhere to adjoining tile with appropriate sealant if possible (f).

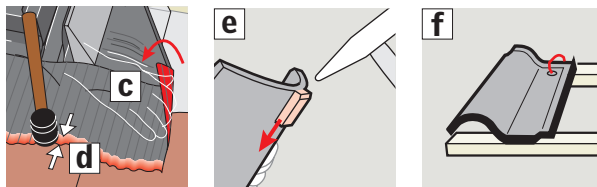

## Installation of a roof window

### Exterior

#### FLASHINGS FOR FLAT ROOFING MATERIALS

When installing flashings in slated roofs or similar roofing materials, it is important that the bottom flashing section overlaps the roofing material with at least the same overlap as applies to the roofing material in general (a). See also page 95.

To provide the best possible drainage around the roof window, observe the distances between roofing material and window stated in the installation instructions (b).

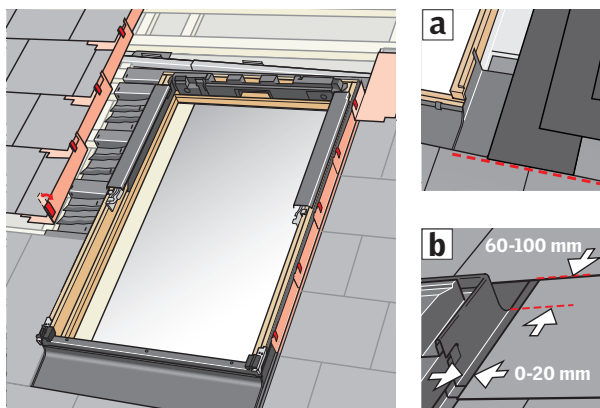

When using flashing E-L, the top flashing section must fit tightly to the window top cover. As the top flashing section follows the slate course, it will in some situations be lifted too much. In these situations, the filler piece supplied must be used to fill the gap.

The same problem might occur when installing in roofs with roofing felt where numerous layers of felt can lift the top flashing section. Here too, it is important to use the filler piece to ensure a tight connection. See also page 76.

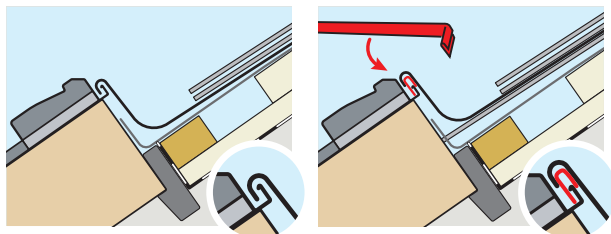

## Installation of a roof window

### Interior

#### CUTTING THE INTERIOR CEILING FINISH

When the roof window has been installed, adjust the hole in the interior ceiling finish to its final dimensions. If using a VELUX lining LS-, adjust the hole by means of the template supplied with the lining. Use of the template ensures horizontal lining at the top and vertical lining at the bottom in roof pitch 30°-60°.

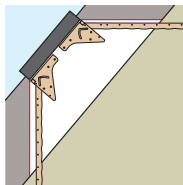

#### ELECTRICAL OPERATION

Before fitting the interior lining finish to manually operated roof windows, it is recommended to provide a cable to prepare for subsequent installation of electrical products.

Run the cable through the pre-drilled hole in the top frame. Fasten approx 20 cm of the cable as shown. The rest of the cable can now be led concealed to a position suitable for subsequent connection to a control unit. For cables up to 40 m, use a cable with dimensions 2 x 1.5 mm<sup>2</sup>, see also page 154.

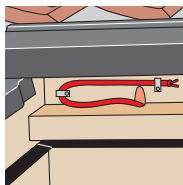
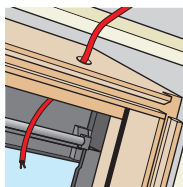

#### INSULATION AROUND THE ROOF WINDOW

Correct insulation around the roof window is important to avoid thermal bridges. Installation set BDX 2000 ensures that the necessary insulation is provided.

If the installation set is not used, provide corresponding insulation around the frame up to the upper side of battens.

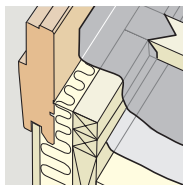
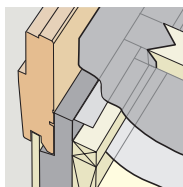

## Installation of a roof window

### Interior

#### VAPOUR BARRIER

The vapour barrier of the house must be connected to the window rebate on the frame using a vapour resistant membrane. VELUX vapour barrier collar BBX is the easiest solution, which ensures an airtight seal between the roof window and the roof structure.

The vapour barrier collar is pressed into the window frame rebate and fastened with screws in the corners. Ensure by means of the tool supplied that the gasket of the vapour barrier collar fits tightly to the roof window. The vapour barrier collar is connected to the vapour barrier of the house by means of the vapour-proof tape supplied.

It is necessary to ensure tight sealed joint between the vapour barrier of the house and the vapour barrier collar.

In any case, the joint should be supported.

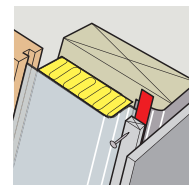
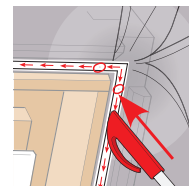
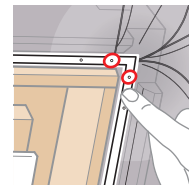

#### LINING

When establishing the lining between the window frame and the interior ceiling finish, try if possible to make the lining horizontal at the top and vertical at the bottom. This gives the best warm air circulation across the inner pane surface, the best influx of light and the best view.

When using VELUX lining LS-, the lining is assembled before being clicked into the rebate in one piece.

If the lining is made of for instance plasterboard, a support frame for the lining may be required. VELUX kit for lining LSG can be used as a support frame.

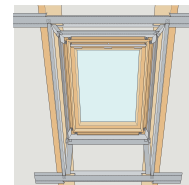
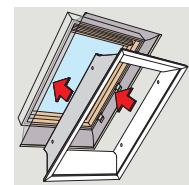

Scan the QR code to see an animation of how to install the kit for lining.

---

<b>In general</b>	<b>30-32</b>
<b>Flashing types</b>	<b>33-39</b>
<b>Combi flashing</b>	<b>40-42</b>
<b>Twin flashing EB-</b>	<b>43</b>
<b>Installation with support rafters EBY / EKY</b>	<b>44-45</b>
<b>Vertical window elements</b>	<b>46-48</b>
<b>Installation with adjustable support rafter EBY W10</b>	<b>49</b>
<b>Additional elements below roof window</b>	<b>50-52</b>
<b>Installation along roof ridge</b>	<b>54-55</b>

## Flashings

### In general

#### THE FLASHING SYSTEM

VELUX flashing systems ensure a safe and secure connection between the roof window and the roofing material.

The wide range of different types of VELUX flashings ensures that tested standard solutions are available for most roofing materials and installation situations.

To be able to choose the right flashing, you must know the type of roofing material, the number of roof windows and the types and sizes of the roof windows to be installed.

The choice of flashing is of decisive importance to the installation as the instructions supplied with the flashing describe how to install the roof windows.

**Therefore, always start by reading the instructions supplied with the flashing.**

When special or additional parts are needed for particular installation situations, these parts will be supplied with the flashing.

Like the roofing material, the flashings drain off water resulting from normal weather conditions. The flashings are not 'submarine tight' and therefore it must be ensured that water cannot accumulate around the roof window. If there is a risk of water accumulation, particular measures must be taken as to the window and the roof.



## Flashings

### In general

#### INSTALLATION LEVELS

The roof windows have been prepared for two installation levels. The two levels are indicated on the side frame as a red line and a blue line; in the following pages, they are referred to as "red level" ■ (standard installation) and "blue level" ■ (recessed installation), respectively.

To ensure the correct positioning of installation brackets and frame in the roof, it is important to confirm that the flashing has been designed for the relevant installation level.

##### Red level

VELUX standard since 1999.

Installation brackets are fixed to the bottom and top frames.

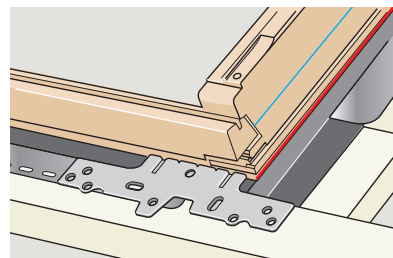

##### Blue level

Roof window installed 40 mm deeper into the roof construction compared to installations in red level.

Installation brackets are fixed to the side frames.

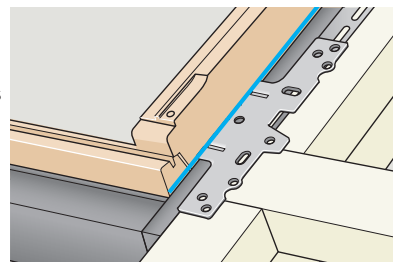

When replacing a roof window manufactured before 1999 and maintaining the existing lining, the window will be in a projected position. This requires particular flashings and installation brackets. See chapter 6.

Installation brackets are supplied with the flashing and must be fixed to the side frames.

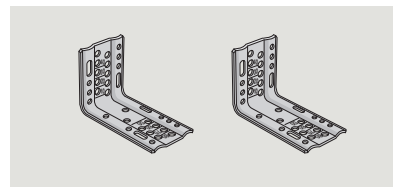



# Flashings

## In general

### TYPE DESIGNATION FOR FLASHINGS

The type designation for flashings consists of three characters.

The first letter in the type designation is always an **E--**.

The second letter in the type designation refers to the installation situation, for instance:

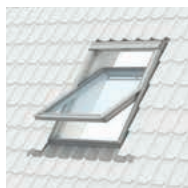

**ED-**  
Single flashing

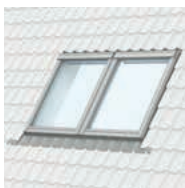

**EB-**  
Twin flashing



**EK-**  
Combi flashing



**EF-**  
Flashing for vertical window element

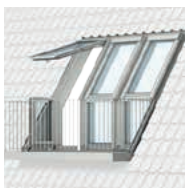

**EE-**  
Flashing for roof terrace



**ET-**  
Flashing for additional element

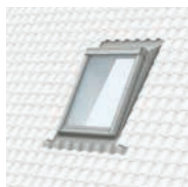

**EA-**  
Kerb flashing for pitched roofs

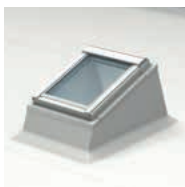

**ECX**  
Flat roof kerb



**EKX --88**  
Roof ridge kit

The third letter in the type designation indicates the types of roofing material in which the flashing can be installed. On the following pages, the various flashing types are introduced, shown as single flashings.

Please note that profile height of the roofing material and roof pitch will influence the choice of flashing.

# Flashings

## Flashing types

### EDW ■

For profiled or flat roofing materials with a profile height/thickness of 15-120 mm.

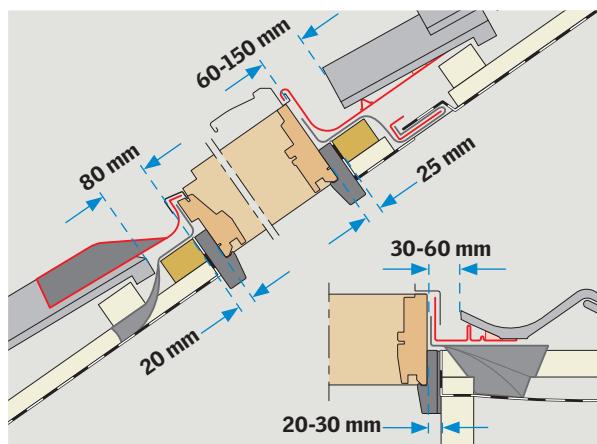
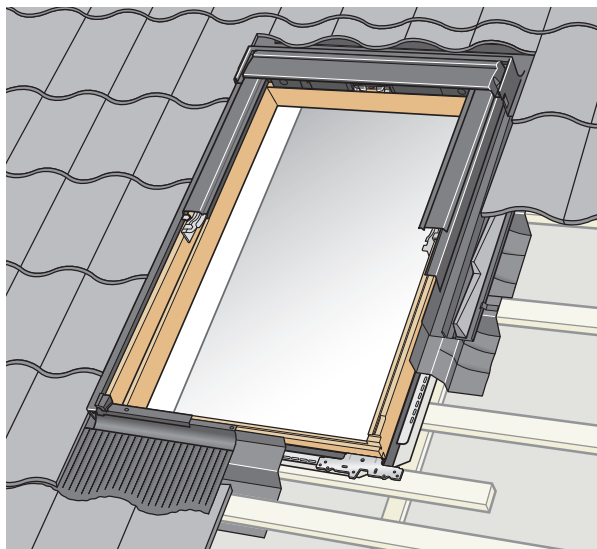
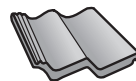
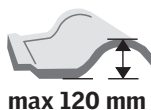

## Flashings

### Flashing types

#### EDZ ■

For profiled or flat roofing materials with a profile height/thickness up to 45 mm.

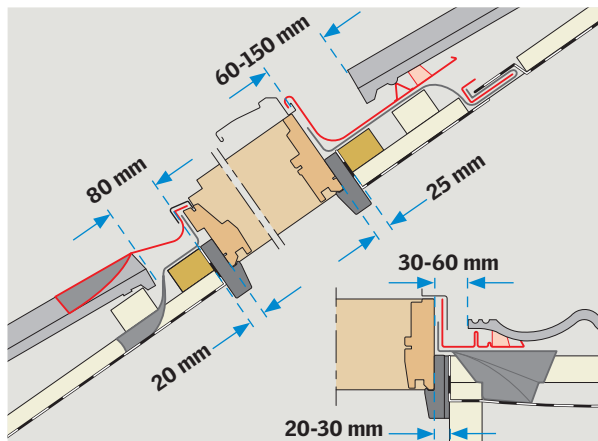
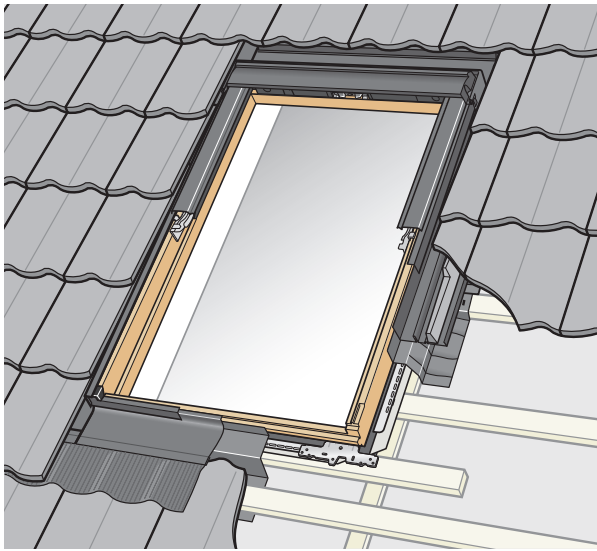
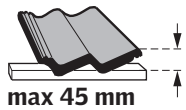

## Flashings

### Flashing types

#### EDJ ■

In principle as EDW, but with roof window installed 40 mm recessed into the roof construction (blue level).

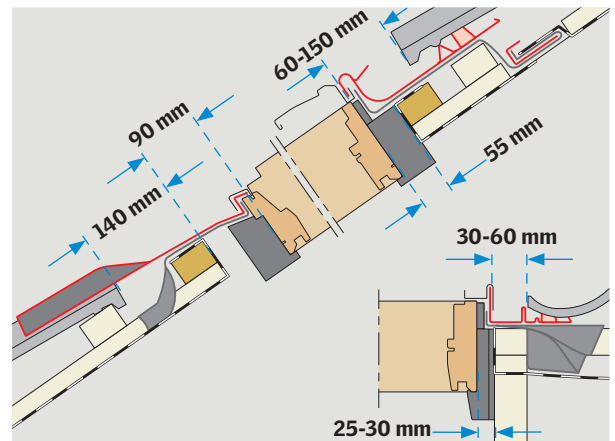
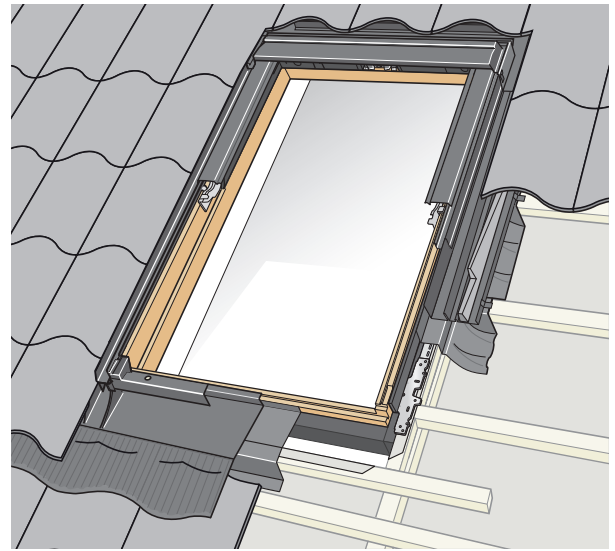
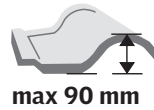

## Flashings

### Flashing types

#### EDL ■

For flat roofing materials with a thickness of up to 2 x 8 mm. With side soakers.

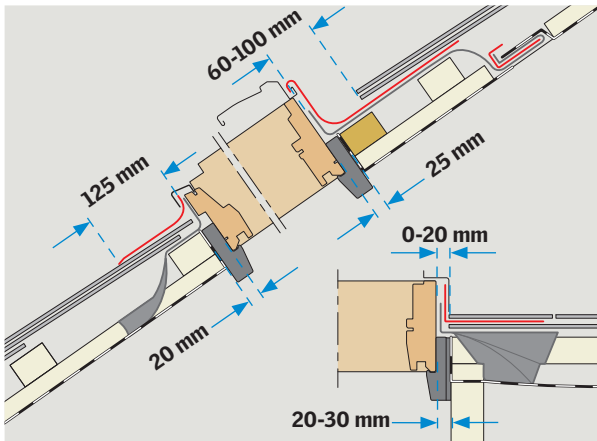
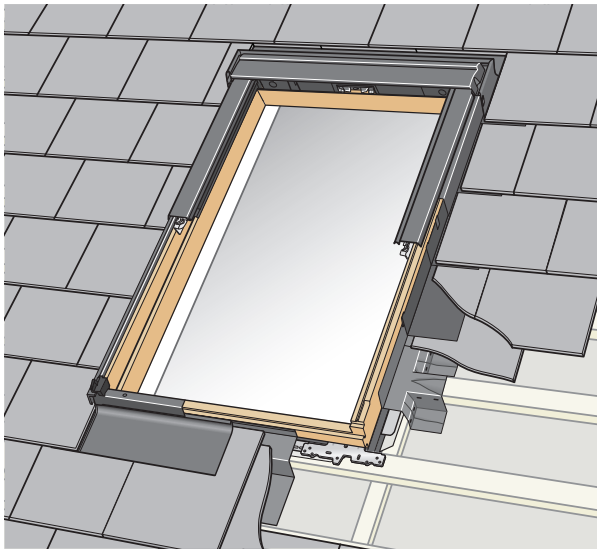
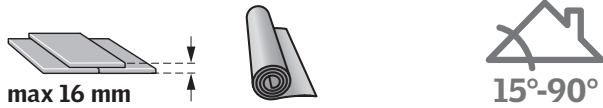

## Flashings

### Flashing types

#### EDN ■

In principle as EDL, but with roof window installed 40 mm recessed into the roof construction (blue level).

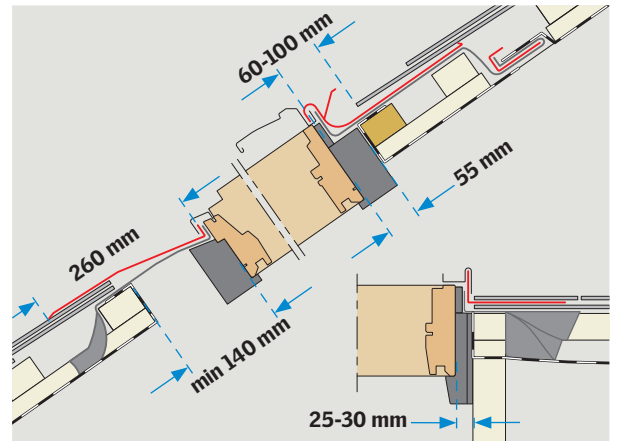
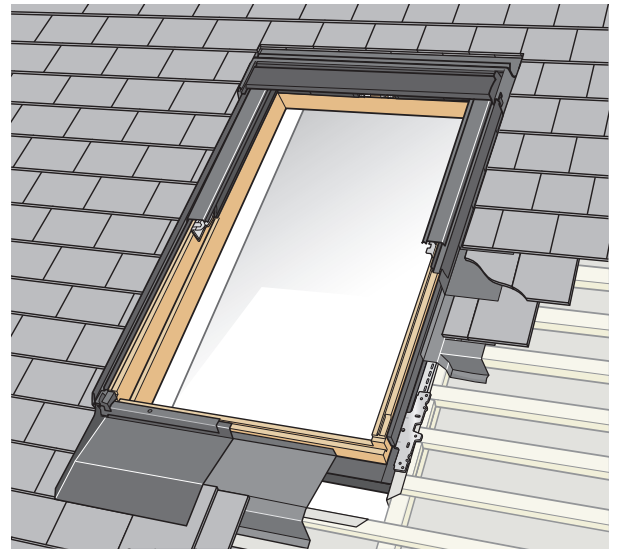

## Flashings

### Flashing types

#### EDP ■

For roofs with plain tiles/tuile plate.

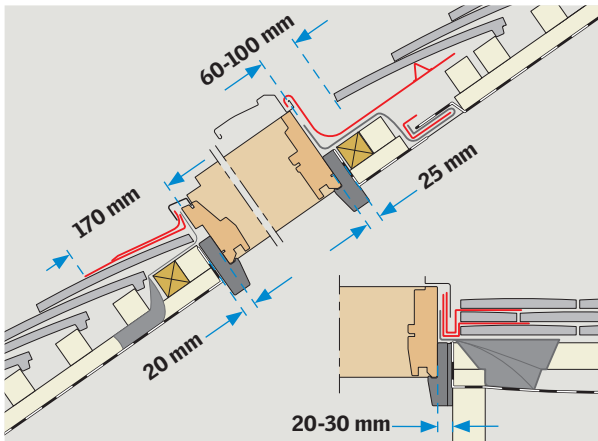
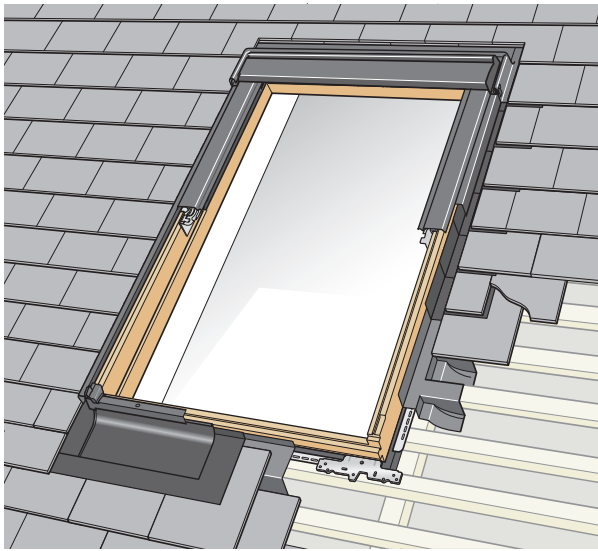
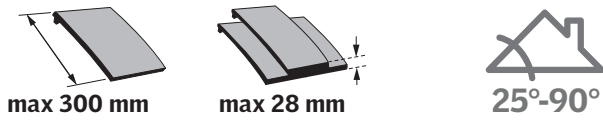

## Flashings

### Flashing types

#### EDE ■

For installation in traditional standing seam roofs in copper or zinc.

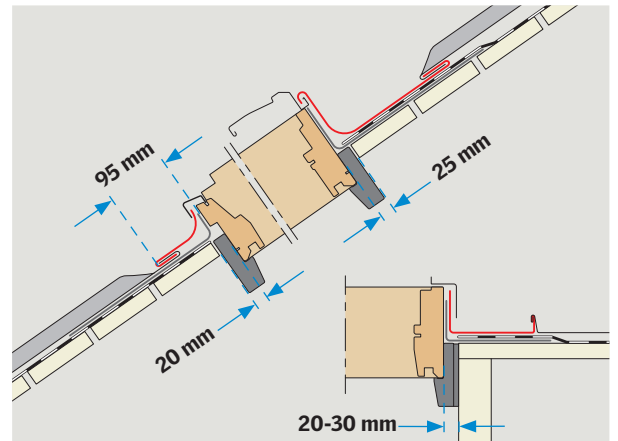
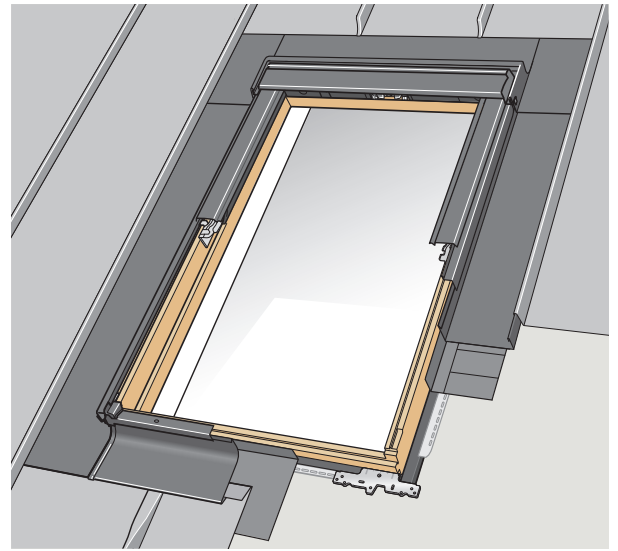
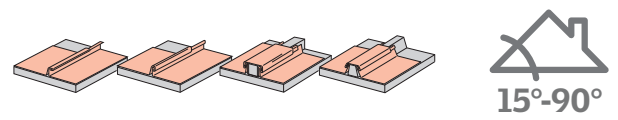

# Flashings

## Combi flashing

In general, a single flashing consists of a bottom flashing section (1), side sections (2) and a top flashing section (3).

Basically, the same components are used when combining roof windows. They are, however, supplemented with components that ensure the rainwater is drained quickly and freely from around the roof windows.

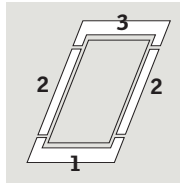

There are two drainage principles:

### LOW-LYING MIDDLE GUTTERS

Flashings with low-lying middle gutters drain off the water from the roof surface above the roof windows down the outer sides of the windows and the centre channel between them.

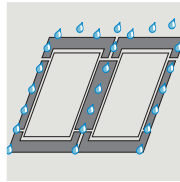

This drainage principle makes it possible to combine an unlimited number of windows on the roof surface.

The principle is used for the combi flashing system.

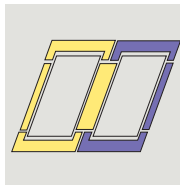

### HIGH-LYING MIDDLE GUTTERS

Flashings with high-lying middle gutters drain off the water from the roof surface above the roof windows down the outer sides of the window combination only.

This drainage principle makes it possible to install the windows closer to each other compared to the combi flashing system.

The principle is used for instance for twin flashing EB-.

The total width of a combination (window widths + frame distances between side frames) with high-lying middle gutters must not, however, exceed 2780 mm.

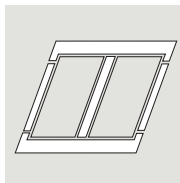
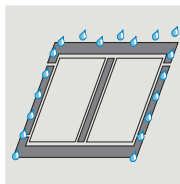

# Flashings

## Combi flashing

The combi flashing system consists of six basic elements that make it possible to install from two to any number of roof windows in combinations side by side or over/under each other. Windows to be installed side by side must be of the same height and windows to be installed over/under each other must be of the same width.

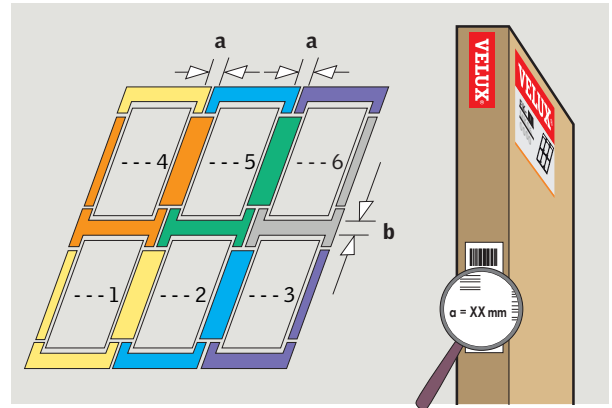

The six basic elements have numbers referring to the last number in the variant code of the flashing. Thus, EKW MK08 0002 is the middle flashing element in the bottom row.

Distance "a" refers to the distance between the side frames whereas distance "b" refers to the distance between top and bottom frames.

Distance "a" is as standard 100 mm, but can also be 120, 140 and 160 mm. In addition, combi flashings can be ordered as special products with "a" distances from 60 to 400 mm, at intervals of 10 mm. Distance "b" can only be 100 or 250 mm.

To allow for subsequent installation of a roller shutter on the roof window, distance "a" must be min 100 mm and "b" must be 250 mm.

The distances must be stated when ordering the flashing. They will appear from the flashing packaging for confirmation.

**Note:** If "a" is less than 100 mm, the roof windows must be installed with special installation brackets supplied with the flashing. Otherwise the brackets supplied with the roof window should be used.

## Flashings

### Combi flashing

#### ROOF WINDOWS INSTALLED OVER/UNDER EACH OTHER

Combi element 7 is used when installing any number of roof windows over/under each other. Always use a single flashing for the bottom window supplemented with combi element 7.

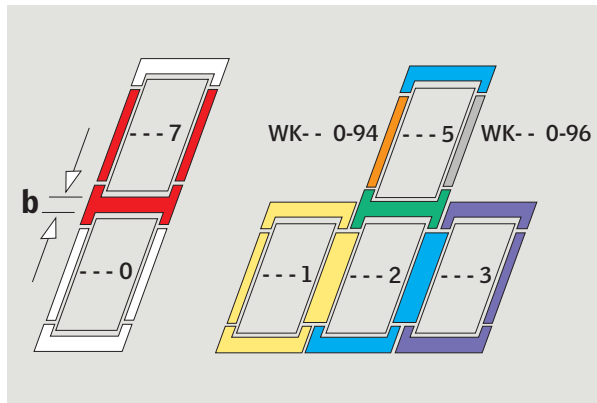

#### ASYMMETRICAL INTEGRATION

By using asymmetrical flashing elements, roof windows can be installed in a combination with more windows in the bottom than in the top rows.

The asymmetrical flashing elements are used in the combi system as a substitute for the "missing" windows. For instance flashing EK- WK-- 0-94 is used instead of combi element 4.

Combinations with less windows in the bottom rows are possible. In flat roofing materials, flashing EKL should be used whereas flashing EKW should be used in profiled roofing materials. These combinations must be ordered as special products; contact VELUX Company Ltd.

## Flashings

### Twin flashing EB-

Twin flashing EB- is used when installing two roof windows of the same height side by side when a minimum frame distance is required.

As standard the two roof windows are installed with a frame distance "a" of 18 mm or 50 mm. Frame distances of between 19 and 100 mm are possible but the flashing must be ordered as a special product.

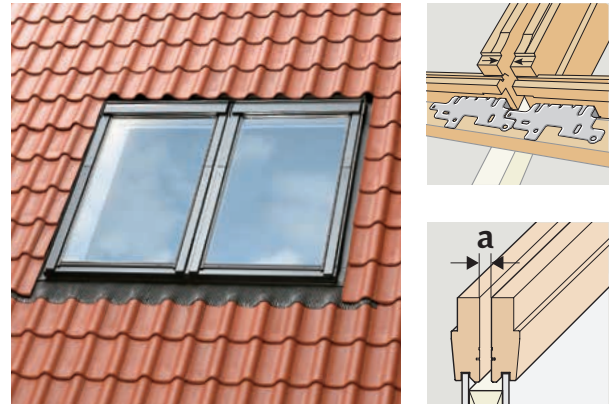

The high-lying middle gutter makes it possible to install the windows close together. If the gap between the windows does not allow for the provision of a standard rafter, a support timber with a width no greater than distance "a" + 25 mm must be provided between the two windows to support them along their length.

If the distance "a" is 18 mm, we advise using VELUX support rafter EBY.

Follow the instructions supplied with flashing EB- when installing the roof windows.

Additional window installation brackets are supplied with the flashing.

## Flashings

### Installation with support rafters EB/EKY

Use support rafters EB/EKY to obtain a harmonious room side finish when two roof windows are installed side by side with a frame distance of 18 mm (EBY) or 100 mm (EKY). When using these support rafters, upper and lower trimmers must be installed to support the construction, see chapter 4.

Support rafters EB/EKY are available in three different lengths: 2000 mm (W20), 2750 mm (W27) and 3500 mm (W35).

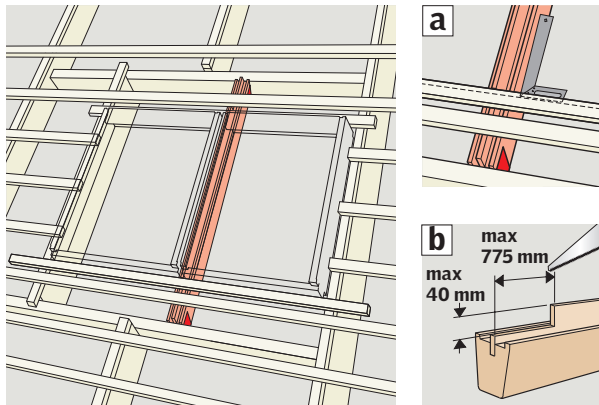

Follow the installation instructions supplied with the flashing when installing the roof windows. Adjustment of the window, however, is described in the installation instructions for the window.

When establishing the roof aperture and positioning trimmers and support rafter, it is important that the support rafter is positioned perpendicularly to the installation battens (a).

Observe the maximum dimensions stated when cutting the support rafter in order to avoid weakening it unnecessarily (b).

If installation set BDX 2000 is used, the frame insulation collar must be assembled and installed before the roof windows are installed.

### SUPPORT RAFTER EB/EKY ONLY

Four installation brackets used for securing the roof windows to the rafter are supplied with the flashing.

Connect underfelt as if connecting around one roof window. Position the drainage gutter as close as possible to the installation batten above. Then proceed according to the instructions supplied with flashing EB-.

## Flashings

### Installation with support rafters EB/EKY

#### INSTALLATION POSSIBILITIES

When the proper conditions exist, the length and load capacity of a support rafter increases the possibilities for installing more than two roof windows.

A specific solution therefore depends on the combination of the factors below.

- Size of roof windows (width (X) x height (Y))
- Type of roof windows (affects the weight)
- Distance between trimmers (L)
- Total height of roof windows (H)
- Distance from roof windows to trimmers (D1 and D2)
- Climatic zone and ground conditions (location of the building)
- Roof pitch

Once these factors have been determined, you can contact VELUX Company Ltd. Based on your information, they will guide you about the possibilities as to installing additional roof windows.

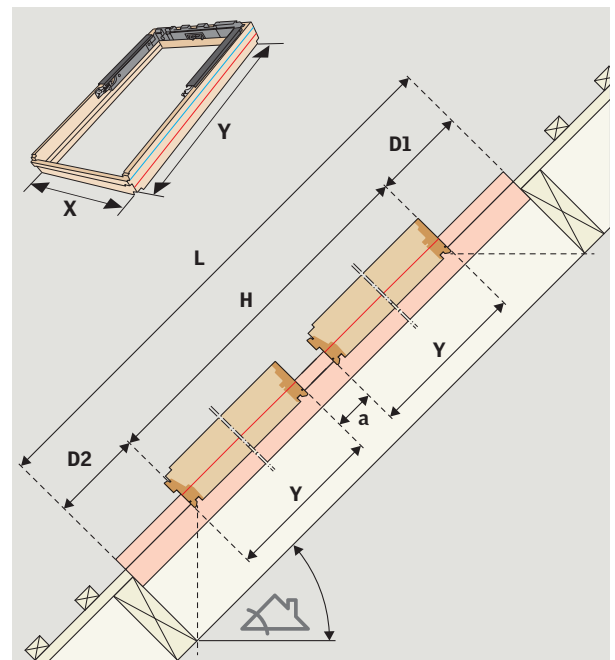

## Flashings

### Vertical window elements

#### VERTICAL WINDOW ELEMENTS VFE/VIU WITH FLASHINGS EFW/EFL/EFN/EFJ

Vertical window elements VFE/VIU are always combined with a roof window of the same width. The flashings for these combinations are EFW/EFL for standard (red) installation level and EFN/EFJ for recessed (blue) installation level.



Follow the instructions supplied with the flashing when installing vertical window elements and roof window.

Additional installation brackets for the roof window are supplied with the vertical window element.

**Note:** When installing vertical window elements, the drainage of the roof must be considered as the course of the eaves gutter is interrupted. As the flashing drains off the water to both sides of the roof windows, it must be ensured that there is a downpipe on both sides of the interrupted gutter.

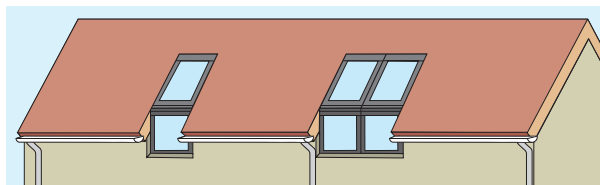

## Flashings

### Vertical window elements

#### POSITION IN FAÇADE

The roof window must be installed before the vertical window element. The template supplied with the vertical window element must be used to determine the exact position of the roof window and the vertical window element respectively. The optimum position of the vertical window element depends on the façade.

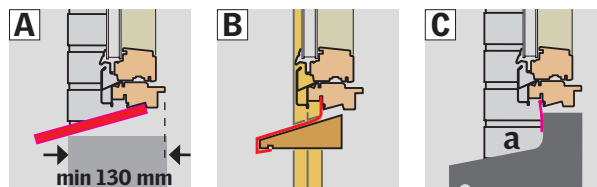

- A** Installation in brick, concrete wall etc: The vertical window elements must be positioned at least 130 mm (VFE) and 160 mm (VIU), respectively, from the façade of the house. This ensures that the top cover of the window element lies behind the façade. It also makes installation of an outer sill easier.
- B** Installation in façade with vertical wooden boarding (with overlap): The vertical window elements VFE/VIU must be positioned so that the outer edge of the side frames is flush with the innermost layer of boarding.
- C** In some cases, it may be necessary or desired to cover the joint between the bottom frame and the outer sill. For this purpose, an additional cover part can be ordered as a special product (a).

#### OUTER SILL AND DRAINAGE OF BOTTOM FRAME

The outer sill can be made in many ways depending on the façade.

It is important that there is a sufficient overlap between the bottom frame and the outer sill (approx 25 mm) to ensure that water from the gasket level of the vertical window element can be drained off.

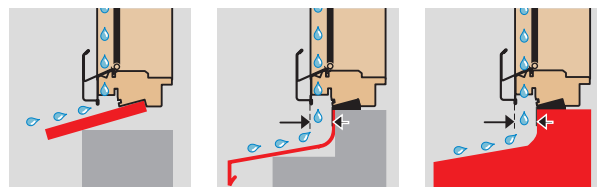



## Flashings

### Vertical window elements

#### VERTICAL WINDOW ELEMENTS VFE/VIU WITH FLASHINGS EFW/EFL/EFN/EFJ XK99

Using flashings EFW/EFL/EFN/EFJ **XK99**, vertical window elements VFE/VIU can be combined with any number of roof windows and vertical window elements.

**Note:** It is not possible to combine VIU with VFE.



The flashing must be ordered as a special product with exact specification of the position of the individual roof windows and vertical window elements. To ensure sufficient drainage of the roof surface above the windows there are some limitations as to possible combinations.

A combination of windows and frame distances (**a**) with a total width of less than 2780 mm will, as a single roof window, drain off the water to both sides of the combination.

Combinations with a total width of more than 2780 mm require drainage between the windows. This is established by inserting a low-lying middle gutter and "box" gutter (**A**) that drains off water separately to a downpipe.

Roof pitch "**x**", frame distances "**a**" and, where necessary, "**b**" must be specified at the time of ordering along with window sizes and combination.

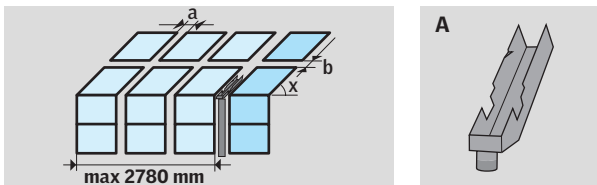

## Flashings

### Installation with adjustable support rafter EBY W10

Adjustable support rafter EBY W10 is recommended for combinations including vertical window elements installed with a frame distance of 18 mm.

Adjustable support rafter EBY W10 can be used in roof pitches from 15° to 55°.

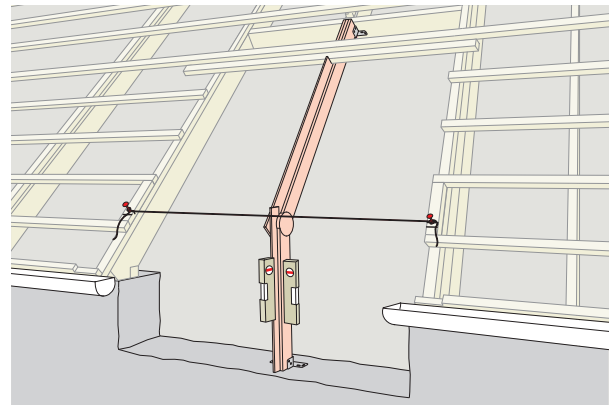

When using this adjustable support rafter, a top trimmer spanning the total width of the aperture is installed in the roof construction. The adjustable support rafter provides the central support to the roof windows and vertical window elements while at the same time ensuring an elegant room side finish to match the windows.

In combinations with additional adjustable support rafters, the total width of the combination must not exceed 2780 mm because of the flashing. For further information, contact VELUX Company Ltd.

## Flashings

### Additional elements below roof window

#### ADDITIONAL ELEMENTS GIL/GIU AND FLASHING EXTENSIONS ETW/ETL/ETN/ETJ

Additional elements GIL/GIU are installed immediately below the roof window.

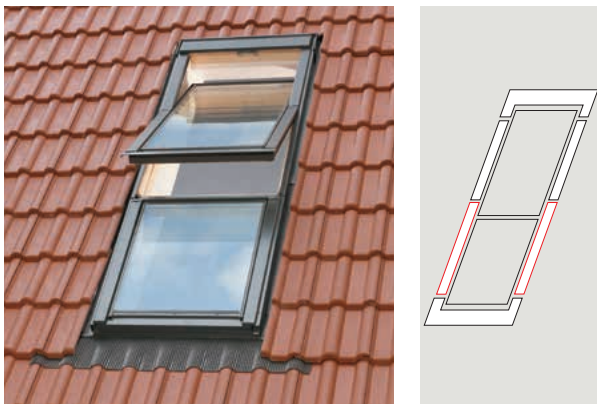

The flashing for this combination is a standard single flashing together with flashing extensions ETW/ETL/ETN/ETJ.

Follow the instructions supplied with additional elements GIL/GIU when installing the combination. Adjustment of the roof window is described in the installation instructions for the window.

The additional element is supplied with additional installation brackets.

Note that the frames of the roof window and the additional element must align to allow for subsequent fitting of linings.

## Flashings

### Additional elements below roof window

#### ADDITIONAL ELEMENTS GIL/GIU IN TWIN INSTALLATION WITH SUPPORT RAFTER EBY

Two roof windows each with additional elements GIL/GIU can be installed with a frame distance of 18 mm using support rafter EBY and a variant of twin flashing EB- (variant EB- -K-- --22BA).

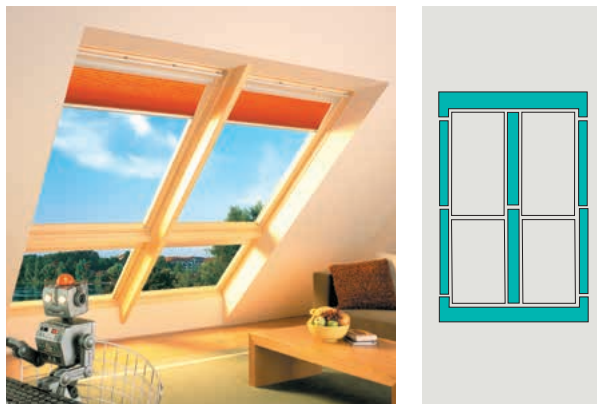

Follow these guidelines during installation:

1. Prepare hole and install necessary trimmers.  
Width:  $X \text{ mm} + 18 \text{ mm} + X \text{ mm} + 60 \text{ mm}$ .  
Height:  $Y \text{ mm} + 920 \text{ mm} + 45 \text{ mm} + \text{distance to trimmers}$ .  
 $X \text{ mm}$  = width of roof window and additional element,  $Y$  = roof window height
2. Install support rafter EBY according to instructions supplied with the support rafter.
3. Install frame insulation collar BDX with extension piece BDX WK34 according to instructions supplied with the extension pieces.
4. Install and adjust roof windows and additional elements.
5. Connect roof windows and additional elements to underfelt with underfelt collar BFX and position drainage gutter as close to the top frame as possible.
6. Install flashing and fit covers according to instructions supplied with the flashing.

It is also possible to integrate three roof windows with additional elements side by side provided that the total width of the window combination with high-lying middle gutters does not exceed 2780 mm.

## Flashings

### Additional elements below roof window

#### ADDITIONAL ELEMENTS GIL/GIU IN COMBI INSTALLATION

Roof windows with additional elements GIL/GIU can also be used in combi installations with flashing extensions ETW/ETL/ETN/ETJ as a supplement to the common combi flashing elements.

For instance, if roof balcony CABRIO® GDL is to be included in a combi installation, additional element GIL must be installed beside the roof balcony with a roof window (height -K10) above. The total length/height of these two windows corresponds to that of the roof balcony. Note: If installing two or more roof balconies CABRIO® GDL side by side, a minimum frame distance of 120 mm is advised.

For a frame distance of 100 mm, use support rafter EKY.

Example: In profiled roofing material, you need a combination of three flashing parts.

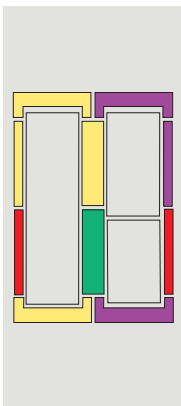

Combi flashing EKW -K10 --00E  
(E = middle gutter for frame distance a = 100 mm)



Flashing extension ETW WK34 --00  
(pair of side sections)



Flashing extension ETW WK34 --00E  
(E = middle gutter for frame distance a = 100 mm)



# Flashings

## Installation along roof ridge

When choosing flashing for installations along the roof ridge, the simplest solution is to use standard single flashings EDW/EDL/EDS on each side of the roof. Depending on distance to ridge, it can also be combined with a roof ridge kit EKX -K-O --88.

Installing windows along the roof ridge opens up to spectacular combinations of VELUX roof windows – seen from the outside as well as from the inside.



The procedure is simple:

The installation itself does not differ much from a standard installation and the same rules as to positioning the roof window in relation to roofing material must be observed.

Therefore, in tiled roofs always try to allow for a full course of tiles below the roof windows.

When installing roof windows along the roof ridge, it is important to know the "ridge measurement". This is the distance from the top frame of the window to upper side of battens on the opposite roof surface. In the following this measurement is defined as "A" mm.

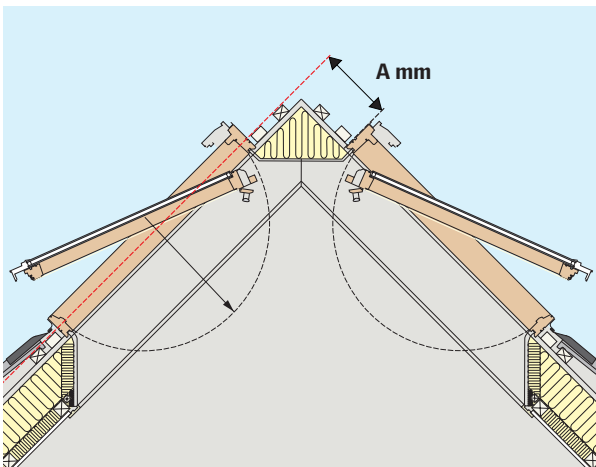

# Flashings

## Installation along roof ridge

When centre-pivot roof windows are installed with the top frames close to the ridge, note that they must be positioned in a way that allows them to be opened without the sashes colliding.

This can be ensured by observing the "A" measurement as stated in the table:

Roof pitch	Window height (mm)				
	780	980	1180	1400	1600
30°	80	80	80	80	100
35°	80	80	90	120	140
40°	90	110	140	170	185
45°	120	160	250	300	330
50°	230	290	340	400	460

In case of roof pitches below 30°, the roof windows can be installed frame-to-frame without risk of sashes colliding ("A" must always be at least 80 mm).

When "A" is between 80 mm and 200 mm, one pair of roof windows either side of the roof ridge requires 1 roof ridge kit EKX -K-O --88 and 2 single flashings ED-. When combining more pairs of roof windows on each side, combi flashings EK- and 1 roof ridge kit for each pair of roof windows along roof ridge are required.

Whether it is one pair or more pairs of roof windows, the top flashing sections must be adjusted according to the distance "A" to the roof ridge. Follow the instructions supplied with the roof ridge kit.

**Note:** Roof ridge kit EKX -K-O --88 requires a ridge board to support the roof ridge (especially in slate roofs).

If distance "A" is 200 mm or more, the standard flashing can be used without any adjustment. There is enough space for the top flashing sections and the ridge tiles can continue uninterrupted.

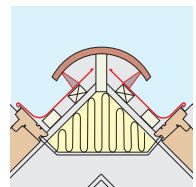
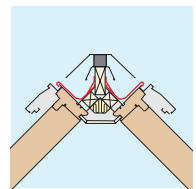

<b>Trimmers</b>	<b>58-59</b>
<b>Installation in lopsided roof</b>	<b>60-61</b>
<b>Connection to rigid underroof</b>	<b>62-63</b>
<b>Cut tiles below the roof window</b>	<b>64-65</b>
<b>Roof window installed as a skylight</b>	<b>66-67</b>
<b>'Dutch barn' type roofs</b>	<b>68</b>
<b>Installation in connection with vertical wall</b>	<b>69</b>
<b>Flat roof</b>	<b>70-71</b>
<b>Atrium in flat roof</b>	<b>72-73</b>

## Special installation conditions

### Trimmers

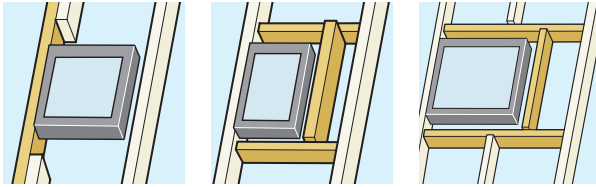

If the roof window is wider than the distance between the rafters, it may be necessary to install trimmers in the rafter construction. In most cases when installing a trimmer to support a single rafter, the solution is based on experience. Most often the trimmer has the same dimensions as the rafters.

**Note:** Some constructions may require static calculations of the load capacity of the new trimmer and remaining rafters.

Special conditions to consider:

- A large roof surface above or below the trimmed opening
- Existing trimmers in the roof construction close to the new trimmed opening
- Possible special support conditions for existing rafters

For combinations of more roof windows side by side, it is often possible to adjust window width and frame distances between the windows in order to retain rafters. This must be determined before ordering flashings.

Recommended distances between window frame and rafter/trimmer to allow for effective insulation around the windows.

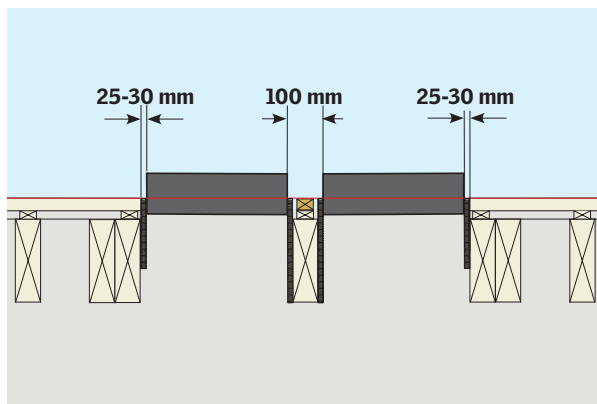

## Special installation conditions

### Trimmers

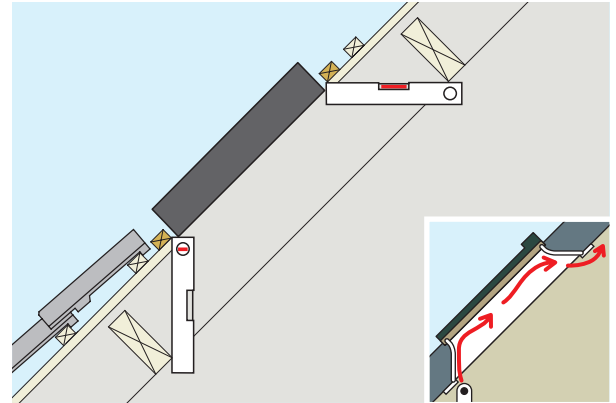

Good air circulation across the inner pane surface minimises the risk of condensation. Circulation is achieved by a horizontal top lining and vertical bottom lining to form a "funnel" leading air across the pane.

If trimmers are necessary, they must be positioned in such a way that they do not obstruct the angled lining. When using VELUX kit for lining LSG or VELUX linings LS- in roof pitches from 30° to 60°, the lining can be made with both horizontal top and vertical bottom.

In roof pitches shallower than 30° or steeper than 60°, the VELUX lining LS- cannot be installed with both horizontal top and vertical bottom as this will result in removing too much of the interior ceiling finish. Instead, the template supplied with the lining can be used to determine the optimum design of the aperture and the correct position of the trimmer.

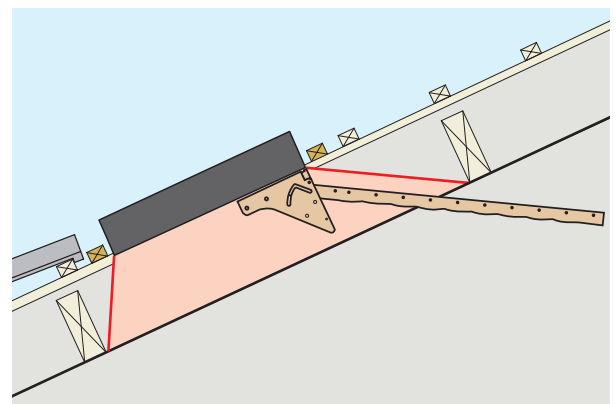

## Special installation conditions

### Installation in lopsided roof

In old buildings with very lopsided roof constructions, it may be necessary to deviate from the standard procedure for adjusting the roof window. The window should still be installed as normal but consideration should be given to alignment with existing floor level or roof.

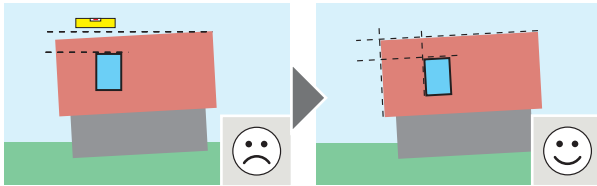

Major local lopsidedness in the roof construction may also complicate adjustment of the roof window.

It may be necessary to elevate one corner of the roof window with more than the height of the variable thickness support plate supplied. In this case, the entire installation batten must be elevated.

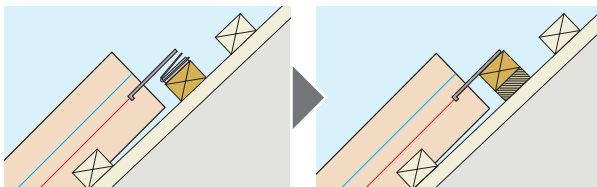
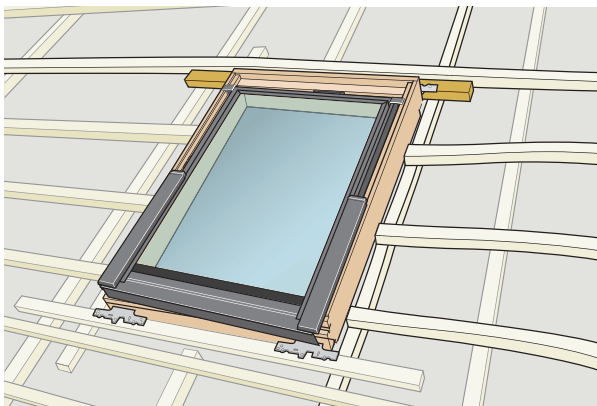

## Special installation conditions

### Installation in lopsided roof

The red line/blue line level of the window will now lie above the upper side of the battens which might result in leakages in the flashing.

For this reason, to avoid leakages and even out the connection between the flashing and the roofing material, it is necessary to "chock up" the battens around the roof window.

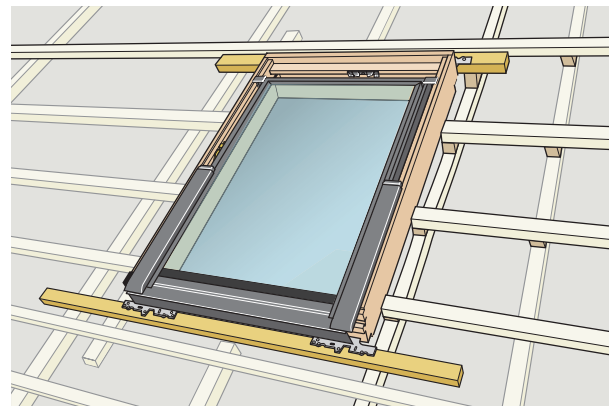
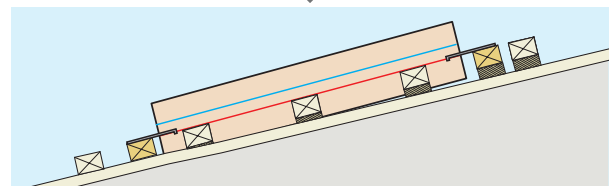
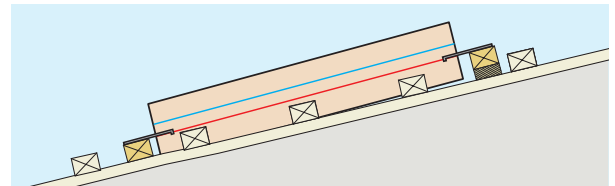

## Special installation conditions

### Connection to rigid underroof

#### UNDERROOF OF MASONITE PLATES

Connection to underroof of masonite plates can be made either with VELUX underfelt collar BFX or with standard underfelt in rolls.

**Note:** If no counter battens have been used in connection with the masonite underroof, it may be necessary to make a "frame" around the roof window to which the underfelt or the underfelt collar can be fixed. The "frame" can be made by placing infill battens between battens along the sides of the roof window. The underfelt or the underfelt collar can then be connected below and along the sides of the roof window as shown.

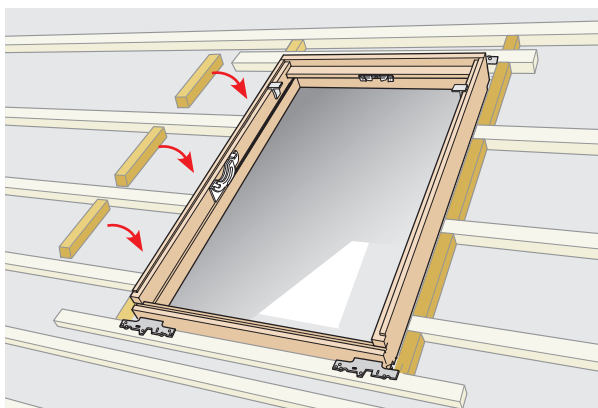

The illustration below shows principle for connection to underfelt.

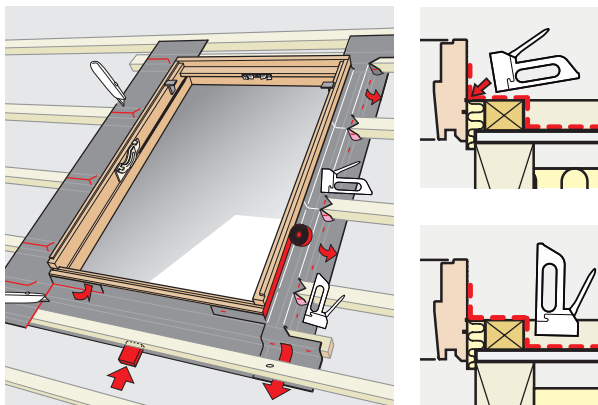

## Special installation conditions

### Connection to rigid underroof

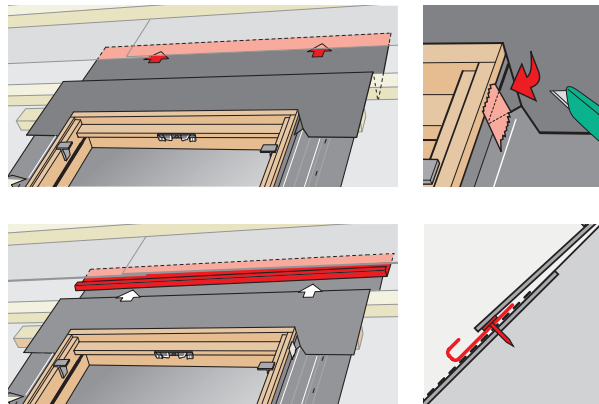

Lay masonite plates by way of overlapping. This makes it easy to interweave the drainage gutter in the nearest overlap above the window.

#### UNDERFELT ON RIGID BASE

Connection to underfelt on rigid base – boards or sarking – can be carried out with VELUX underfelt collar BFX as well as standard underfelt.

**Note:** As in some cases an uninterrupted underfelt is required, ensure sufficient drainage by securing the batten with screws and joint filler as shown. The compressed connection also ensures connection to the underfelt or the underfelt collar BFX above the roof window.

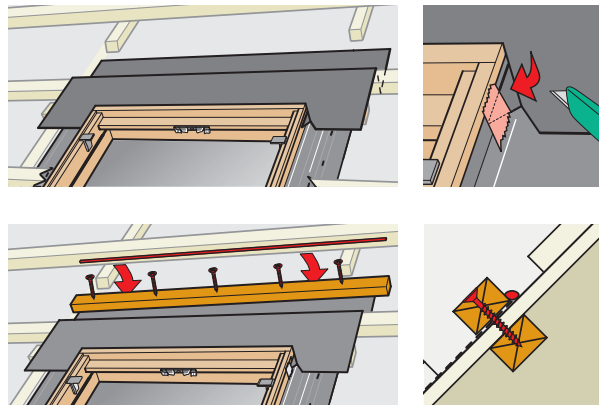



## Special installation conditions

### Cut tiles below the roof window

When positioning the roof window in the roof surface, always allow for a full course of tiles below the window. If conditions on site make this impossible, adopt one of the alternatives described below.

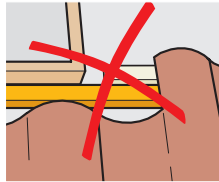

#### Alternative A

Using flexible flashing apron ZZZ 166 (in rolls of 4 m) makes installation possible if the distance between bottom frame and roofing material (a) is increased by up to 240 mm compared to the distance stated in the installation instructions for flashing EDW or EDJ.

The procedure is as follows:

Cut the apron to length (corresponding to the width of the bottom flashing section of flashing EDW or EDJ).

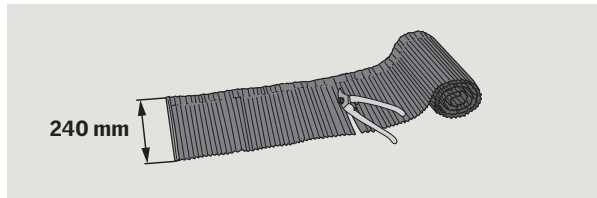

Fasten the apron to a batten with roofing nails. Ensure sufficient overlap on roof tiles.

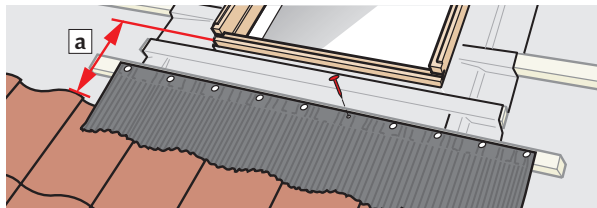

Position the bottom flashing section of flashing EDW or EDJ on top of the apron.

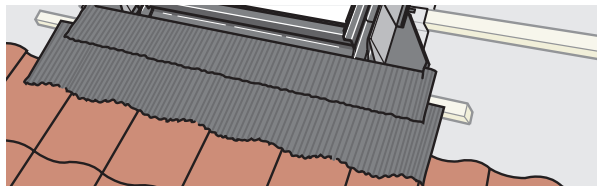

## Special installation conditions

### Cut tiles below the window

#### Alternative B

Cut tiles below the bottom frame of the roof window. Ensure support at the end that has been cut as shown. It may be necessary to chamfer the tiles as shown in the installation instructions.

As the nibs have been removed from the tiles below the window, the tiles must be secured to the battens with screws or nails.

In the measuring example below, the measurements apply to flashing EDW.

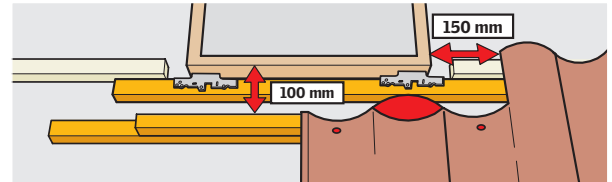

When positioning the bottom flashing section, it may also be necessary to shape the triangular part (b) to the same profile as the tiles.

It will be necessary to use additional self-adhesive flashing material (c) (not a VELUX product) to seal the corners between bottom flashing section and tiles.

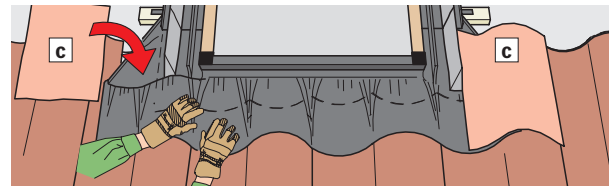
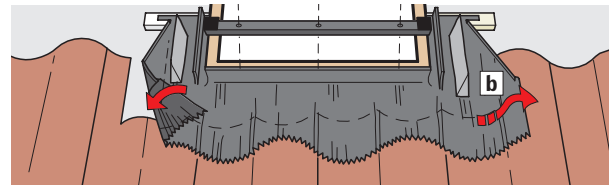

## Special installation conditions

### Roof window installed as a skylight

When installing VELUX roof windows as skylights, ie out of reach, consider choosing mains- or solar-powered roof windows such as VELUX INTEGRA® GGL/GGU and VELUX INTEGRA® Solar GGL/GGU.

Alternatively, it is recommended to lead a cable to the roof window, see page 26. This makes it possible to retrofit electrical accessories such as window operators and mains-powered sunscreening products and employ remote operation.

The installation of the roof window follows standard installation procedures.

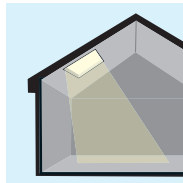
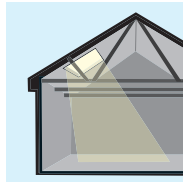

### INSTALLATION IN LIGHT SHAFT

In buildings with unused attics, VELUX roof windows can be installed as skylights by establishing a light shaft.

Observe the following:

- The light shaft must allow the roof window to be rotated 180 degrees to cleaning position, see illustration below. The table shows required distance "A" cm to shaft.

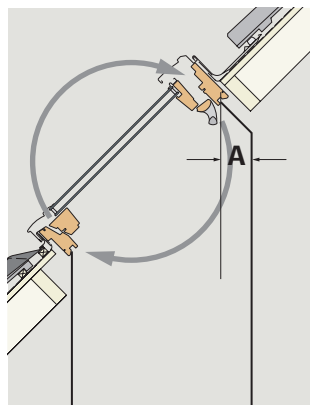
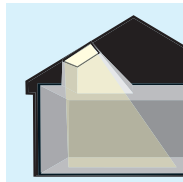

Roof pitch	Window height in cm					
	78	98	118	140	160	180
15°	0	0	0	0	0	0
20°	0	0	0	0	0	0
25°	0	0	0	0	2	3
30°	0	0	0	2	3	5
35°	0	0	2	3	5	7
40°	0	0	3	5	7	11
45°	0	2	5	7	11	15
50°	0	3	7	11	15	19
55°	2	5	11	15	19	24
60°	3	7	15	19	24	30
65°	5	9	19	24	30	36

## Special installation conditions

### Roof window installed as a skylight

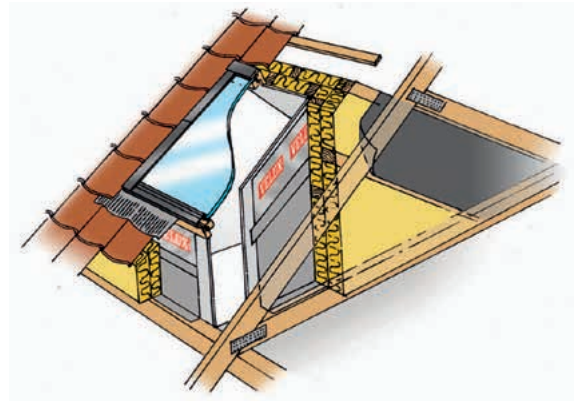

- Connect vapour barrier collar BBX to roof window rebate and extend it by using similar material to existing ceiling vapour barrier. Connect joints with diffusion tight tape.
- Insulate the shaft and depending on the insulating material establish a wind barrier on the exterior of the shaft.
- As the roof windows are installed out of reach, white finish polyurethane windows requiring a minimal amount of maintenance are ideal.

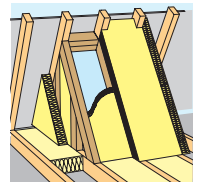
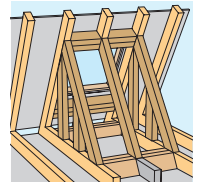

Ensure that all trimming work is carried out to structural requirements where necessary.

- When determining position of the light shaft, consider supported walking areas, ventilation channels, chimneys and antennas/aerials within the roof space/construction.
- When using trimmers between floors, any horizontal loads in the base of the rafter must be taken into account.

## Special installation conditions

### 'Dutch barn' type roofs

Installation in 'Dutch barn' type roofs does not differ much from a standard installation. Several types of roof windows can be installed in vertical position without problems.



The 'Dutch barn' type roofs offer the opportunity of spectacular installations. Two roof windows may for instance be installed on either side of the "break point".

Special flashing components making this possible are available. The distances indicated must be observed.

When contacting VELUX Company Ltd, state roofing material and roof pitches of both roof surfaces.

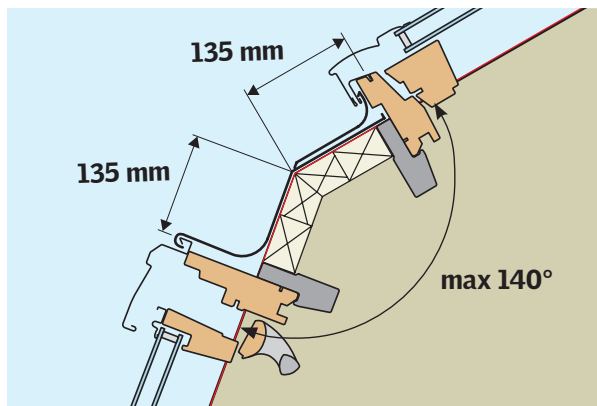

## Special installation conditions

### Installation in connection with vertical wall

There are special aspects to be considered when installing a roof window in connection with a vertical wall. If using VELUX kit for lining LSG or VELUX linings LS-, we recommend the following guidelines:

If the distance (measured horizontally) from the vertical wall to the interior edge of the bottom frame is more than 50 mm, use VELUX lining LS-.

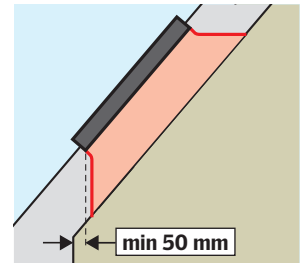

If the bottom frame lies within the distances shown to the vertical wall, use VELUX lining LS- installed with bottom element perpendicularly to bottom frame.

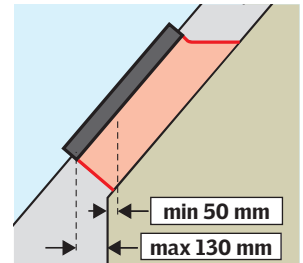

If the bottom frame lies within the distances shown from the angle of the wall, use VELUX lining LS- together with VELUX vertical wall element LEI.

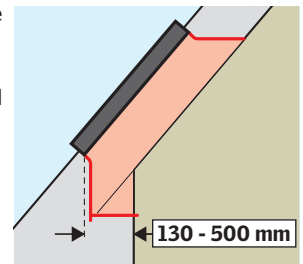

If the bottom frame is positioned as shown, VELUX lining LS- can be used together with VELUX vertical wall element LEI with a sill depth of max 750 mm.

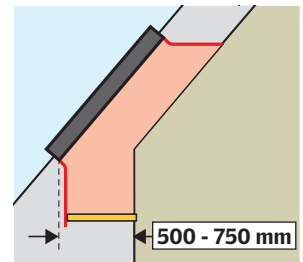

## Special installation conditions

### Flat roof

Use flat roof kerb ECX for installation of VELUX roof windows on flat roofs.

Flat roof kerb ECX can be used in roofs with a pitch between 0° and 15° and roofing material such as roofing felt.



The kerb is made of plywood with pre-installed insulation of polystyrene and polyethylene and is normally flashed externally with the same roofing material as the rest of the roof.

The roofing material is led up to the window and secured. The joint between the roof window and the kerb is then overlapped by the flashing components provided. An on-site lining is used to finish the kerb internally.

## Special installation conditions

### Flat roof

The flat roof kerb can be used with both manually operated and mains-powered centre-pivot windows GGL/GGU and comes in several sizes, see below.

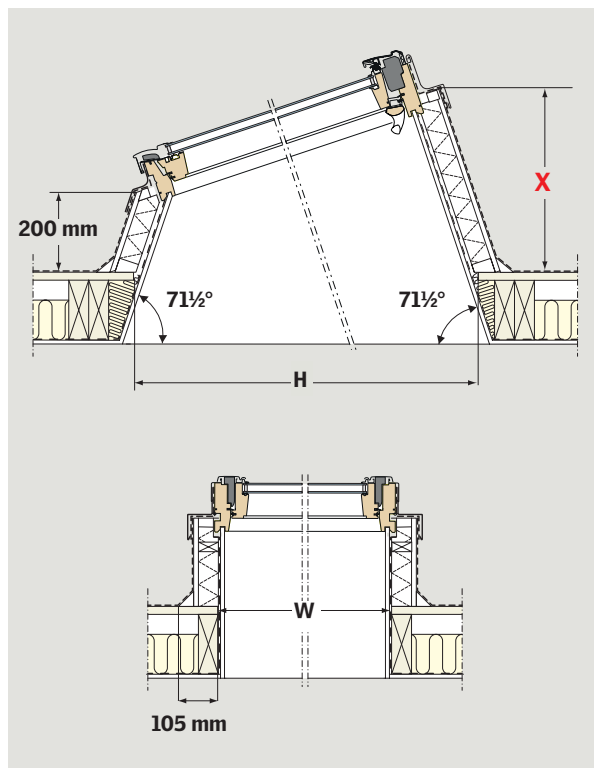

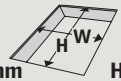
		W mm	H mm	X mm
ECX CK02		600	1000	490
ECX CK04		600	1200	550
ECX MK04		800	1200	550
ECX MK06		800	1400	610
ECX MK08		800	1650	680
ECX PK04		950	1200	550
ECX SK06		1150	1400	610
ECX UK08		1350	1650	680

## Special installation conditions

### Atrium in flat roof

#### ATRIUM

It is possible to install VELUX roof windows in flat roofs (roof pitches from 0° to 15°) to produce an atrium type effect. However, this installation requires special cover and flashing components that must be ordered as flashing ECB.



Cover and flashing components are based on a kerb construction similar to VELUX flat roof kerb ECX. The kerb for the atrium is not part of the VELUX product programme and is to be made on site. Certain dimensions must be respected, see the following drawings.

The dimensions of the kerb vary depending on chosen window sizes and frame distance. Before installing the roof windows, ensure that the construction is structurally stable. Supplementary instructions are enclosed with the special flashing ECB.

When ordering, please state window size and numbers of windows. It is advised to contact VELUX Company Ltd to discuss the specific requirements.

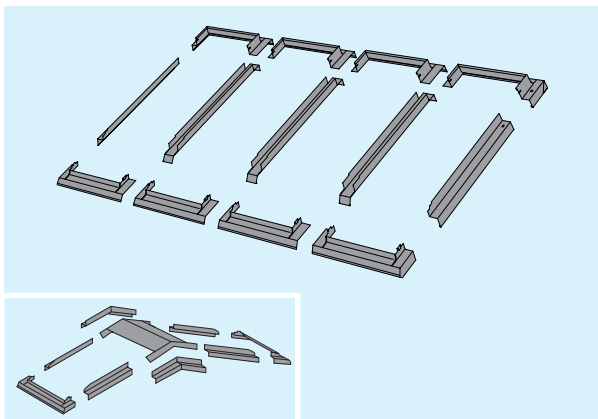

## Special installation conditions

### Atrium in flat roof

**Note:** The pitch of the window in the kerb must always be 20°.

Section, bottom

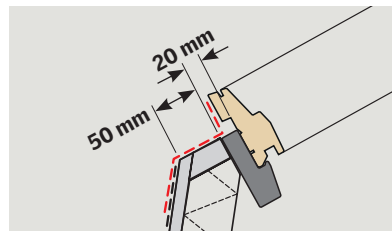

Section, top

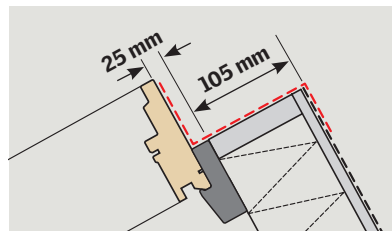

Section, side frame

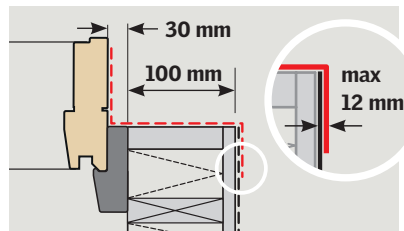

Section between roof windows

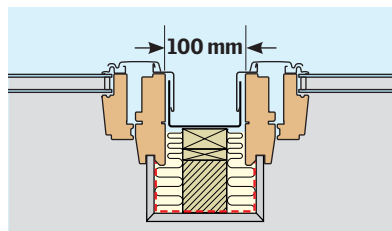

Section, top, if a back-to-back solution is requested

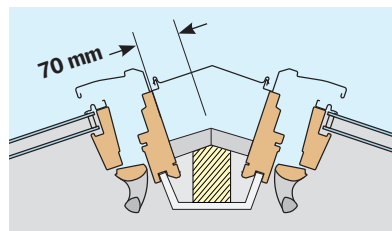

<b>Roofing felt</b>	<b>76-77</b>
<b>Unfelted roofs</b>	<b>78</b>
<b>Principle for adjustment of profiled roofing sheets</b>	<b>79</b>
<b>Profiled metal sheets</b>	<b>80-83</b>
<b>Profiled composite panels</b>	<b>84-87</b>
<b>Metal sheets with pre-formed standing seam</b>	<b>88</b>
<b>Decra (or similar) roofing panels</b>	<b>89</b>
<b>Flat interlocking tiles</b>	<b>90</b>
<b>Traditional standing seam roofs in aluminium or steel</b>	<b>91-94</b>
<b>Slate</b>	<b>95-97</b>
<b>Thatch</b>	<b>98-99</b>
<b>Grass and the like</b>	<b>100-101</b>

## Special roofing materials

### Roofing felt

Use flashing EDL for installation of VELUX roof windows in roofs with roofing felt and a roof pitch steeper than 15°. The flashing must be positioned between the roofing felt layers with correct overlaps which means that the order below must be observed.

**Note:** Under the projection on the window bottom frame, fill in an infill piece such as a piece of plywood (11 x 18 mm) before covering the frame with the bottom layer of roofing felt.

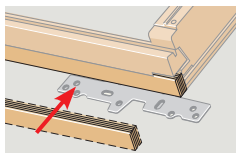

In new roofs, install the roof window after having finished the boarding or sarking and established window aperture in roof.

**1** Position bottom layer(s) of roofing felt on the roof surface around the window. Ensure that the bottom layer of roofing felt covers approx 50 mm of the frame on all sides.

**Note:** Beware of naked flames that might damage the window.

**2** Position top layer of roofing felt from ridge to eaves as close to the window as a full width of roofing felt will allow.

**3** Position top layer of roofing felt from the window to eaves. At least 150 mm must project past the side of the window in the direction of laying.

**4** Cut off bottom corners of bottom flashing section at an angle of 45° and fit.

**5** Fit the remaining flashing and cover parts. Distribute side soakers evenly along the sides of the window. Fasten flashing to roof with roofing nails. Please note that the top flashing section must fit tightly to the window top cover, see page 24.

**6** Position top layer of roofing felt to ridge. Overlap the top layer of roofing felt positioned in ill. 3 and cut the overlapping courses to be level with the bottom edge of the bottom flashing section. The direction of laying (shown from left to right) must be the same as in ill. 2 and 3.

**7** Position top layer of roofing felt on the other side of the window from ridge to eaves.

**8** Finished installation.

Installation in existing roofs follows the same principle as in new roofs with a few exceptions. Please contact VELUX Company Ltd.

## Special roofing materials

### Roofing felt

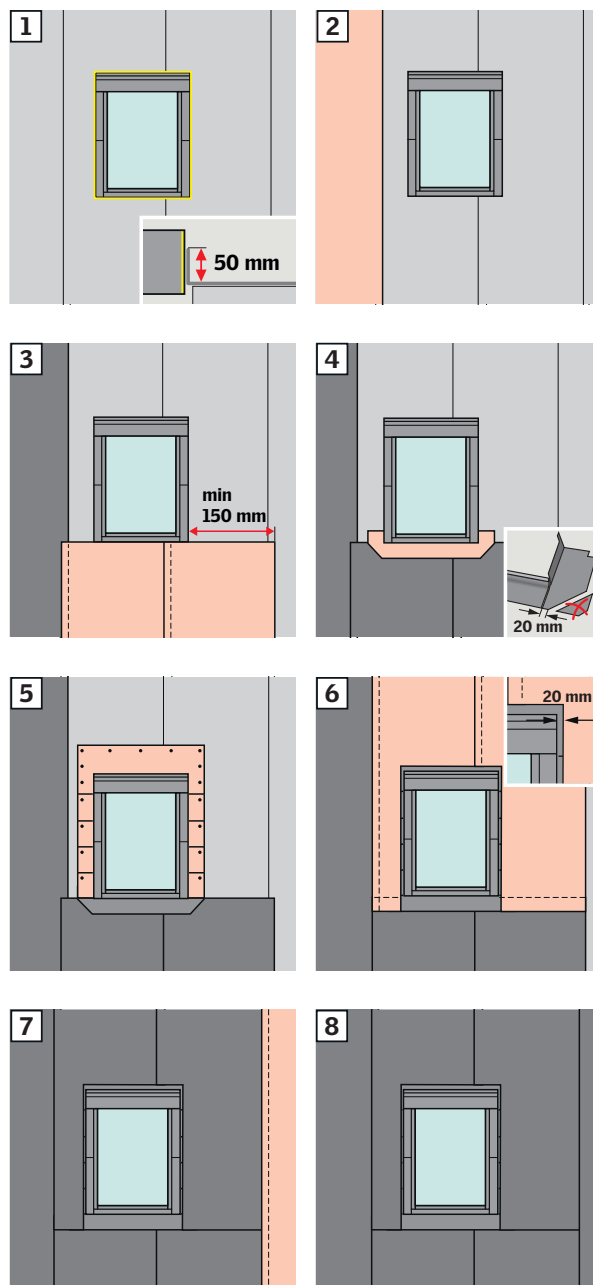

## Special roofing materials

### Unfelted roofs

Use flashing EDW or EDJ for installation of VELUX roof windows in roofs without roofing felt such as roofs with pointed pan tiles.

When installing roof windows in older roofs where roofing felt may not be present, it is still advisable to use an underfelt collar such as VELUX underfelt collar BFX around the window. Alternatively, use normal underfelt material.

The underfelt collar must finish lapped between the underside of the bottom flashing section and the roofing material. Lead the collar to the second row of tiles at the sides of the window and roll it to form a "sausage" that ensures a tight connection under the top of the tiles as shown. Fix the collar to the window with suitable tape and staples. Secure overlap with a suitable tape.

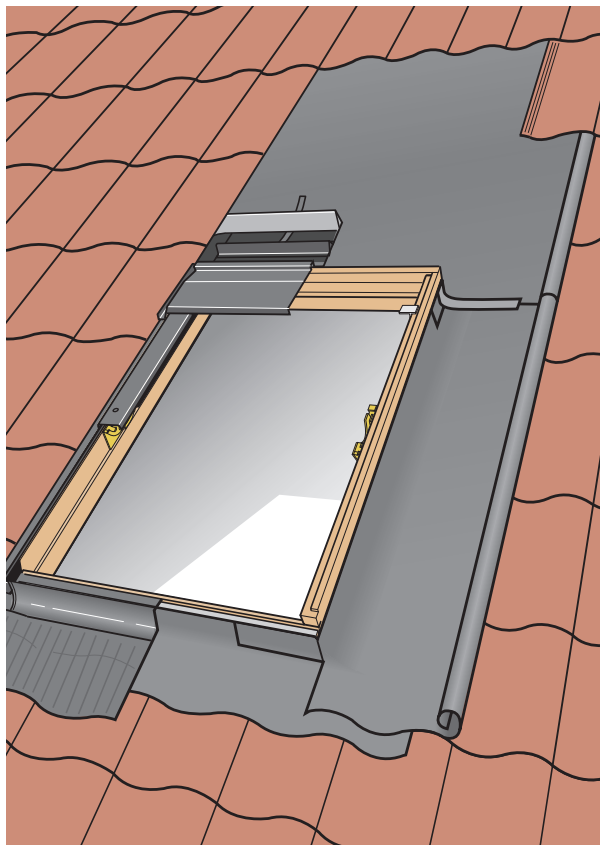

## Special roofing materials

### Principle for adjustment of profiled roofing sheets

Use flashing EDW or EDJ for installation of VELUX roof windows in roofs with roofing sheets, for instance Eternit sheeting.

#### Adjustment when a whole roofing sheet below the roof window is possible:

Position flashing around the roof window (2).

For information about installation battens and distances to the roofing material and other elements in the roof construction, see installation instructions for roof window and flashing respectively.

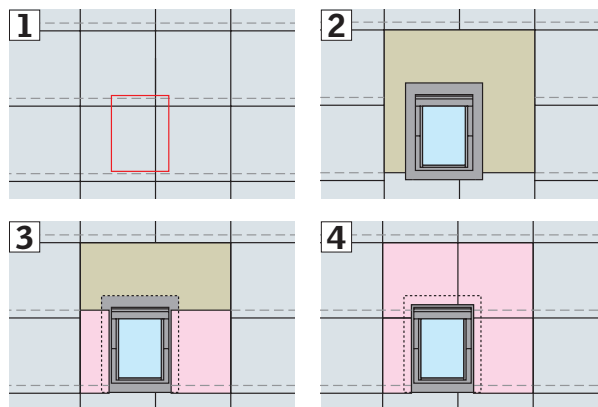

#### Adjustment when a whole roofing sheet below the roof window is not possible:

For flashing EDW, cut the sheets 100 mm (for flashing EDJ: 230 mm) below the roof window. Then finish installation as shown below. Position flashing around the roof window (2).

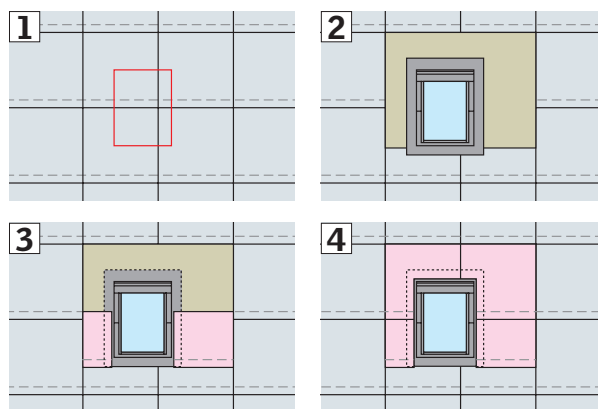



## Special roofing materials

### Profiled metal sheets

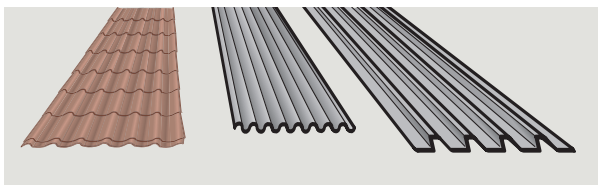

Use flashing EDW or EDJ for installation of VELUX roof windows in roofs with profiled single skin metal sheets that are uninterrupted from eaves to ridge of roof.

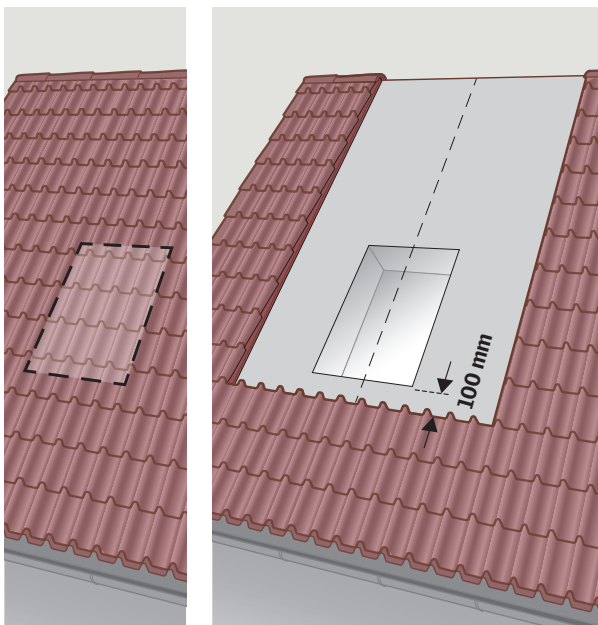

For flashing EDW, cut the sheets 100 mm (for flashing EDJ: 230 mm) below the bottom frame. Install roof window on installation battens observing distances as shown in the installation instructions for the flashing.

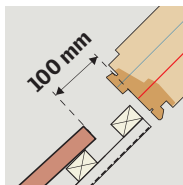

## Special roofing materials

### Profiled metal sheets

Install the flashing around the roof window and shape the bottom flashing section as shown in the installation instructions for the flashing (a).

Position roofing sheets uninterrupted from the bottom frame to the roof ridge along the sides and above the roof window. Observe distances from roofing material to window frame as shown in the installation instructions for the roof window and adjust the foam gaskets of the flashing (b).

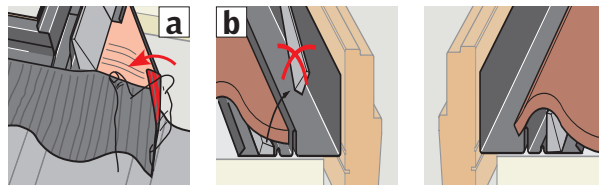
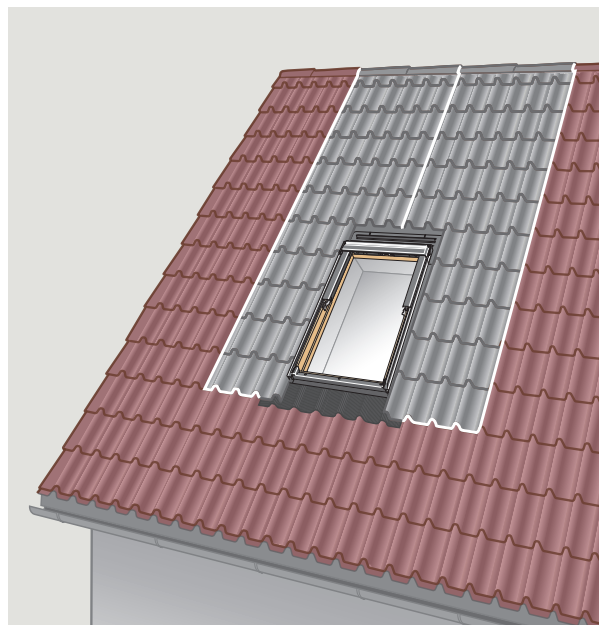

## Special roofing materials

### Profiled metal sheets

If removing roofing sheets as shown on the previous pages is not possible, use the following method (applicable to flashing EDW only, not to flashing EDJ).

Make a hole for roof window as shown.

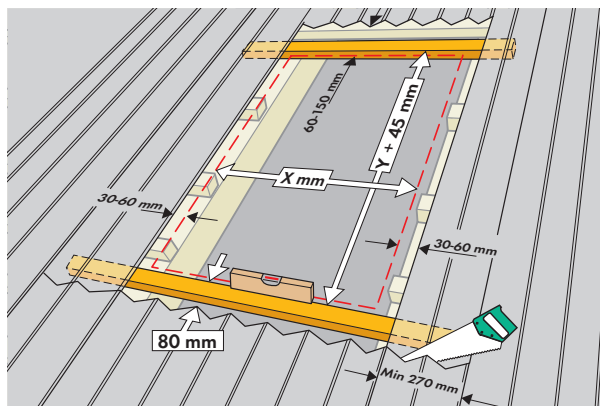

Cut the metal sheets. The distance from the installation batten to the metal sheet roof must be 80 mm. Extend the cut at least 270 mm on both sides of the roof window to make room for the entire bottom flashing section.

Note that the end of the cut must finish on the high profile point of the roofing sheets.

The distance from the side frames to the metal sheet roof must be 30-60 mm. The distance from the top frame to the metal sheet roof must be 60-150 mm.

Position the top flashing section under the metal sheets before installing the window frame. Adjust foam gasket.

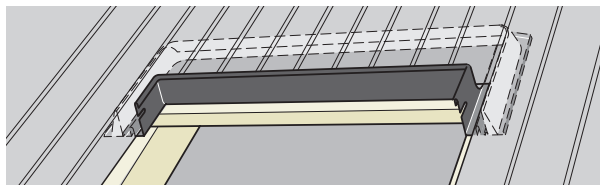

## Special roofing materials

### Profiled metal sheets

Install roof window as shown in the installation instructions for the flashing.

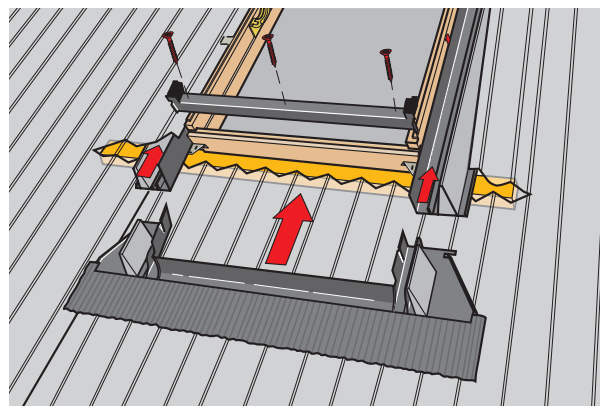

Position side flashings under the metal sheet roof and under the top flashing section. Remember to adjust foam gaskets.

Fold the flexible part of the bottom flashing section and fit bottom flashing section. Note that the sides of the bottom flashing section must be fitted under the side flashings.

Fit covers.

Shape infill pieces from the rest of the metal sheets and fit so that all cuts are covered. Fix infill pieces with for instance rivets but do not puncture the flashing (seal holes with silicone, if necessary).

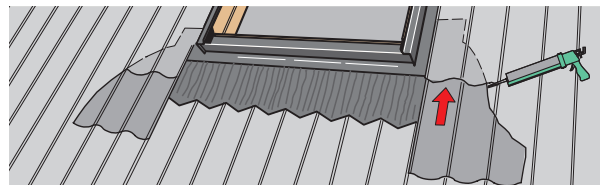

## Special roofing materials

### Profiled composite panels

Use flashing EDW for installation of VELUX roof windows in profiled composite panels.

Composite panels are a continuous roofing material from eaves to ridge. Therefore, to restore continuity after installing the roof window, single skin (non-insulated) panels must be used. Use panels shaped as the roofing material (5a) or plain/flat roofing sheets (5b).

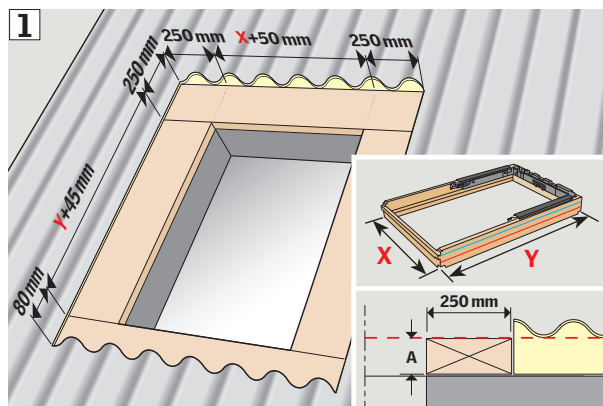

Define the position of the roof window taking into account the structure of the roof. Prepare a wooden subframe to the specifications shown. The height **A** of the subframe must be the same as the base thickness of the panel.

Assemble the frame insulation collar BDX as shown in the instructions supplied with the product and place it in the window opening.

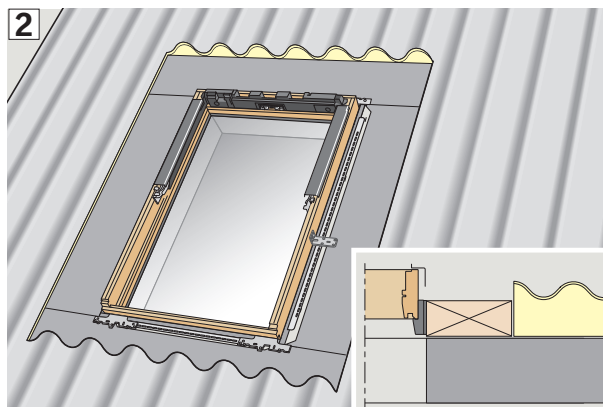

Install the roof window in the wooden subframe as shown in the instructions.

## Special roofing materials

### Profiled composite panels

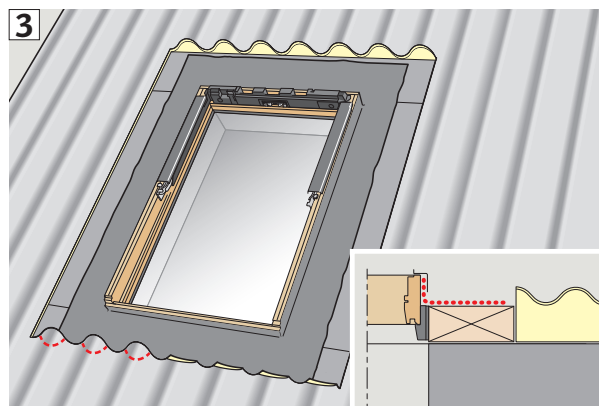

Install the underfelt collar BFX 1000U as shown in the instructions supplied with the product.

**Note:** Chamfer the high profiles of the panel (45°) as shown.

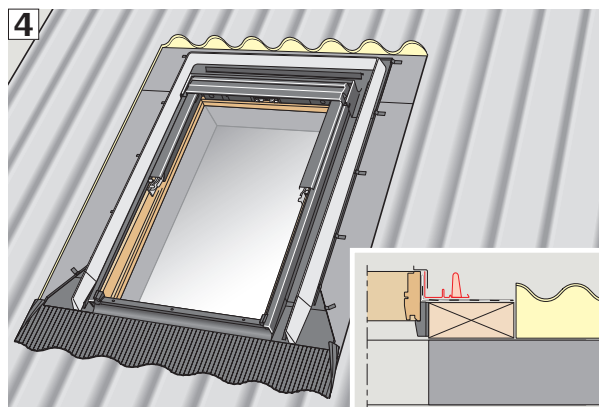

Place flashing EDW as shown in the instructions supplied with the product.

## Special roofing materials

### Profiled composite panels

Corrugated single skin panels

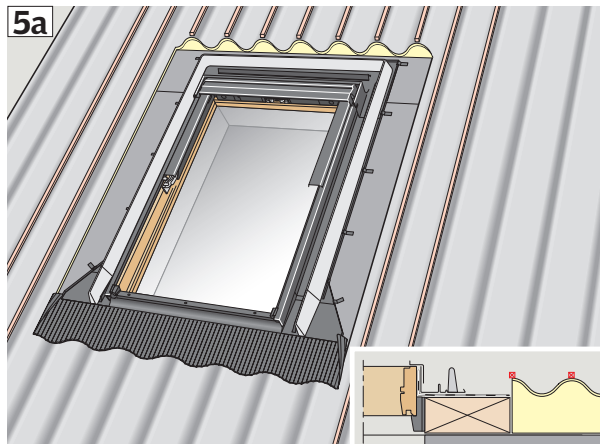

Place spacers (not supplied by VELUX Company Ltd) for micro ventilation between overlapping panels. The spacers must be laid up to the ridge of the roof.

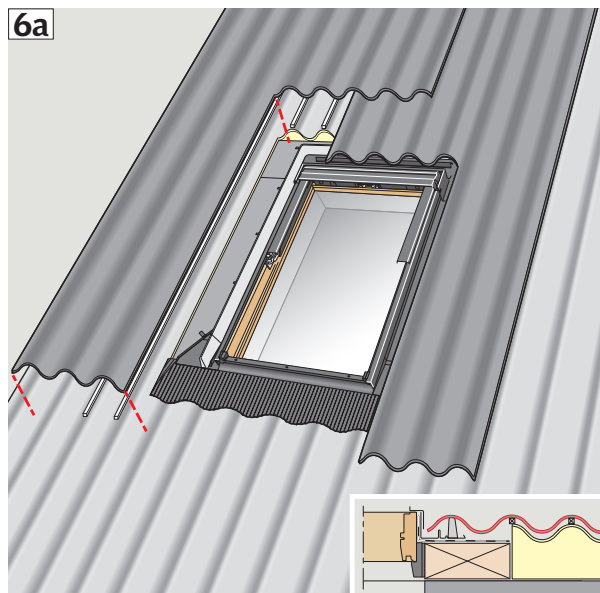

Sheets of non-insulated single skin panels are placed as shown. The sheets must be laid up to the roof ridge.

## Special roofing materials

### Profiled composite panels

Plain/Flat roofing sheets

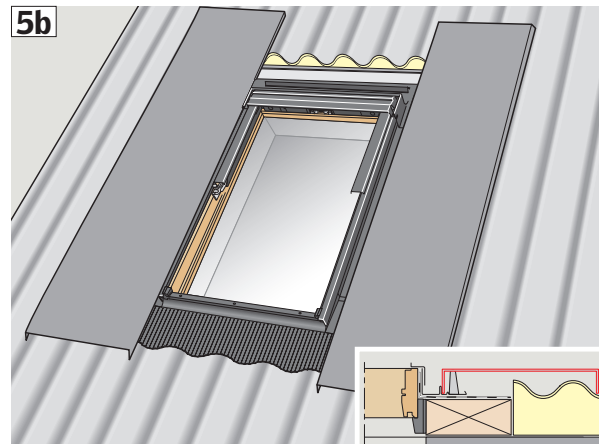

If no corrugated single skin panels are available, make two profiles of plain roofing sheet. The sheet must overlap the side sections of the flashing.

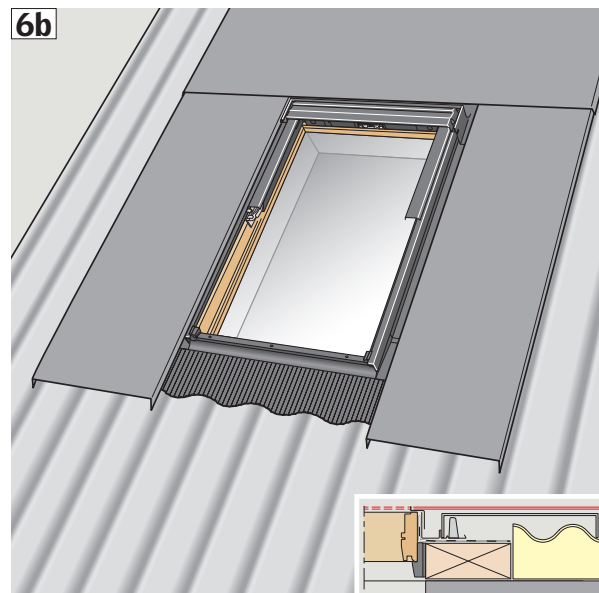

Repeat the previous step, making a third profile of plain/flat roofing sheet that overlaps the two side profiles. The sheet must reach the roof ridge.

## Special roofing materials

### Metal sheets with pre-formed standing seam

Use flashing EDW or EDJ for installation of VELUX roof windows in roofs with pre-formed steel sheets that are "snapped" together.

**Note:** Flashing EDE can be used for pre-formed zinc or copper metal sheets.

Install the roof window as shown in the installation instructions for the flashing. Follow normal procedure for connection of underfelt and insulation.

Position the metal sheets below the bottom frame, not closer to the frame than the bottom installation batten. The sheet must continue at least 200 mm past the frame at the sides to make space for fitting the bottom flashing section (1).

Fit the bottom flashing section and shape the flexible part of it around the ribs of the metal sheets. Fold the bottom flashing section as shown in the installation instructions so that it presses against the metal sheets (2).

Fit the flashing around the roof window and cut the foam gasket to a height of approx 25 mm (3). Flatten the rib of the top flashing section on both sides.

Position metal sheets around the roof window. The distances from the metal sheets to top and side frames follow the standard instructions (4). Fix metal sheets around the window with appropriate screws and washers. Do not screw through the flashing.

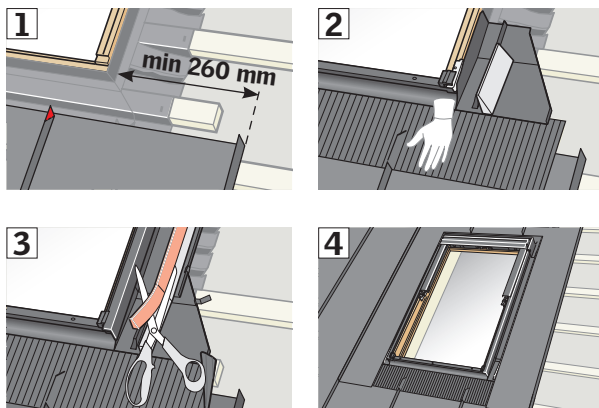

## Special roofing materials

### Decra (or similar) roofing panels

Use flashing EDW or EDJ for installation of VELUX roof windows in roofs with Decra roofing panels.

The lowest level of these roofing panels is below the top face of battens. Therefore the roof window and flashing must be installed correspondingly deeper in the roof.

Establish a recessed area around the roof window for the flashing. This area must be 25 mm below the top face of the battens. Ensure support of the battens if their load capacity is reduced.

**Note:** If it is not possible to keep a full roofing panel below the roof window, please contact VELUX Company Ltd.

In the measuring example below, the measurements apply to flashing EDW.

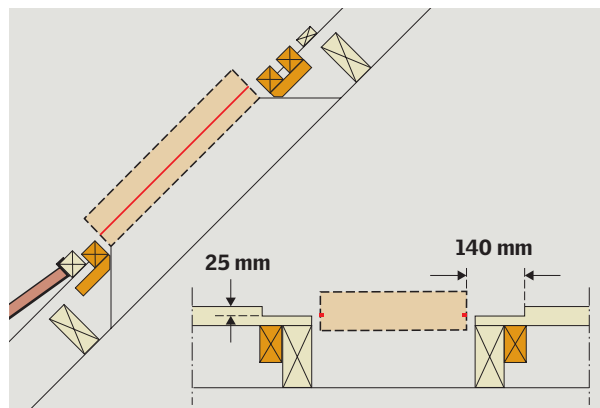
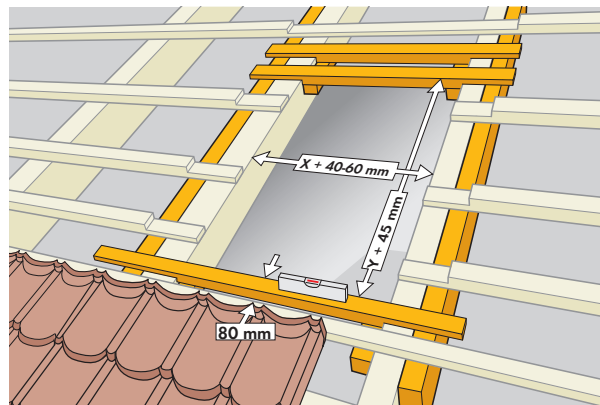

## Special roofing materials

### Flat interlocking tiles

Use flashing EDW or EDJ for installation of VELUX roof windows in roofs with flat interlocking tiles such as Wienerberger, Stonewold and the like.

Install the roof window as shown in the installation instructions supplied with the flashing. In cases where very thin types of flat interlocking tiles have been used, it may be necessary or advisable to install window and flashing deeper in the roof to avoid the rib of the flashing lifting the roofing material.

Establish a recessed area around the roof window for the flashing. This area must be 10 mm below the top face of the battens. This measure balances out the small rib of the flashing so the flat tile can be laid close to the high rib, cf. illustration. Ensure support of the battens if their load capacity is reduced.

**Note:** As roof window and flashing are installed deeper in the roof, the roof pitch must be at least 30° to ensure optimum drainage near the bottom flashing section.

In the measuring example below, the measurements apply to flashing EDW.

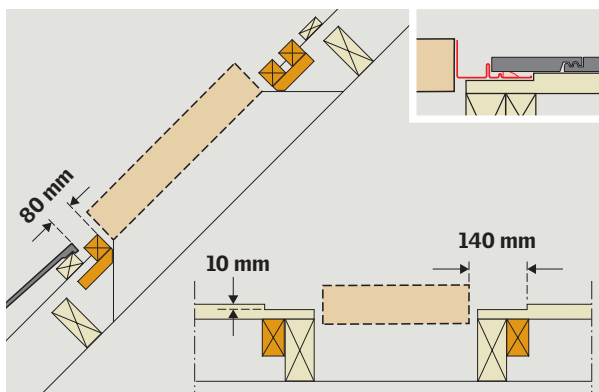
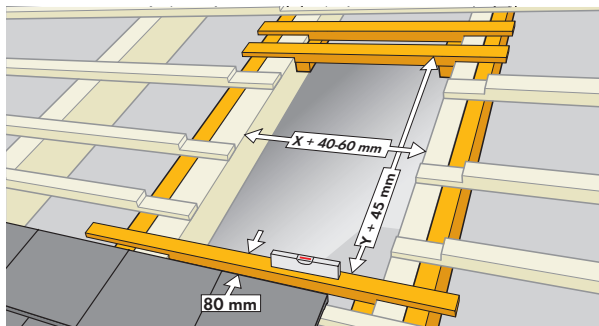

## Special roofing materials

### Traditional standing seam roofs in aluminium or steel

The installation of VELUX roof windows in traditional standing seam roofs in aluminium or steel can be made by a metal roofer according to the guidelines on the following pages.

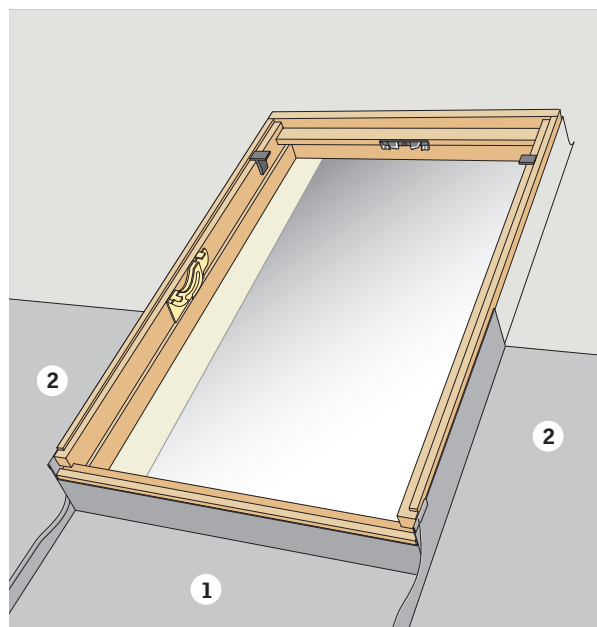

## Special roofing materials

Traditional standing seam roofs in aluminium or steel

### Template for bottom corners

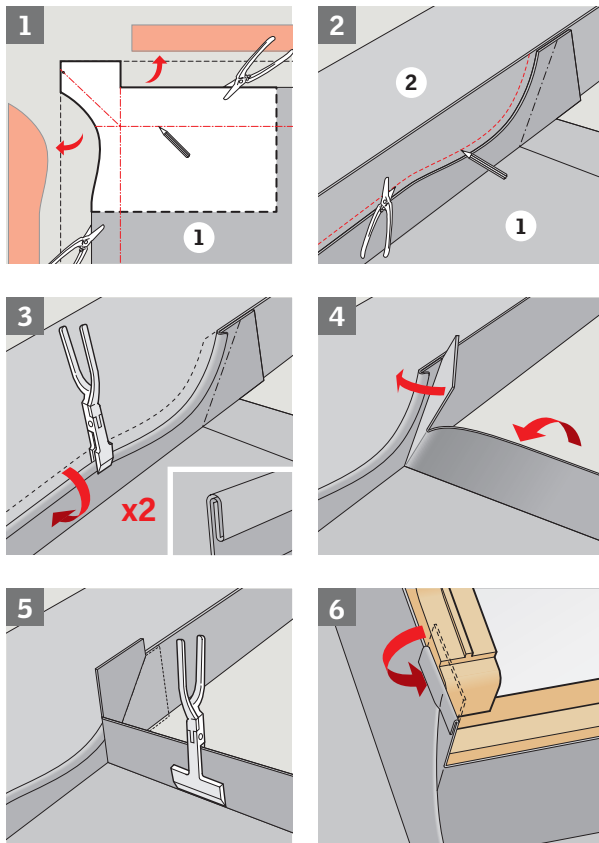
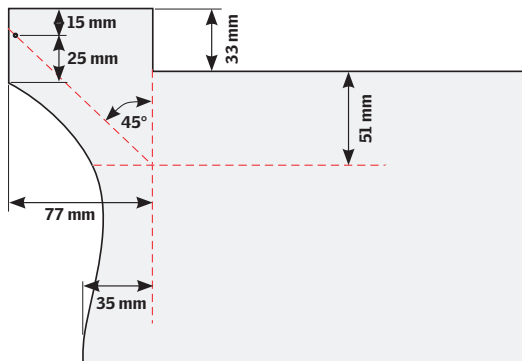

## Special roofing materials

Traditional standing seam roofs in aluminium or steel

### Template for top corners

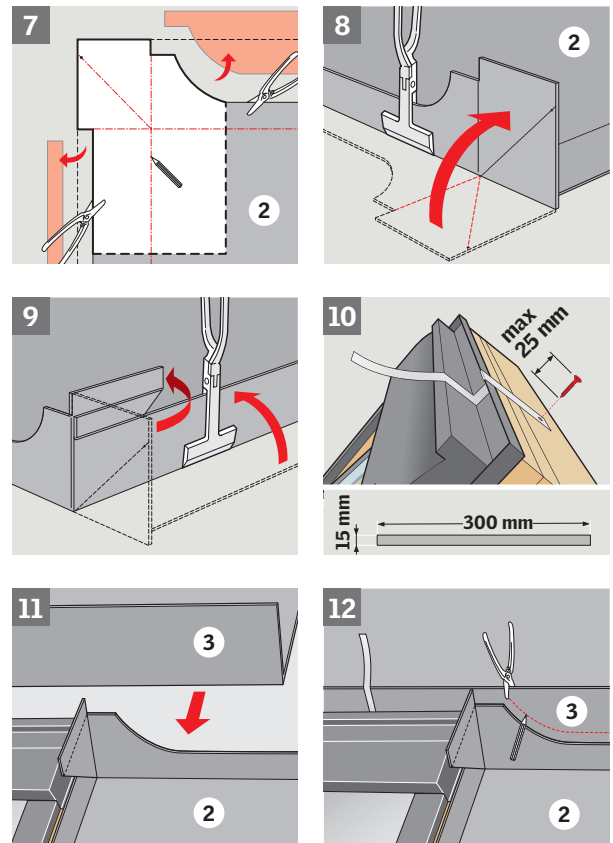
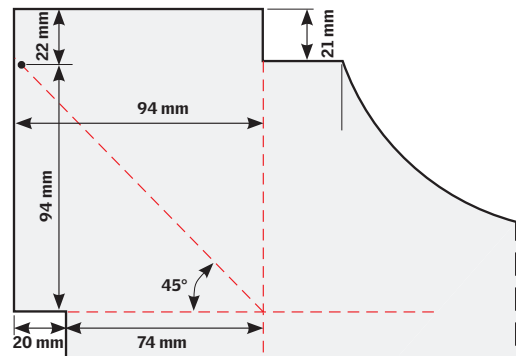

## Special roofing materials

### Traditional standing seam roofs in aluminium or steel

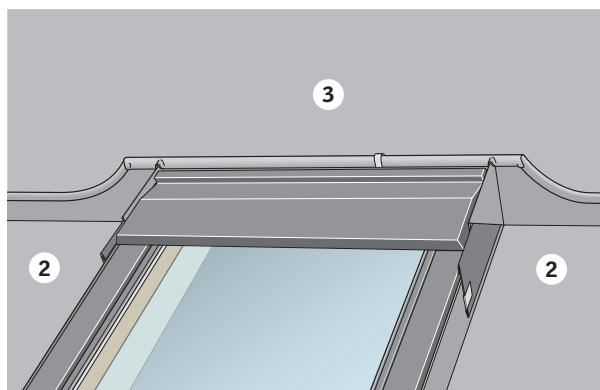
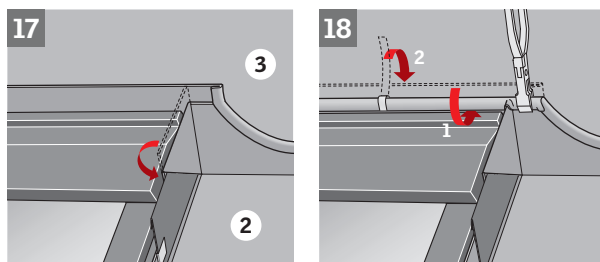
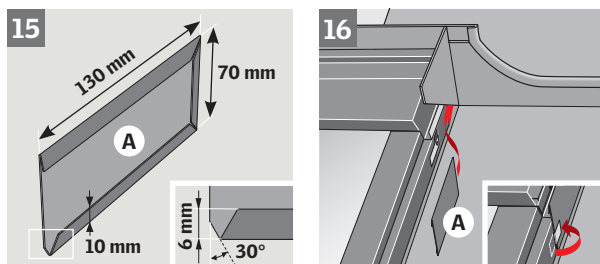
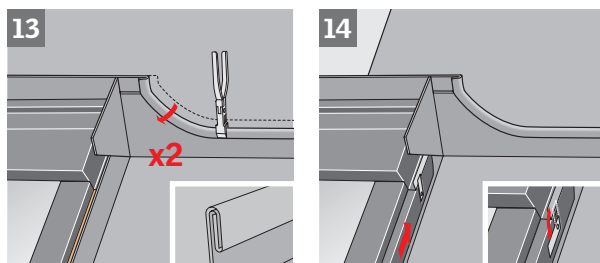

## Special roofing materials

### Slate

Use flashing EDL in red level and flashing EDN in blue level for installation of VELUX roof windows in slate roofs.

A slate roof is tight because of the overlapping of the individual slates. The required overlap depends on the roof pitch, local climatic conditions etc.

When flashing a roof window in a slate roof, the flashing parts must be fitted in such a way that they "replace" the slates that were removed when the window was installed.

Therefore, when determining the position of the window in the roof, the bottom flashing section must be considered, ie it must be in line with the slates thus "replacing" the slates removed (a).

If this is not possible, the required overlap must be established in a different way, for instance by fitting an extension piece made-on-site under the bottom flashing section (b).

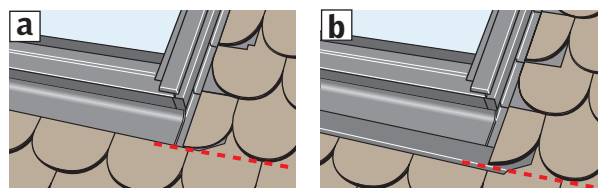

Flashing EDL is designed for slates with a thickness of up to 8 mm (1). By adjusting the side soakers, the flashing can be installed in slates with a thickness of up to 20 mm (2).

Special flashing installation instructions EDL+ are available, please contact VELUX Company Ltd.

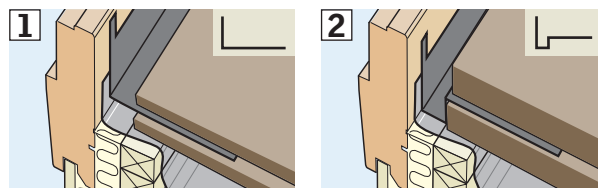



## Special roofing materials

### Slate

When installing VELUX roof windows in existing stone slate roofs, follow the following procedure:

- Determine position of roof window in relation to slate overlap.
- Find slate **A** based on the measurements in the illustration and remove it. In addition, remove the other slates within the marked area. The example shows lap slates, a drop-shaped natural stone slate with a notch to fix it with wire nails at the sides. Use flashing instructions EDL+ as this slate type is often thicker than usual. Notice the position of the slates, mark them if necessary. Do not remove the wire nails. The slates must be laid in the same place again because of the hidden roofing nails.

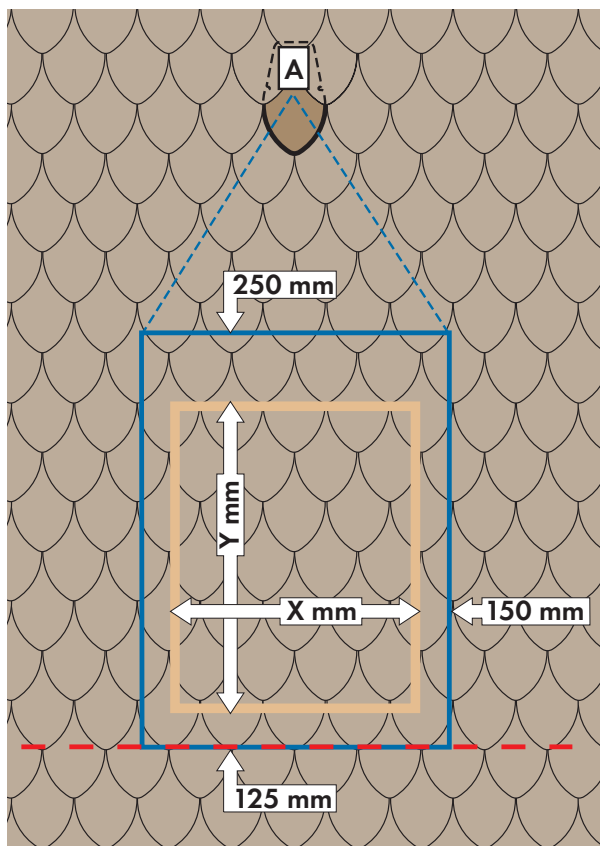

## Special roofing materials

### Slate

- The hole in the roof can now be made according to the measurements in the flashing instructions.
- Install installation set BDX 2000 and roof window.
- Install covers and lay the slates. Note: The slates must be laid in the opposite order, ie from the bottom and upwards. End with slate **A**, which is to be fixed with visible nails.

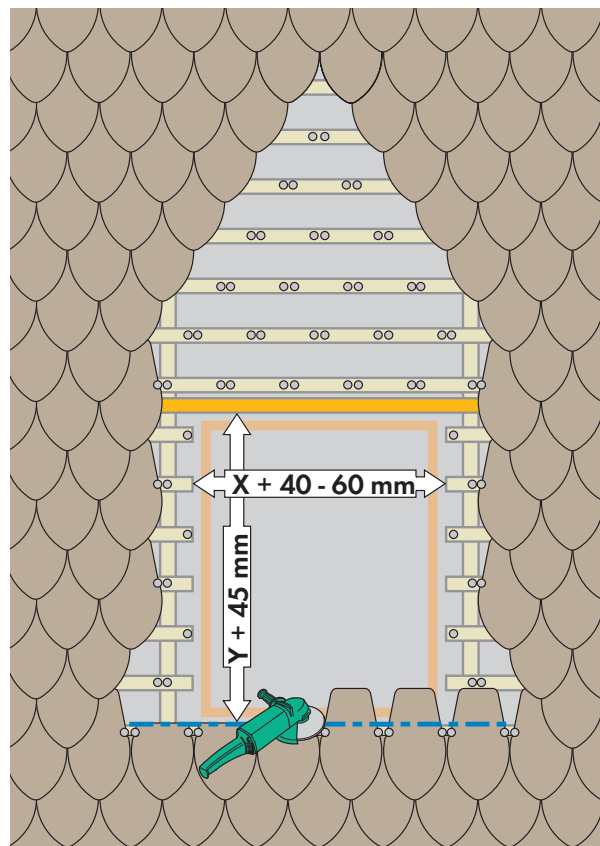

## Special roofing materials

### Thatch

Use flashing EDW with flexible flashing apron ZZZ 166 (pleated aluminium roll) for installation of VELUX roof windows in thatched roofs.



Build a frame from 45 x 95 mm members as shown. Position frame on battens and fix to roof construction. Install roof window on this frame.

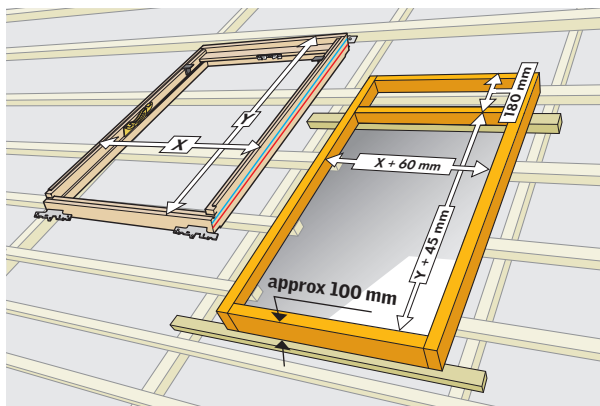

## Special roofing materials

### Thatch

When installing roof windows in thatched roofs please note that the thatched roof must be made fireproof in accordance with local regulatory requirements.

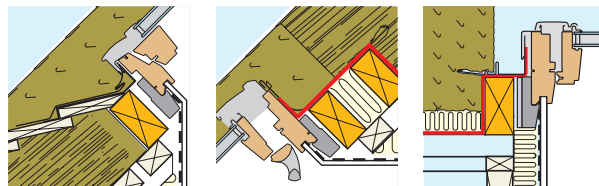

The drawing shows the principles for installation of a roof window in a roof construction with fire-resistant membrane shown in red. The roof construction must always be adjusted to the specific building, local architectural tradition and the directions of the building material supplier.

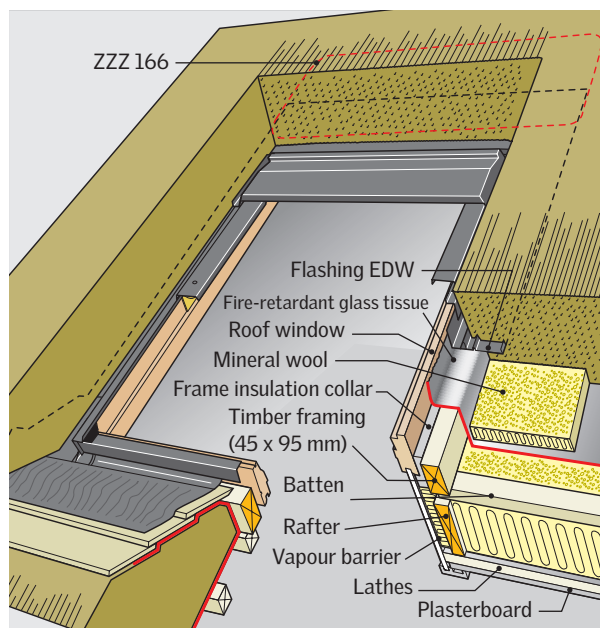

## Special roofing materials

### Grass and the like

Use flashing EDL for installation of VELUX roof windows in grass roofs and other types of roofing with a thick layer of natural materials such as seaweed or shells.

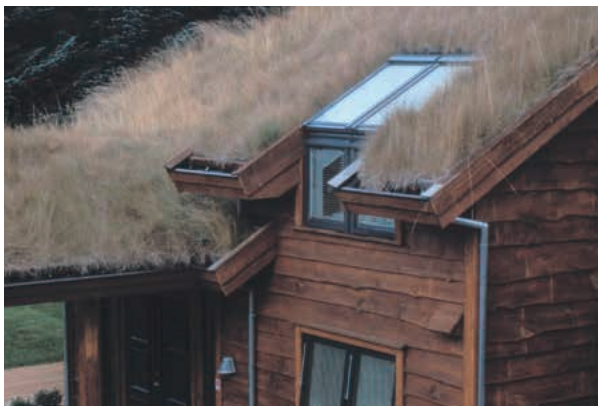

In these roof constructions, a watertight membrane under the natural materials ensures a tight seal around the installation. The membrane is led from the roof surface to a built-up platform and up along the sides of the frame all around the roof window.

Establish frame with the dimensions shown. The platform must be level with the natural material. Chamfer the edges of the frame to reduce the possibilities of the membrane cracking or splitting. Establish transverse drainage above the frame.

If the membrane consists of two layers, position both layers before fitting the flashing. Fit the flashing all around the roof window. Fold down edges of flashing over the platform at the sides so that the natural material can cover the edges of the flashing. Position a humus resistant flashing component over the top flashing section. Bend the flashing component so that it follows the upper side of the frame. This flashing component is not supplied by VELUX Company Ltd.

## Special roofing materials

### Grass and the like

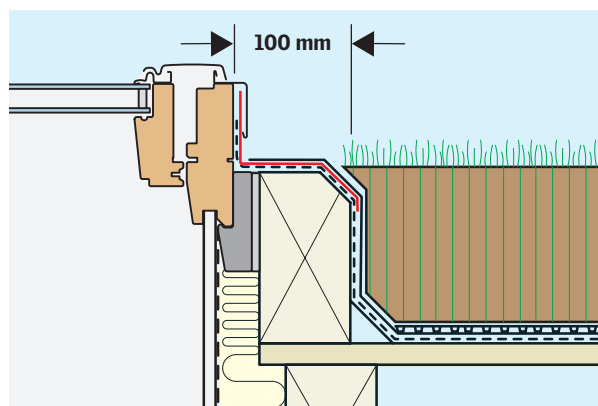
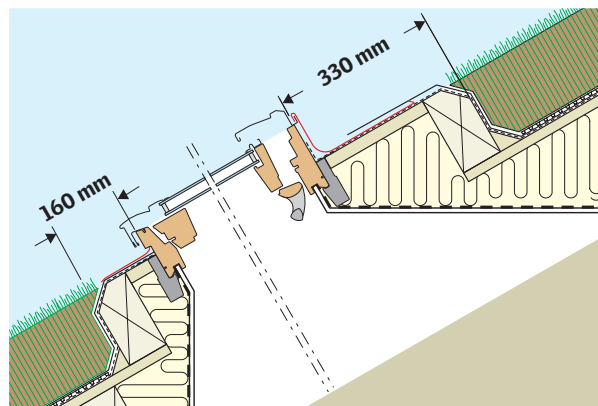

---

<b>Replacing roof windows</b>	<b>104-107</b>
-------------------------------	----------------

---

<b>Spare parts</b>	<b>108</b>
--------------------	------------

---

<b>Removing sash (roof windows GPL/GPU)</b>	<b>109</b>
---	------------

---

<b>Replacing insulating glass units</b>	<b>110-111</b>
---	----------------

---

<b>Replacing roof windows in slated roof</b>	<b>112-113</b>
--	----------------

---

## Replacement / Renovation

### Replacing roof windows

A VELUX roof window is designed to last for many years. A minimal amount of maintenance ensures a fully functional window provided that the roof window gaskets and the flashing foam gaskets, if any, are replaced as and when required, see page 108.

The VELUX Group is continuously working to improve the products, and therefore it will at some point be an advantage to replace the window instead of renovating it.

Advantages when replacing the old window with a new VELUX roof window:

- Improved U-value – saving more energy.
- Option to choose another window type – for instance changing from a centre-pivot to a top-hung roof window, from a timber to a polyurethane roof window or from a manually operated to a VELUX INTEGRA® roof window. VELUX INTEGRA® Solar roof windows are particularly suitable if you want to avoid routing cables as they are solar powered and therefore require no connection to the mains power supply.
- More attractive design – better integration in the roof.
- Guarantee for tightness and insulation around the roof window when using VELUX installation products together with the window.

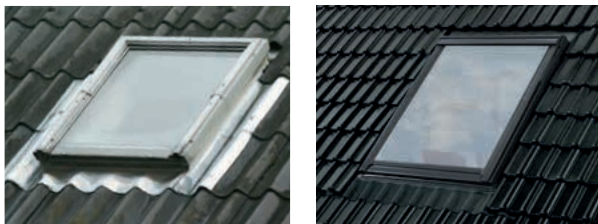

### TO BE CONSIDERED BEFORE REPLACEMENT

VELUX Company Ltd can assist in finding a suitable solution for replacing old roof windows – regardless of size and brand.

Basically there are two replacement situations:

- 1 Replacing both roof window and lining
- 2 Replacing the roof window only, maintaining the existing lining

## Replacement / Renovation

### Replacing roof windows

#### 1 REPLACING BOTH ROOF WINDOW AND LINING

This solution is definitely the most advisable one to apply. It is equivalent to a new installation where the roof window is installed in accordance with optimum conditions as to connections to insulation, underfelt and vapour barrier.

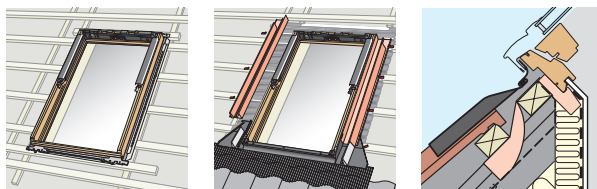

Install the roof window following standard procedure according to the instructions for the chosen flashing. However, check whether the position of lower trimmer allows room for blue level installation.

VELUX installation set BDX 2000 including underfelt collar BFX is applicable given sufficient space between window frame and rafters.

In this replacement situation, the numerous possibilities should be considered carefully. You might for instance choose a larger roof window or install additional roof windows in combinations. Be sure to check whether the rafter distance allows for a wider roof window. If not, trimmers must be installed.

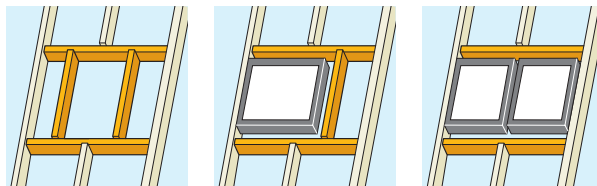

## 2 REPLACING THE ROOF WINDOW ONLY, MAINTAINING THE EXISTING LINING

There might be instances where it is not possible or desirable to remove the existing lining. Depending on the actual situation there are various solutions.

Since 1968 VELUX roof windows have been produced with standard dimensions. It is therefore almost always possible to get a new roof window with dimensions that match those of the old window.

VELUX roof windows manufactured since 1999 have as standard been installed 27 mm deeper in the roof surface to ensure a better design or improved heat insulation.

In a replacement situation, it is therefore important to notice the installation level of the roof window, see the examples in **2.1** and **2.2**.

### 2.1 MAINTAINING THE LINING WITH ALTERATIONS

If the roof window to be replaced is manufactured before 1999, the new roof window will be designed to be installed deeper in the roof than the old window. This means that the lining must be reduced by 27 mm on all sides. Position frame in the lining and secure with installation brackets.

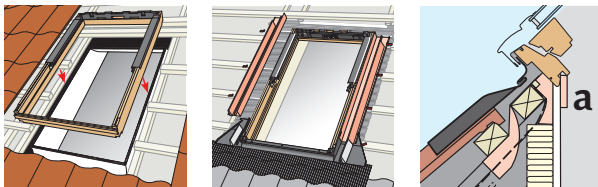

Fit standard flashing following standard procedure. The lining now fits into the frame rebates but if the lining is splayed top and bottom, the connection can be finished either by fitting facings (a) or by pushing the roof window upwards to make the window fit into the lining at the top and providing an additional lining element at the bottom.

VELUX installation products BDX and BFX should be used if possible. Frame insulation collar BDX may have to be adjusted at the top and/or bottom.

### 2.2 MAINTAINING THE LINING WITHOUT ALTERATIONS

The replacement roof window will be installed above its normal installation height. To compensate for this position there are two possible solutions:

- When replacing single roof windows, use VELUX replacement flashing EW (for profiled roofing materials) or EL (for flat roofing materials).
- Alternatively, use VELUX extension flashing ELX together with a standard flashing. When replacing combined roof windows, use VELUX extension flashing ELX together with a standard combi flashing. Please note that one extension flashing is required per roof window.

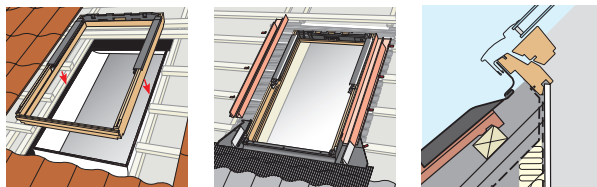

Position the frame on the lining and secure with installation brackets supplied with the flashing.

VELUX underfelt collar BFX can be used whereas frame insulation collar BDX cannot.

The projected positioning of the roof windows reduces the insulating properties somewhat but this loss can be compensated for by using the insulated flashing variants EW 6000 or EL 6000 where the insulation is provided around the frame above batten level. As the insulation lies over batten level, the flashing takes up more room in width. It may therefore be necessary to adjust the roofing material along the roof window.

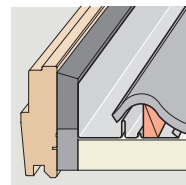

# Replacement / Renovation

## Spare parts

VELUX products are designed to last for many years. Even with a minimal amount of maintenance, parts must, however, be replaced at regular intervals. Consequently, VELUX Company Ltd offers a wide range of spare parts that are available many years beyond the time of purchase.

To make maintenance easy for you, various VELUX DIY service kits have been developed (general maintenance, repair lacquer etc).

For more information, please contact VELUX Company Ltd or visit [www.velux.nn](http://www.velux.nn) where you will find information about how to order spare parts. When ordering, please state window type and size specified on the data plate of the window, see page 140.

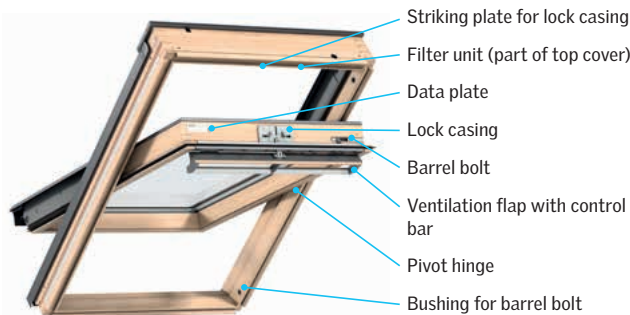
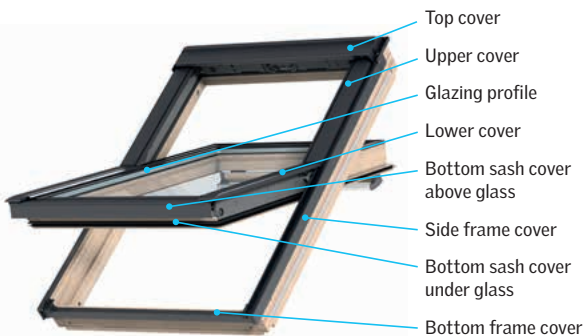

# Replacement / Renovation

## Removing sash (roof windows GPL/GPU)

Before removing the sash on top-hung roof windows, the springs must be disengaged.

Relieve the pressure on the springs by raising the sash fully.

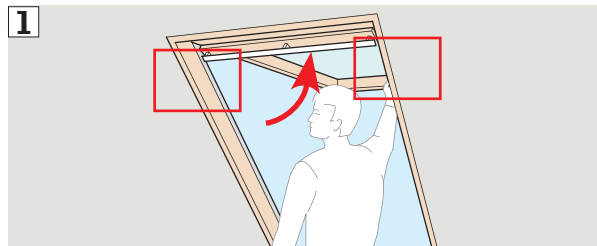

Using a screwdriver, the springs can now be disengaged by releasing them from the sliding carriage.

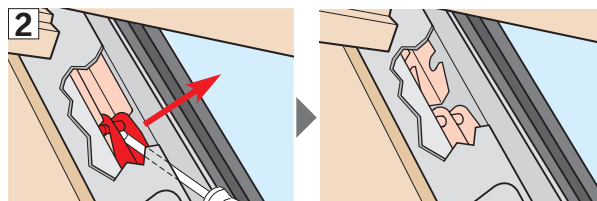

Close the sash and rotate it.

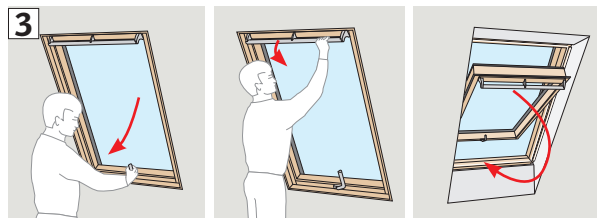

Press in the button and remove the sash.

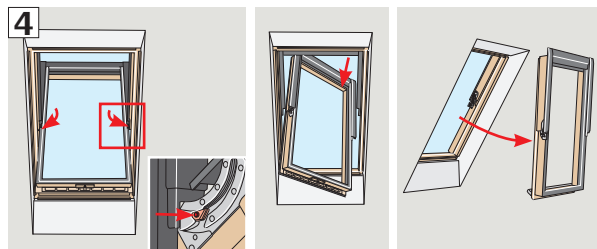

## Replacement / Renovation

### Replacing insulating glass units

If replacement of the insulating glass unit in a roof window is required, complete VELUX replacement kits with all necessary components are available.

A replacement kit includes:

- New insulating glass unit (available with different qualities)
- Sealants
- Complete set of instructions

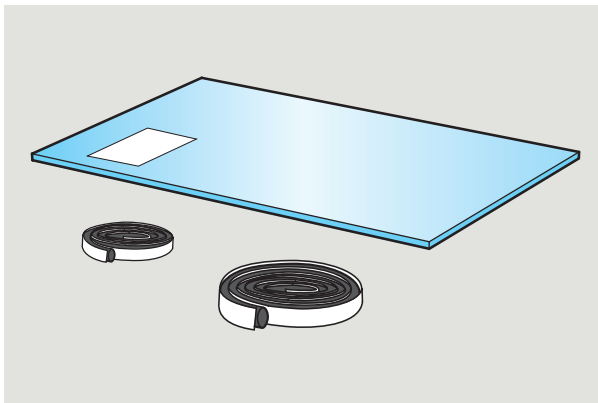

The replacement kit is available from VELUX Company Ltd or [www.velux.nn](http://www.velux.nn). Be sure to state window type and size from the data plate of the roof window.

The replacement kit is delivered in a cardboard packaging.

## Replacement / Renovation

### Replacing insulating glass units

The procedure is simple:

1. Remove sash and place it for instance on trestles.
2. Unclip covers and unscrew glazing profile. Lift out the old insulating glass unit.
3. Place new insulating glass unit in sash.
4. Clean glazing profile and bottom sash cover. Apply new adhesive sealant.
5. Refit glazing profile and covers. Replace sash.

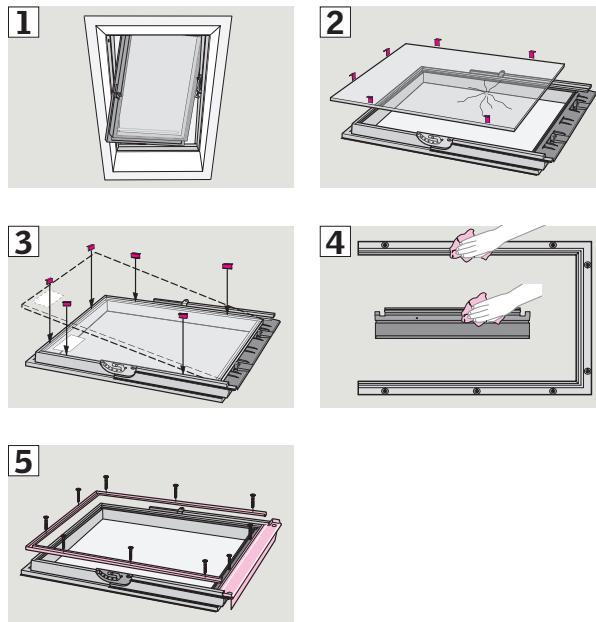



## Replacement / Renovation

### Replacing roof windows in slated roof

In roofs with slates, use VELUX flashing EDL when replacing an old roof window with a new one. In most cases, the installation instructions for the flashing can be followed.

If it is either not desirable or not possible to remove the slates, follow this procedure:

#### REMOVING THE OLD ROOF WINDOW

1. Remove the window sash and all window covers.
2. Saw the side frames and remove carefully.
3. Carefully draw out side soakers and top and bottom flashing sections. If the components are stuck in slate putty, loosen the individual slate layers carefully from the flashing components with a handsaw.  
Remove putty from between the slate layers with the handsaw.

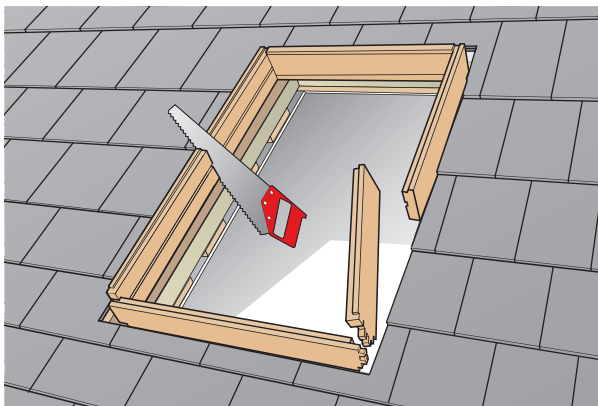

## Replacement / Renovation

### Replacing roof windows in slated roof

#### POSITIONING THE NEW FLASHING

4. Apply slate putty to the top flashing section and push it diagonally up between the slates.
5. Apply slate putty to the side soakers and position them top-down between slate layers. Follow the same procedure when fitting the bottom flashing section.

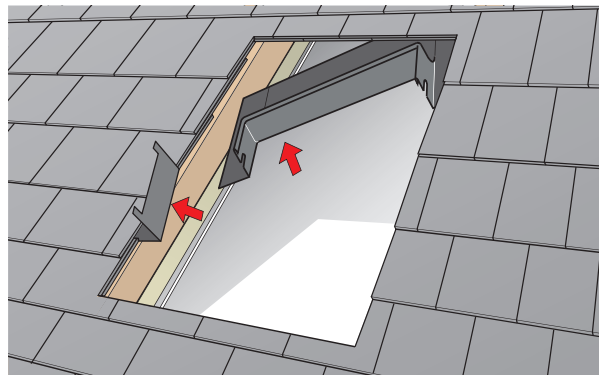

#### POSITIONING THE NEW ROOF WINDOW

6. Fit four pieces of flat pre-galvanised straps to the side frames.
7. Provide timber infill blocks on rafters to establish base for fixing of straps.
8. Lift frame into position from the inside and fix. Ensure red line on frame is level with top of slate battens/boarding.
9. Follow standard procedures for fitting of exterior covers and interior lining.

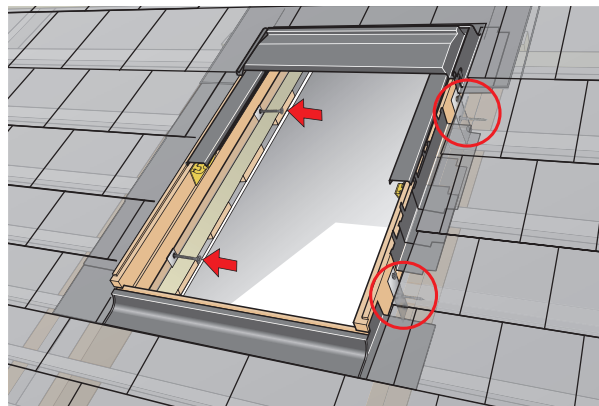

<b>Roof construction</b>	<b>116</b>
<b>Roofing material</b>	<b>117</b>
<b>Underfelt</b>	<b>118-120</b>
<b>Bearing construction</b>	<b>121-122</b>
<b>Thermal insulation: U-value</b>	<b>123</b>
<b>Solar gain: g-value</b>	<b>124</b>
<b>Vapour barrier</b>	<b>125-126</b>
<b>Interior ceiling finish</b>	<b>127</b>
<b>Ventilation of habitable rooms</b>	<b>128</b>
<b>Sound insulation</b>	<b>129</b>
<b>Snow and ice on and around VELUX roof windows</b>	<b>130-135</b>

A modern roof is a complicated construction consisting of many different materials with many different functions.

1. **Roofing material** – forms basic protection against water (rain and snow), hail etc
2. **Underfelt** – protects against rain and snow and serves partly as wind barrier
3. **Bearing construction** – rafters, battens
4. **Thermal insulation** – minimises heat loss
5. **Vapour barrier** – prevents air and vapour penetration
6. **Interior ceiling finish**

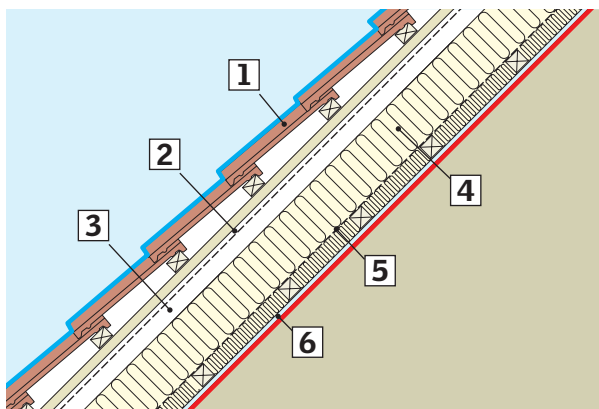

When this construction is interrupted by the installation of a roof window, stringent demands are made upon the connections between the window and the surrounding construction to ensure continuity of the structure's performance.

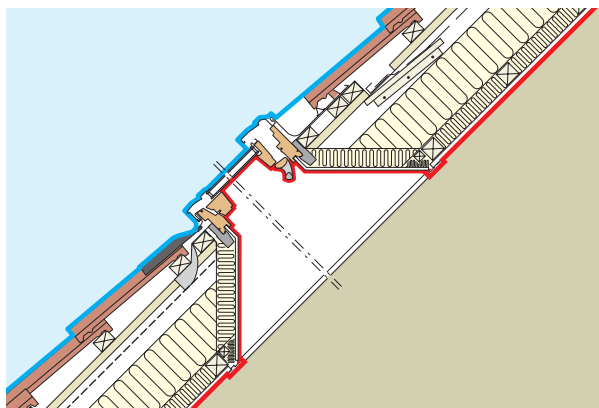

The roofing material makes up the exterior weather shield that is the primary protection against precipitation. If the roofing material, for instance pan tiles without pointing, is not completely tight, an underfelt layer must be established.

Roofing materials are available in a large number of types and materials. However, condensation will form on the underside of all roofing materials and this moisture must be ventilated to the outside.

Therefore there must be a ventilation path under the roofing material. If underfelt has been laid, battens and counter battens form this path.

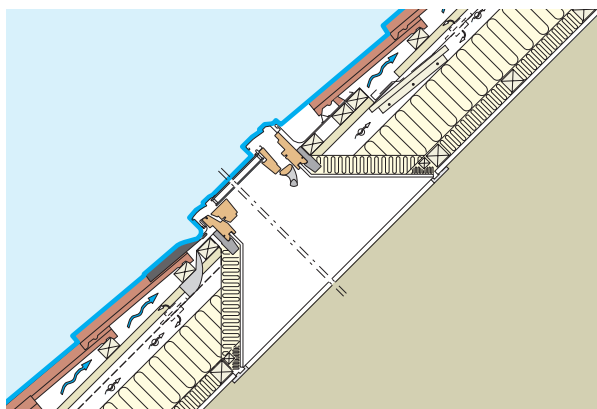

The underfelt protects the roof construction against harmful water penetration, primarily from condensation or leakages through the roofing material. A leakage in the roofing material means that wind driven rain and snow may penetrate the roof constructions. Especially drifting snow may cause problems if there is no underfelt. Large amounts of snow may accumulate over time and suddenly melt when the temperature rises.

Water that runs down the underfelt ends in the gutter. If the underfelt is interrupted by for instance a roof window, the water must be drained off to the sides of the roof window by installing a drainage gutter. The drainage gutter drains off the water to the adjoining roof section (between two trusses) where it can continue down the underfelt.

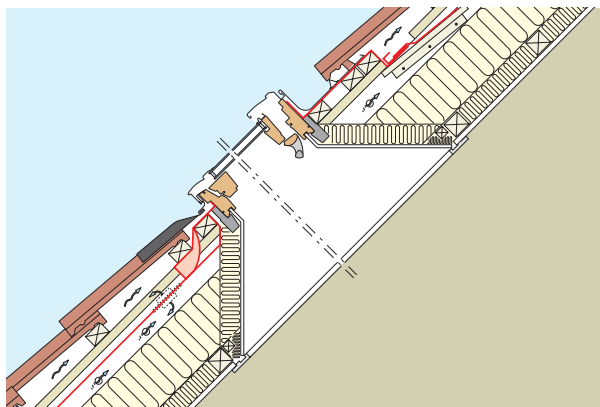
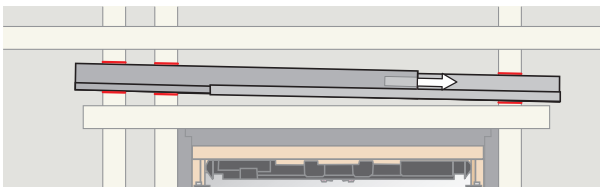

As a result of for instance small holes in the vapour barrier, moisture may enter the roof construction from the inside of the building. This moisture must be removed in order to avoid subsequent problems with rot.

Depending on the means of removing the moisture, underfelts are divided into ventilated and unventilated underfelts.

### VENTILATED UNDERFELTS

Ventilated underfelts are usually made of diffusion tight materials. The moisture is removed from the roof construction as the cavity between insulation and underfelt is ventilated with fresh air.

The air circulation under a ventilated underfelt may be obstructed in one or more roof sections when a roof window is installed. To ensure ventilation in the roof section affected, it is recommended either:

- to fit ventilation pieces in the underfelt material (1) or
- to establish ventilation holes at the top of the rafters (2) so that air can flow to/from the adjoining roof section.

This must be done both above and below the roof window.

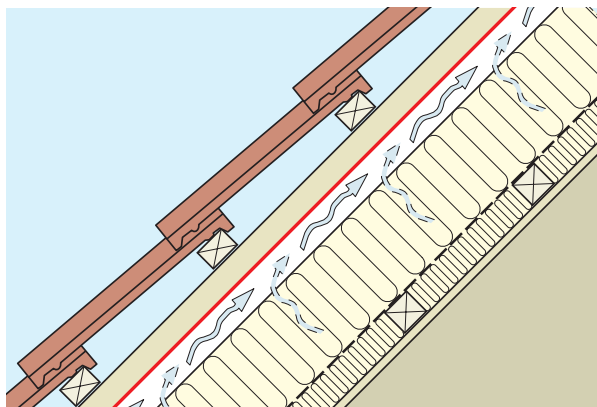
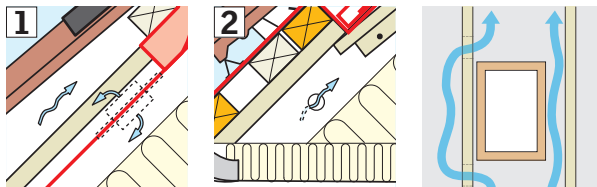

The lack of a ventilation path below the underfelt may result in accumulation of moisture in rafters and insulation material. This may reduce the performance of the insulating layer and cause damages.

### UNVENTILATED UNDERFELTS

Unventilated underfelts are based on diffusion open underfelt materials that are positioned directly on the insulating material. Via diffusion through the vapour barrier, small amounts of moisture percolate from the interior of the building to the roof construction and continue through the underfelt material. From here the moisture is removed by the ventilation under the roofing material.

As diffusion is not nearly as effective as ventilation, it is very important that the vapour barrier is absolutely airtight. The diffusion capacity of the underfelt is not sufficient to compensate for leakages in the vapour barrier.

VELUX underfelt collar BFX is made of diffusion open material and can thus be used for unventilated underfelts. The method for fitting of the underfelt collar is the same when installed in ventilated and unventilated underfelts.

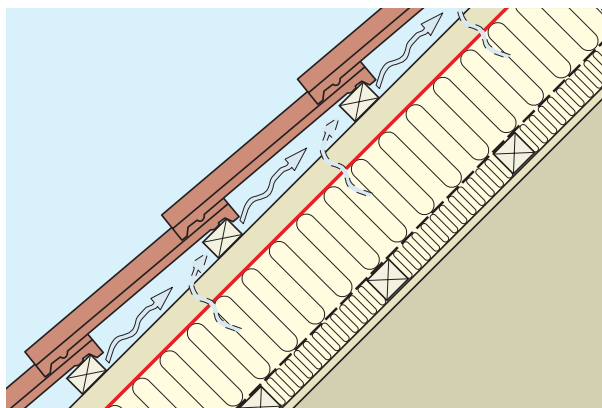

When installing VELUX roof windows, you may choose to make allowances for rafter distances and vertical wall conditions instead of changing the roof construction. However, sometimes the preferred VELUX solution requires adjustment of the roof construction in order to create sufficient space. If planned thoroughly, this is not a problem.

The design of old roof constructions is often based on tradition and experience. Changes to these roof constructions are therefore made on the basis of traditional craftsmanship and experience with a fair share of reason and caution.

In new roof constructions where the bearing elements are often factory-made, the construction systems and materials have been optimised on the basis of calculations. Any change/weakening of the bearing system in these wall and roof constructions may impair the construction beyond calculated permissible safety limits. Factory-made rafters are most often marked with manufacturer and identification and it is recommended to seek advice from the manufacturer or a structural engineer before making changes in such constructions.

The extra time and materials required to ensure that the structural integrity of the roof is maintained can be relatively moderate considering that the roof construction is already accessible.

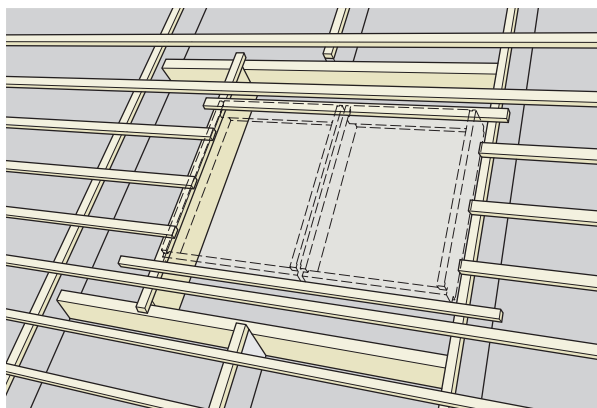

The installation brackets supplied with VELUX roof windows are fixed either to the side frames or to the top and bottom frames. The positioning of the brackets depends on the chosen flashing, for example based on the wish for a standard (red) or recessed (blue) installation level, see page 31.

To place the insulation optimally around the frame, the installation brackets rest on the top face of the battens. The brackets have been designed so that they can always be fastened through the battens to the underlying rafter construction with the long screws supplied. Therefore, there are no specific requirements as to the strength of the battens.

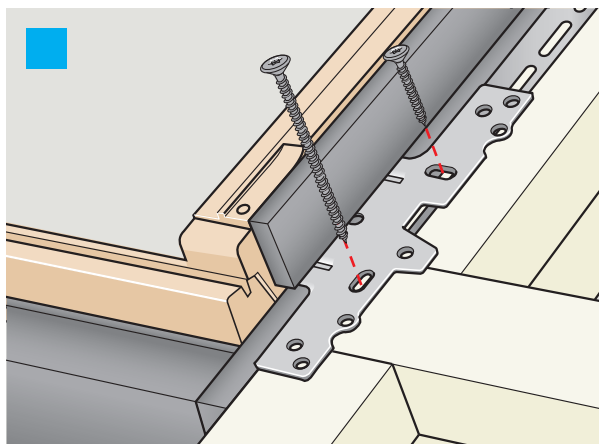
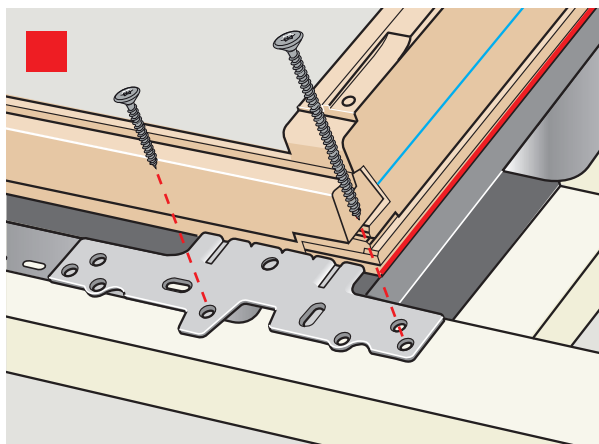

The **U-value** of a building component is an expression of the insulating capacity of this component. The U-value states the amount of energy or heat being emitted from the warm side of a building component to the cold side. The lower the U-value, the less energy or heat will flow through the building component and thus the better the insulating capacity.

The requirements of the building regulations apply to both the total energy consumption of a building and the U-value of the individual building components.

The total energy consumption is calculated on the basis of the U-value of each individual component; for this reason, the U-value of building components is an important factor.

In a VELUX roof window, two components specifically have an influence on the total U-value and the insulating capacity of the roof window.

The **insulating glass unit** accounts for the largest area and therefore it is the most significant building component in terms of U-value. The insulating capacity of the insulating glass unit, expressed as  $U_g[W/m^2K]$ , has a great impact on the comfort in the area close to the roof window as a poorly insulated insulating glass unit will cool the air. The cold air will flow from the insulating glass unit and may result in draught.

The **frame/sash** constitutes the second area and its insulating capacity is expressed as  $U_f[W/m^2K]$ . Because of its construction, the same good U-value as that of the insulating glass unit cannot be obtained and the area therefore risks being seen as a thermal bridge.

Please note, however, it is generally the U-value for the complete roof window, expressed as  $U_w[W/m^2K]$ , that is required for compliance to the building regulations.

Even if the frame and its connection to the roof construction cover a small area only, careful insulation around the frame is essential. Insufficient frame insulation results in lower surface temperatures and thus a risk of condensation on the interior surfaces.

In addition, a VELUX roof window must meet the requirements of the building regulations as to linear heat loss (thermal bridges). Therefore, the frame must be insulated carefully up to the upper side of battens. The required level of insulation can be achieved using VELUX frame insulation collar BDX.

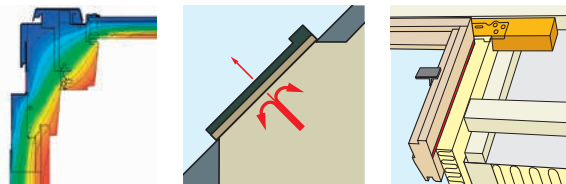

## Building physics

### Solar gain: g-value

The **g-value** of the roof window is just as important as the U-value. The g-value represents the ability of the roof window to let the solar heat into the building, thus contributing to a reduction of the energy consumption for heating in the heating season.

The g-value of the roof window expresses the percentage (as a factor) of the solar heat falling on the window glazing to radiate into the house. The higher factor, the higher solar gain.

During the summer, the solar heat can, however, contribute to excess temperatures in a room. In these cases, consideration to installing exterior sunscreening products should be made in order to be able to control the amount of solar heat to be let into the building.

In terms of the **energy balance** of a roof window, it expresses the difference between the amount of solar heat entering the building (g-value) and the amount of energy or heat that is emitted (U-value).

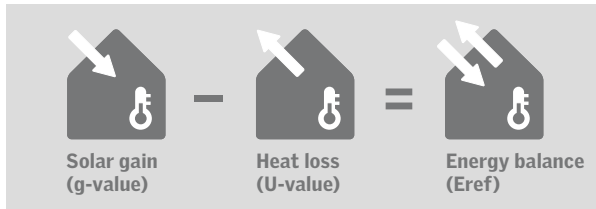

## Building physics

### Vapour barrier

The vapour barrier is a membrane of a diffusion tight material positioned on the warm side of the construction of the house. It prevents vapour from the warm air inside the building from reaching the colder air/surfaces within the wall or roof construction.

If the warm air is not stopped, the vapour will condensate on the cold surfaces, creating ideal conditions for damaging rot to occur. In periods with frost, this could result in accumulation of ice, making matters even worse.

In addition to reducing the strength and lifetime of the building construction, dry rot may also result in an unhealthy indoor climate.

This makes the vapour barrier one of the most important components in the construction of the building!

Therefore, it is very important to the performance and lifetime of the construction that the vapour barrier is fitted correctly, ensuring absolute air tightness. Especially observe that details such as joints, penetrations and connections to other components of the construction are airtight.

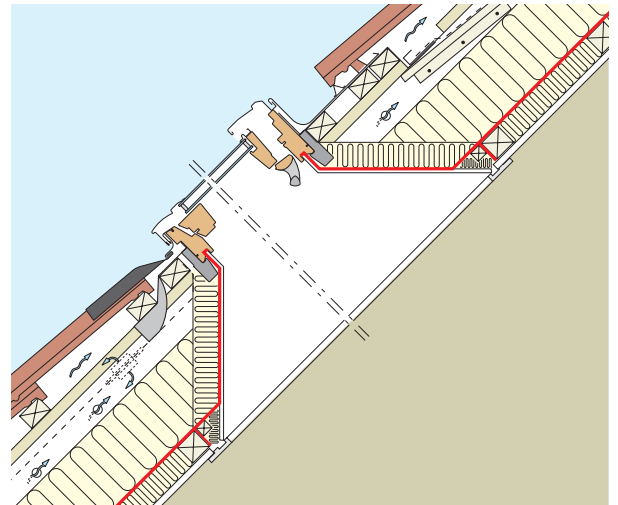

When a VELUX roof window is installed, any vapour barrier present is penetrated. It must be re-established with a membrane that connects the window frame to the vapour barrier within the roof/wall construction.

VELUX vapour barrier collar BBX is the easiest solution and will also provide the necessary airtight seal between the roof window and roof construction.

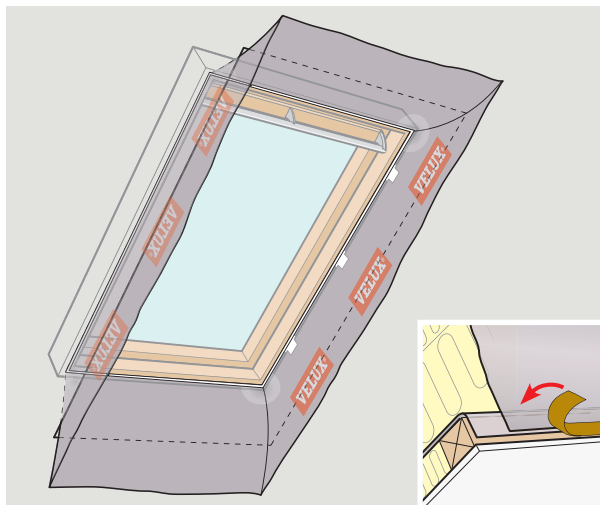

If the membrane used is not a VELUX vapour barrier collar BBX, this membrane must be connected to the window rebate at the frame with butyl or other appropriate sealant to ensure tightness. Where the window aperture meets the interior ceiling, the membrane must be connected to the vapour barrier of the house by means of tape and/or tight overlapping joint.

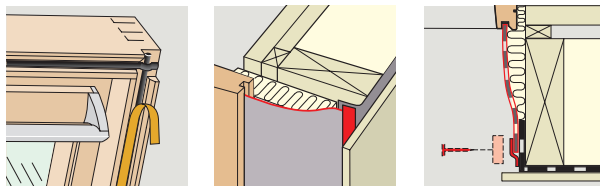

To complete the hole in the roof construction on the interior side, either an on-site lining must be made or a VELUX product can be used, such as VELUX kit for lining LSG or VELUX linings LS-.

The **lining** is of great importance to the performance and to the overall impression of the roof window.

The top should be horizontal and the bottom vertical so that warm air from a heat source below the roof window can keep the inner glazing surface at a higher temperature and help prevent condensation occurring. This shape also allows more light into the room.

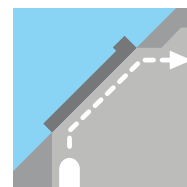

Top and bottom positioned at right angles to the window should be avoided. This would result in cold areas at the bottom of the window, allowing condensation to occur. This would also make the window seem smaller and even impair the view at the head of the roof window.



Note that the colour of the lining has an influence on the amount of light reflected from the lining into the room. The lighter the colour, the more daylight is reflected.

VELUX **products** are, of course, designed to meet these requirements. In addition, VELUX linings offer further advantages that cannot be obtained with an on-site lining solution:

The design of VELUX products allow for more insulation (a).

VELUX linings LS- are fitted directly in the window rebate. It is not necessary to provide additional framing for the lining.

VELUX linings LS- are factory finished and further treatment is not required.

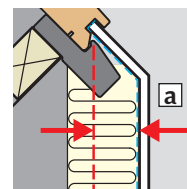



## Building physics

### Ventilation of habitable rooms

A family of 2 adults and 2 children generates moisture equal to approx 10 l of water a day, ie the air inside building accumulates an additional 10 l of water vapour. This will result in an increase in the level of humidity if the air inside building is not renewed.

A high level of humidity creates mould and mould fungus, which can cause both health problems and damage to building components. Therefore, to comply with building regulations, a minimum of air renewal must be provided in dwellings to maintain a good indoor climate and reduce the effects of moisture on the construction of the house. As a rule of thumb, the indoor relative humidity should be below 45% during most months of the year.

Of course, the influences of pollutants and moisture differ from dwelling to dwelling. By complying with the building regulation requirements and observing the following general guidelines, it will in most cases be possible to maintain a low level of humidity.

- It is recommended to air habitable rooms 3-4 times a day, each time for 5-7 minutes.
- Rooms with high levels of humidity such as kitchens and bathrooms should also be provided with mechanical air extraction.
- Heating should not be turned off during airing as the cold fresh air should be heated immediately after the roof windows have been closed again.
- Rooms should not remain unheated for long periods of time as this results in an elevated level of the relative humidity. If the bedroom is kept cold at night, it should be re-heated during the day.
- Avoid drying laundry indoors.

When airing briefly, walls and furniture are not cooled off and consequently the heat loss is minimal.



## Building physics

### Sound insulation

In buildings sound spreads from room to room and from the outside to the inside in two different ways; partly as airborne sound where air pressure waves spread through crevices in the constructions and partly as structural sound that is transmitted via vibrations in solid materials.

The airborne sound can be reduced by carefully sealing crevices in the construction. Structural sound can be diminished by separating the constructions or by using high density building materials.

If there are special requirements as to sound insulation, the special VELUX sound reducing roof windows GGL/GGU --62 or GPU --62 can be used. The construction of this variant has been optimised with regard to sound insulation.

In addition to this, the installation must be carried out so that the connection between the roof window and the roof construction ensures effective sound insulation.

This may be ensured by:

- fitting infill battens along the window frame (a),
- fitting strips of heavy bituminous roofing felt under the underfelt collar (b),
- sealing connections through which airborne sound may pass (c) and
- ensuring that the gaskets fit tightly.

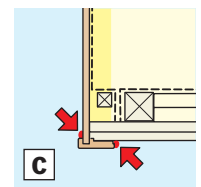
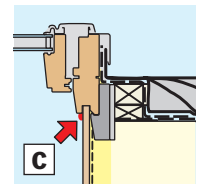
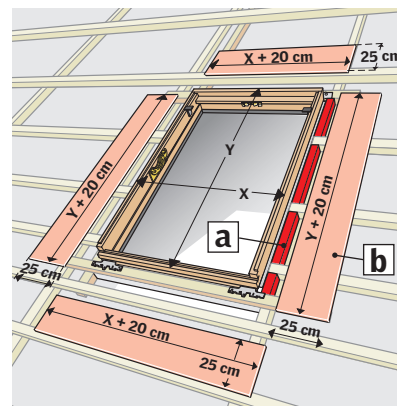

## WINTER CONDITIONS

In areas with heavy snowfall and prolonged cold periods, considerable amounts of snow may accumulate on the roof and a VELUX roof window could become covered during the winter.

Thick layers of snow have an insulating effect and can result in melting the snow closest to the roof surface. This may also take place if heat from the building flows up through the roof construction by a penetration, for instance a chimney or a badly fitted vapour barrier, or because of the small extra heat loss on and around a roof window.

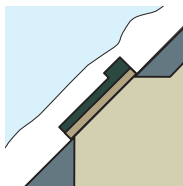

Melting snow will run down the roof surface under the snow cover and once the water reaches a cold surface below 0 °C, it will freeze. This might take place in the area above a cold roof void, the eaves or on the relatively cold roof surface below the roof window.

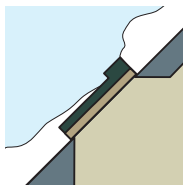

In such cases, a bank of ice can form below the window damming newly melted water. This may cause water ingress around the roof window as neither the window nor the roof surface is designed to resist this.

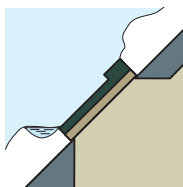

Periods with fluctuating temperatures around freezing point require special attention as a bank of ice can grow very quickly.



**Make sure to remove banks of snow and ice around the roof window so that water can always drain off from the window.**



## IMPORTANT WHEN INSTALLING ROOF WINDOWS IN SNOWY AREAS

It is important to ensure that water on the underfelt does not penetrate the window area and can always drain away from this area.

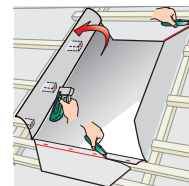

Avoid thermal bridges by insulating carefully around the roof window with for instance VELUX frame insulation collar BDX.

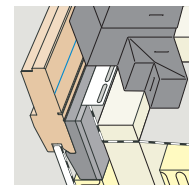

VELUX underfelt collar BFX ensures a tight connection to underfelt. Therefore, the underfelt collar must be shaped carefully around the battens and fixed to the counter battens. In snowy areas, it is recommended to tape the underfelt collar to the roof window with an approved underfelt tape.

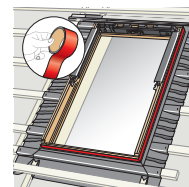

The flashing foam keeps drifting snow and driving rain from the roof constructions. Therefore, the foam must be shaped to fit the roofing material.

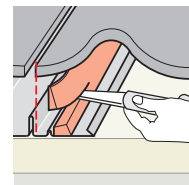

The vapour barrier connection is very important. VELUX vapour barrier collar BBX ensures a tight connection between the window frame and the vapour barrier of the building. In this way moisture cannot escape around the roof window and condensate in the roof construction.

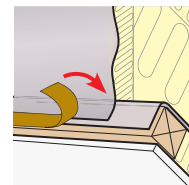

## Building physics

### Snow and ice on and around VELUX roof windows

#### USE OF ROOF WINDOWS DURING THE WINTER

In prolonged cold periods, the ventilation flap should be kept closed. If the ventilation flap is open, the warm air inside building will flow out and melt the snow above the roof window. The melted snow will freeze on the window covers and make the window difficult to open.

If you want to air the room, the window must therefore be opened briefly, see page 128.

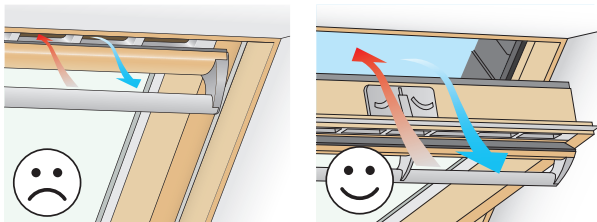

Even without snow on the roof, water may drip from an open ventilation flap in cold periods. This may take place when warm, moist air inside building meets extremely cold fresh air. In these situations, the ventilation flap should be kept closed, too. If you want to air the room, you are instead advised to open the window.

During changes of weather in the autumn and spring, the risk of condensation is increased.

## Building physics

### Snow and ice on and around VELUX roof windows

#### POSITIONING OF THE WINDOW IN THE ROOF SURFACE

When installing roof windows in snowy areas, special attention must be paid to the positioning of the window in the roof.

In case of roofs at split-levels or displacements of the roof ridge, large accumulations of drifting snow may occur even if there is only little snow. The same phenomenon can be seen by obstacles to wind flow such as chimneys and by top flashing sections. Therefore, avoid wherever possible positioning of roof windows in places that pose a risk of accumulation of drifting snow.

If possible, place snow stops at some distance from roof windows. Snow stops retain the snow with the risk of forming a bank of ice or snow right below the window. Such a bank would dam up additional melting water from the window.

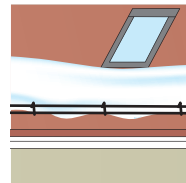
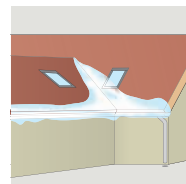

#### SNOW AND SHALLOW ROOF PITCHES

Generally, more snow will settle on roofs with a shallow roof pitch than on roofs with a steeper roof pitch. This may result in more winter maintenance work on and around roof windows as more snow must be removed.

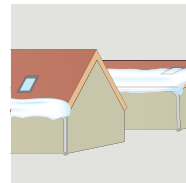

#### COMBINATIONS

When combining roof windows above/below each other in areas with severe weather conditions, rather large banks of ice may be formed under the bottom roof window as a result of melting water from two roof windows. Therefore, this requires somewhat more winter maintenance work. Roof windows combined side by side do not require other measures than a single roof window as the bank of ice will be distributed over a larger area.

## PRODUCTS FOR SNOWY AREAS

To obtain greater resistance to weather conditions during the winter, a number of VELUX products and solutions for particularly snowy areas have been developed.

### Roof window GGU ----IS

In addition to the standard GGU parts, the roof window consists of special gaskets, a special bottom frame cover, sealed screws and a triple glazed insulating glass unit. These components make the roof window more resistant to "dammed up" water and extreme weather conditions. The triple glazed insulating glass unit reduces the possibilities of snow melting on the glazing and therefore decreases the risk of melt water forming a bank of ice below the window.



### Retrofitting kit ZIS

This kit can be retrofitted on an already installed roof window. The kit consists of gaskets, a special bottom frame cover and sealed screws. These components make the roof window more resistant to "dammed up" water and extreme weather conditions.

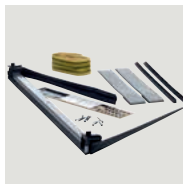

### Replacement glazing kit IGR

The kit is used to upgrade a double glazed to a triple glazed insulating glass unit. It consists of the components necessary for the replacement except for the triple glazed insulating glass unit that must be ordered separately. A triple glazed insulating glass unit reduces the possibilities of snow melting on the glazing and therefore decreases the risk of melt water forming a bank of ice below the roof window.



## Heating cables

Heating cables make the winter maintenance work easier. Please note that even if heating cables ensure that melting water is drained off the roof windows, snow and ice may still have to be removed from the windows.

The principle of laying heating cables is shown in the illustration. They must be led to frost-proof depth to ensure that the melting water can drain off.

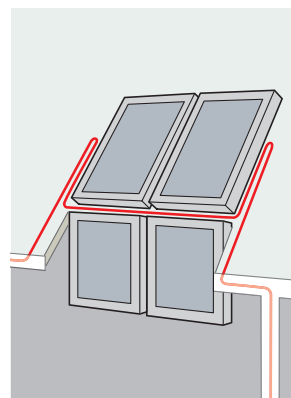
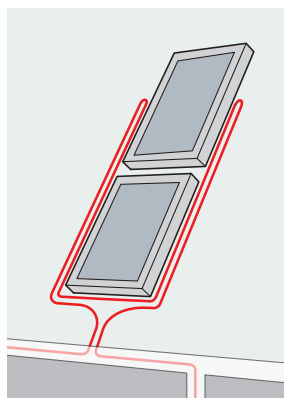
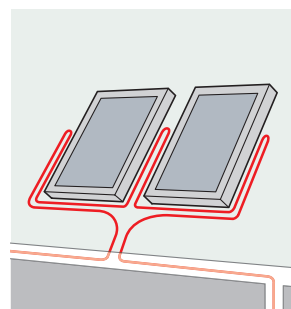
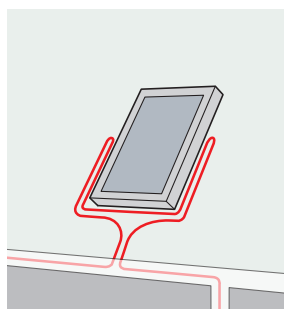

<b>Product types</b>	<b>138</b>
<b>VELUX product and order codes</b>	<b>139-140</b>
<b>VELUX roof windows</b>	<b>141</b>
<b>Centre-pivot roof windows / Top-hung roof windows</b>	<b>142</b>
<b>VELUX INTEGRA® roof windows</b>	<b>143</b>
<b>Roof balcony</b>	<b>144</b>
<b>Roof terrace</b>	<b>145</b>
<b>Smoke ventilation windows</b>	<b>146</b>
<b>Sound reducing roof windows</b>	<b>147</b>
<b>Additional elements</b>	<b>148</b>
<b>Vertical window elements</b>	<b>149</b>
<b>Installation products</b>	<b>150-151</b>
<b>Linings</b>	<b>152-153</b>
<b>Electrical operation</b>	<b>154-155</b>
<b>Sunscreening products</b>	<b>156-157</b>
<b>Insulating glass units</b>	<b>158-161</b>

## Product information

### Product types

The VELUX roof window is the key product in the VELUX product programme for sloping roofs.

But in addition to this, a wide range of different VELUX product types is offered that together ensure correct installation and optimum functionality of the roof window in all situations.

This chapter describes the various product types.

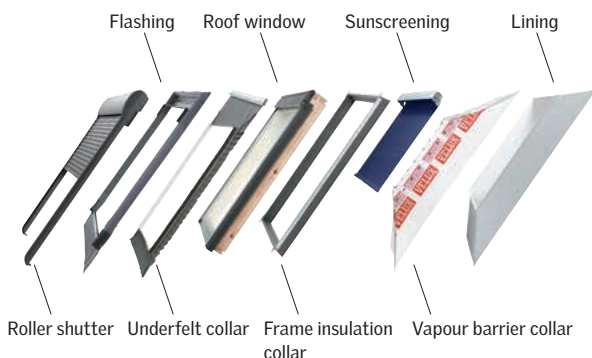

In order to comply with customer demands in the best possible way, the VELUX products are available in many different standard sizes and variants.

To be able to handle and describe this product system in a simple way, product codes with eleven characters divided into three "blocks" are applied.

Examples:

<b>Type designation</b>	<b>GGL</b>	<b>EDW</b>
<b>Size code</b>	<b>MK08</b>	<b>MK08</b>
<b>Variant code</b>	<b>3059</b>	<b>2000</b>

## Product information

### VELUX product and order codes

#### TYPE DESIGNATION

The first three characters in the product code of any VELUX product is the type designation.

The first letter in the type designation indicates the product family. Below some examples:

**G--** indicates a roof window, eg **GGL**

**E--** indicates a flashing, eg **EDW**

**B--** indicates an installation product, eg **BDX**

**L--** indicates a lining, eg **LSB**

**S--** indicates a roller shutter, eg **SML**

#### SIZE CODE

The second block consisting of two letters and two digits indicates the size of the product. The size code of the roof window indicates the exterior frame dimensions where the letters stand for the width and the digits stand for the height.

For instance **CK04** = 550 x 980 mm (w x h)

**MK08** = 780 x 1400 mm (w x h)

Please refer to VELUX size chart, see page 181.

The size code of other products indicates which window size the product matches.

**Note:** Not all sizes are marketed but they can be obtained on order.

#### VARIANT CODE

Most products are available in various materials and with various surfaces. Window covers and flashings that are made of aluminium as standard are also available in copper and zinc. Insulating glass units are available with special qualities etc.

The four digits in the variant code define the different types of materials and surfaces.

**Note:** Possible variants appear within the various sales brochures and on [www.velux.co.uk](http://www.velux.co.uk) or [www.velux.ie](http://www.velux.ie).

## Product information

### VELUX product and order codes

#### DATA PLATE

All VELUX roof windows are equipped with a data plate with precise information about the window. On roof windows with control bar, the data plate is placed on the top sash behind the ventilation flap.



When ordering for instance an insulating glass unit, spare parts or accessories, state all information from the data plate. This ensures delivery of the correct product when ordering.

- ① Type designation
- ② Size code
- ③ Variant code
- ④ Production code

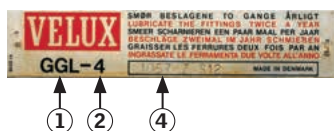
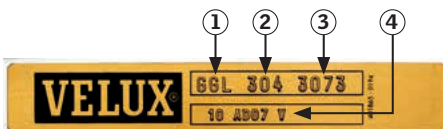
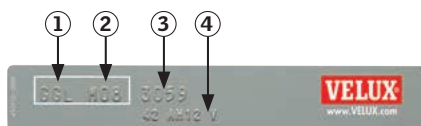
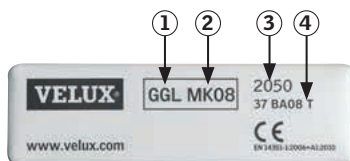

## Product information

### VELUX roof windows



VELUX roof windows are available as centre-pivot roof windows with the type designations GGL and GGU and as top-hung roof windows with the type designations GPL and GPU.

Roof windows with a type designation ending in --L, as for instance GGL, are traditional timber windows. Roof windows with a type designation ending in --U, as for instance GGU, are polyurethane windows with a timber core. Polyurethane windows are especially suited for rooms with a high level of humidity.

The range of VELUX roof windows also includes roof balcony CABRIO® GDL, roof terrace GEL+VEA/VEB/VEC and roof windows with special characteristics and application areas such as smoke ventilation windows.



Roof balcony

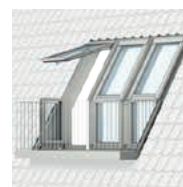

Roof terrace

All VELUX roof windows can be installed individually as well as in combinations side by side and/or over/under each other (see chapter 3).



## Product information

### Centre-pivot roof windows / Top-hung roof windows



#### GGL – timber window

#### GGU – polyurethane window

Characteristics:

- Can be installed in roof pitches from 15° to 90°
- Can be opened/closed with the control bar at the top
- Features ventilation flap and air filter



#### GPL – timber window

#### GPU – polyurethane window

Characteristics:

- Can be installed in roof pitches from 15° to 55° (with special springs up to 75°)
- Can be opened and closed with a handle at the bottom
- Features ventilation flap and air filter
- Can remain open in all positions up to 45°

## Product information

### VELUX INTEGRA® roof windows



#### VELUX INTEGRA® GGL – timber window

#### VELUX INTEGRA® GGU – polyurethane window

Characteristics:

- Mains-powered variants of GGL/GGU delivered with integral motor and control
- Operated with wireless control pad based on io-homecontrol® technology (see page 154). Can also be operated manually
- Integrated rain sensor
- Prepared for subsequent fitting of mains-powered sunscreening products

Apart from the above, the roof windows have the same characteristics as GGL/GGU.



#### VELUX INTEGRA® Solar GGL – timber window

#### VELUX INTEGRA® Solar GGU – polyurethane window

Characteristics:

- Solar-powered variants of GGL/GGU delivered with integral motor and control. Wireless installation
- Operated with wireless control pad based on io-homecontrol® technology (see page 154). Can also be operated manually
- Integrated rain sensor
- Can be combined with a broad range of solar-powered suncreening products

Apart from the above, the roof windows have the same characteristics as GGL/GGU.



## Product information

### Roof balcony



#### CABRIO® GDL – roof balcony

Characteristics:

- Can be installed in roof pitches from 35° to 53°
- The top-hung upper section
  - is opened and closed with a handle at the bottom
  - can remain open in all positions up to 45°
  - features ventilation flap and air filter
- The bottom-hung lower section
  - is opened and closed with two handles on the top sash
  - has integral banisters that automatically slide into position
- Is only available in timber version

When installed in combination with other roof windows, please contact VELUX Company Ltd.

## Product information

### Roof terrace

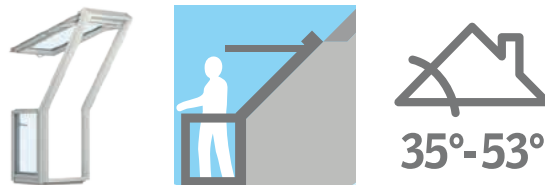

**GEL – upper section:** top-hung roof window

**VEA – lower section:** outward opening sash, hinged on the left hand side (seen from the outside)

**VEB – lower section:** outward opening sash, hinged on the right hand side (seen from the outside)

**VEC – lower section:** fixed sash (non opening)

VELUX roof terrace is a combination of upper and lower sections which when opened allow access to a roof terrace. Because of structural considerations, a roof terrace can contain only one opening lower section VEA/VEB.

The terrace floor and railing are not VELUX products.

Characteristics:

- Can be installed in roof pitches from 35° to 53°
- The upper section
  - is opened/closed with a handle at the bottom
  - can remain open in all positions up to 45°
  - features ventilation flap and air filter
- Lower sections VEA/VEB can be opened/closed with a handle on the side sash
- When both upper and lower sections are open, there is free access to the roof terrace
- Can be installed using adjustable support rafter EBY W10
- Is only available in timber version

When installed in combination with other roof windows, please contact VELUX Company Ltd.

## Product information

### Smoke ventilation windows



#### **GGL ----40 – smoke ventilation window (timber)**

#### **GGU ----40 – smoke ventilation window (polyurethane)**

Characteristics:

- Can be installed and used for venting of smoke in roof pitches from 15° to 60°
- Optimised geometric and aerodynamic venting area
- Is to be connected to VELUX control system KFX/KFC and can control up to 2 smoke ventilation windows
- Certified according to EN 12101-2
- The smoke ventilation window can be used for comfort ventilation but is not compatible with io-homecontrol®

## Product information

### Sound reducing roof windows

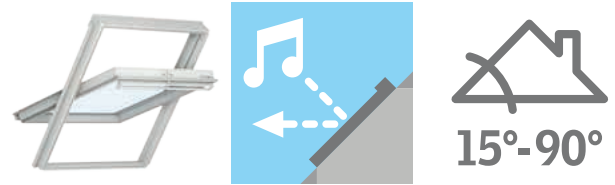

#### **GGL --62 – sound reducing roof window (timber)**

#### **GGU --62 – sound reducing roof window (polyurethane)**

Characteristics:

- Can be installed in roof pitches from 15° to 90°
- Provides sound reduction of 42 dB
- Apart from the above, the roof windows have the same characteristics as GGL/GGU

The sound reducing roof window is also available as top-hung polyurethane window GPU --62, which apart from sound reduction has the same characteristics as GPU.

## Product information

### Additional elements



#### **GIL – timber window**

#### **GIU – polyurethane window**

Characteristics:

- Rectangular lower element with fixed sash (non opening)
- Can be installed in roof pitches from 15° to 90°
- Can only be installed below a VELUX roof window
- Is to be installed frame-to-frame with the roof window above

## Product information

### Vertical window elements



#### **VFE – timber window**

Characteristics:

- Has bottom-hung, inward opening sash
- Can be opened and closed with a handle on the top sash
- Is to be installed vertically below a VELUX roof window installed in a roof pitch between 15° and 55°

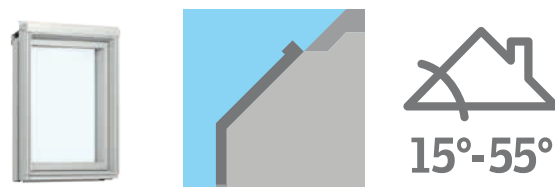

#### **VIU – polyurethane window**

Characteristics:

- Has fixed sash (non opening)
- Is to be installed vertically below a VELUX roof window installed in a roof pitch between 15° and 55°

## Product information

### Installation products

VELUX installation products ensure connection to the underlying layers that are typically present in a roof construction, ie underfelt, wind tight layer, insulation and vapour barrier, see chapter 7.

#### BDX 2000

Installation set consisting of frame insulation collar **BDX**, underfelt collar **BFX** and drainage gutter as shown below, see also pages 19, 21.

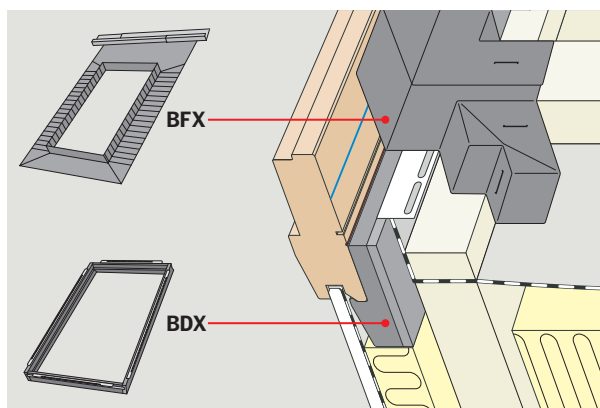

#### BDX

The frame insulation collar consists of shaped polyethylene insulation in a stable steel frame. The collar is positioned in the hole in the roof before the VELUX roof window is installed. This ensures an effective insulation around the frame.

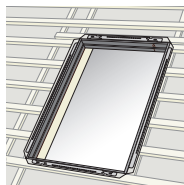

#### BFX

Underfelt collar of diffusion open material with pleated sides that are shaped around the battens and protect against rain and snow.

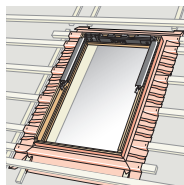

## Product information

### Installation products

#### ZZZ 196

Wind tightness set used with installation set BDX 2000 to meet stringent requirements as to wind tight installation. The set consists of pleated corner pieces and butyl for wind proofing of the corners when the existing underfelt is folded.

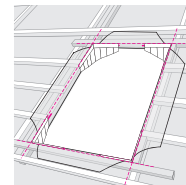

#### BBX

Polyethylene vapour barrier collar. Fitted in the window rebate and led to the interior ceiling/wall where it is connected to the vapour barrier of the roof/wall with tape supplied. The vapour barrier collar is also supplied with lining LS- and kit for lining LSG.

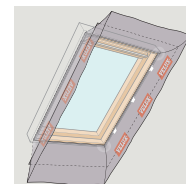

#### EBY/EKY

Support rafter of laminated wood (finished with clear lacquer or white foil) provides support and interior finish between roof windows installed side by side with a frame distance of 18 mm (EBY) or 100 mm (EKY). See chapter 3.

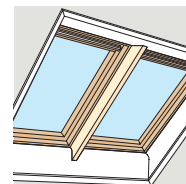

#### EBY W10

Adjustable support rafter of laminated wood (finished with clear lacquer or white foil). Used for installation of combinations of roof window/vertical window elements VFE/VIU or for roof terrace GEL.

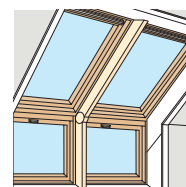

#### LGI

Frame extension of laminated wood finished with clear lacquer or white paint to match the roof window. Fitted from the inside once the window has been installed.

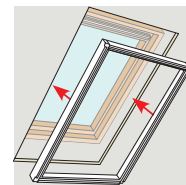

If the installation does not include a VELUX lining, the frame extension can also be used to ensure sufficient space for insulation in the roof void above and below the window.

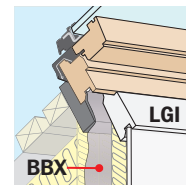

## Product information

### Linings

VELUX linings ensure an easy and quick connection of the roof window to the interior ceiling finish. The white, semi gloss surface and the white facings supplied ensure a harmonious connection from the roof window to most walls.

#### LSB/LSC/LSD

Standard linings to be used in roofs with a thickness of 125 mm to 500 mm and in roof pitches from 15° to 90°.

In roof pitches from 30° to 60°, it is possible to install lining with horizontal top and vertical bottom. The linings are fitted and secured in the window rebate and there is no need for further framing.

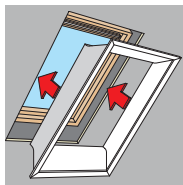

#### LEI

Vertical wall element to be fitted with linings LSB/LSC/LSD in roof pitches from 30° to 60°.

The supplementary kit consists of additional side sections and a window sill for installation in vertical wall. The sill depth is max 500 mm.

See page 69.

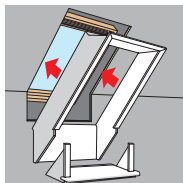

#### LVI

Supplementary lining to be fitted with linings LSB/LSC/LSD in roof pitches from 30° to 55°.

The supplementary kit is used for combinations with a roof window above a vertical window element.

The supplementary kit consists of extra side sections and a window sill. The sill depth is max 300 mm.

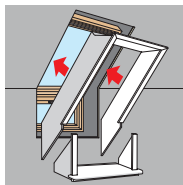

## Product information

### Linings

#### LFI

Window sill to be fitted in linings LSB/LSC/LSD.

The sill is fixed to the bottom lining section. The sill depth is 270 mm.

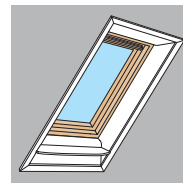

#### LLB/LLC/LLD

Additional side sections to be fitted with linings LSB/LSC/LSD.

The supplementary kit is used for combinations of a roof window with an additional element GIL/GIU as well as for roof balcony CABRIO® GDL.

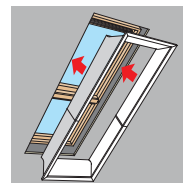

#### SPECIAL PRODUCTS

Linings are also available for twin installations with 18 mm and 100 mm frame distance.

These linings must be ordered as special products.

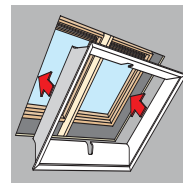

#### LSG

Kit for lining as a framing basis for lining panels made of the materials on-site. The framing can be used for roof depths between 220 mm and 700 mm in all roof pitches.

When purchasing extension pieces, the kit can be used for light shafts.

Vapour barrier collar BBX is supplied with the kit.

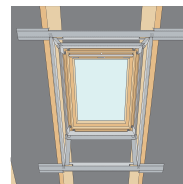

#### VELUX INTEGRA® KRA 100

Frame lights for VELUX linings. The spotlights are fitted in the upper lining and connected to mains-powered roof windows. Light intensity can be regulated via window control pad.

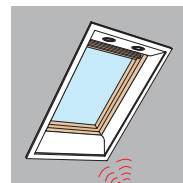

## Product information

Electrical operation – VELUX INTEGRA® products

### INSTALLATION OF ROOF WINDOWS

VELUX INTEGRA® roof windows (see page 143) are installed in the same way as standard centre-pivot roof windows and just have to be connected to a standard plug outlet or mains supply. If the wiring from window to power supply is difficult, VELUX INTEGRA® Solar roof windows may be an option. They do not require any wiring and receive power through an integrated solar cell.

VELUX INTEGRA® products ensure optimum operational possibilities in terms of comfort and indoor climate.

With a range of easy to use pre-installed programs, VELUX INTEGRA® control pad KLR 200 can provide maximum performance from the products. For instance, you can use the program "Good morning" as an alarm clock. It will raise the sunscreening products and open the windows at the time set by yourself.

All products are based on wireless operation (io-homecontrol® technology) and therefore they can be operated from anywhere in the building with one and the same control.



### UPGRADING EXISTING ROOF WINDOWS

If a manually operated roof window GGL/GGU, manufactured from April 2012 and later, was prepared for electrical operation at the time of installation (by running cables, see page 26), you can retrofit VELUX INTEGRA® conversion kit KMX 110K which includes control pad KLR 200.

If you want to avoid wiring entirely, you can use VELUX INTEGRA® Solar conversion kit KSX 100K, which receives power through an integrated solar cell.

Similar solutions are available for manually operated roof windows GGL/GGU and GPL/GPU manufactured before February 2014. Please identify the window size code on the data plate, see page 140, and contact VELUX Company Ltd or visit [www.velux.co.uk](http://www.velux.co.uk) or [www.velux.ie](http://www.velux.ie) for further information.

## Product information

Electrical operation – VELUX INTEGRA® products

### For roof windows manufactured between April 1986 and January 2014

VELUX INTEGRA®  
KMX 100



VELUX INTEGRA®  
Solar KSX 100



### For roof windows manufactured from February 2014 and later

VELUX INTEGRA®  
KMX 110K



VELUX INTEGRA®  
Solar KSX 100K



VELUX INTEGRA® products can be part of other intelligent building management installations such as IHC systems; please contact VELUX Company Ltd.

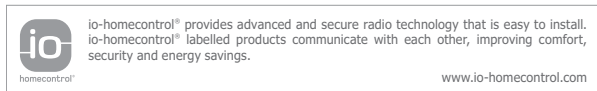

## Product information

### Sunscreening products

VELUX roof windows are prepared for fitting of original VELUX interior or exterior sunscreening products such as blackout blinds and roller shutters. The products are designed so that fitting is both easy and quick. They are available with manual operation and in mains- or solar-powered versions (pleated and Venetian blinds are not available in solar-powered versions).

For further product information, visit [www.velux.co.uk](http://www.velux.co.uk) or [www.velux.ie](http://www.velux.ie) where the VELUX blinds collection brochure may be viewed and ordered.

#### PLEATED BLINDS

Provide privacy and a soft diffused light in the room.

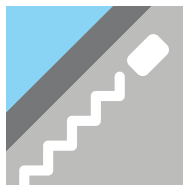

#### VENETIAN BLINDS

Control the amount and direction of light entering the room and protect against heat.



#### ROLLER BLINDS

Provide privacy and a soft light in the room.



#### BLACKOUT ENERGY BLINDS

Provide complete blackout and effective insulation.

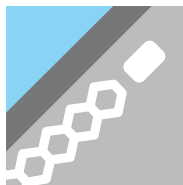

## Product information

### Sunscreening products

#### BLACKOUT BLINDS

Provide complete blackout and reduce both influx and radiation of heat.



#### INSECT ROLLER SCREEN

Keeps out insects but allows ventilation. Manual operation only.

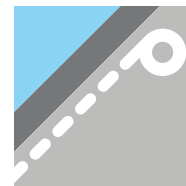

#### AWNING BLINDS

Prevent direct sunlight from reaching the insulating glass unit keeping rooms cool while at the same time allowing a certain view to the outside.



#### ROLLER SHUTTERS

Provide additional security, effective blackout and heat and noise reduction from the outside plus additional thermal insulation.

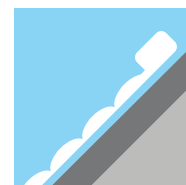

## Product information

### Insulating glass units

The two last figures in the variant code indicate which type of insulating glass unit is fitted in the roof window (eg GGL MK08 3050).

The VELUX Group offers different types of insulating glass units for different purposes. The most commonly used insulating glass units are described below. If other types of insulating glass units are required, please contact VELUX Company Ltd.

#### 16 MM REPLACEMENT GLAZING (--59C)

16 mm insulating glass unit used for obtaining a better insulating value when replacing the pane in old roof windows manufactured before 2001. It is an alternative to upgrading to a 24 mm insulating glass unit by means of replacement glazing kit IGR. The unit comes with a toughened outer pane making the glazing more resistant to hail, wind and snow.



#### STANDARD ENERGY GLAZING (--50)

As standard, VELUX roof windows are supplied with a 24 mm low energy insulating glass unit with heat insulating coating and gas filled cavity in order to better utilize the solar heat. The unit comes with a toughened outer pane making the glazing more resistant to hail, wind and snow.

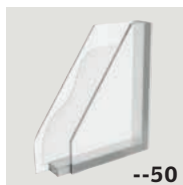

#### STANDARD LAMINATED GLAZING (--70)

In addition to the features described for standard energy glazing above (variant --50), this insulating glass unit comes with an inner pane of laminated glass for enhanced personal safety, UV protection against premature fading of furniture and improved sound reduction.



## Product information

### Insulating glass units

#### NOISE REDUCTION GLAZING (--60)

This insulating glass unit combines all of the characteristics of variant --70 but with an additionally improved sound insulation, rain noise reduction, solar heat protection and an outer coating which helps the window stay cleaner for longer.

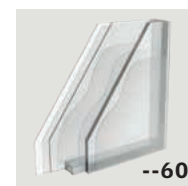

#### LOW ENERGY GLAZING (--66)

This 37 mm gas filled low energy glass unit is triple glazed with insulating coating. In addition to the extra heat insulation, this insulating glass unit has extra sound reduction and coatings that decrease the risk of dew forming on the outer pane surface and help the window stay cleaner for longer.



#### EXTRA SOUND INSULATING GLAZING (--62)

This insulating glass unit is used if additionally improved sound insulation is needed. The low energy glass unit is triple glazed with heat insulating coating and sound insulating foil ensuring better energy efficiency and high sound reduction. In addition, the glass unit has a coating that decreases the risk of dew forming on the outer pane surface. Roof windows with glazing variant --62 also provides rain noise reduction.

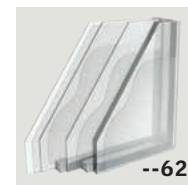



## Product information

### Insulating glass units

#### SECURITY GLAZING (--70Q)

In addition to the features described for standard laminated glazing above (variant --70), this insulating glass unit comes with a higher safety class on the inner laminated glass for resistance to burglary (security class P4A according to EN 356). Roof windows with glazing variant --70Q provides resistance to burglary class 2 according to EN 1627:2011 and NEN 5096.

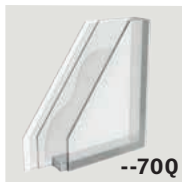

#### OBSCURE GLAZING (--34)

This insulating glass unit is recommended for bathrooms and where privacy is required. A white foil in the inner laminated glass provides privacy while still providing a high level of natural daylight.

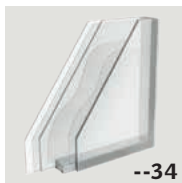

#### HANDLING AND CLEANING PANES

To protect the coatings on the outer surface of the pane, avoid any contact from silicone or sharp and abrasive objects. Never attempt to clean dirt off the pane without first applying water. If any works are taking place in the vicinity of the pane, protect the pane with a clean plastic sheet to prevent any splashes or staining from aggressive and abrasive compounds or for instance plywood if the works result in the production of sparks or hot particles.

Clean water will normally be sufficient for cleaning the pane. Ordinary, non-abrasive household cleaners can also be used. Do not use household cleaners containing high levels of acid or alkaline for cleaning the pane.

#### LAMINATED GLASS

Insulating glass units with laminated glass on the inside are recommended for roof windows installed at high level. Laminated glass consists of two or more layers of glass with a plastic foil (PVB) between. If the glass shatters, the glass is retained by the foil.

Insulating glass units --70, --60, --66, --62, --34 and --70Q have laminated inner glass.

## Product information

### Insulating glass units

#### CLEAR AND CLEAN COATING

Activated by the UV rays of the sun, an invisible coating on the outer pane surface breaks down and loosens organic dirt, which is then simply washed away by the rain, thereby reducing the need to clean the window.

Glazing with the clear and clean coating is recommended for roof windows installed out of reach. The actual position of the window in combination with the weather may influence the effect.

Insulating glass units --60 and --66 have the clear and clean coating.

#### ANTI DEW COATING

Low energy insulating glass units have a colder outer pane surface because of their extra heat insulation properties. This can result in an increased risk of dew forming on the outer pane surface – especially during the autumn and spring months. The invisible anti dew coating on the outer pane surface ensures that dew formation is reduced and that dew vanishes more quickly.

Insulating glass units --62 and --66 have the anti dew coating.

#### ANTI DEW PLUS CLEAR AND CLEAN COATING

A coating on the outer pane surface combines the characteristics of both the clear and clean coating and the anti dew coating.

Insulating glass unit --66 has this coating.

## Other products

### Other VELUX products for sloping roofs

---

**Rooflights with integrated flashing** 164-165

---

**Sun tunnels** 166-167

---

## Other products

### Rooflights with integrated flashing

Rooflights with integrated flashing are small window units for special situations.

The window types below are delivered and installed as one unit. The rooflights cannot be combined with other windows.

#### GVT – side-hung rooflight

Characteristics:

- For uninhabited attics
- Can be installed in roof pitches from 20° to 65°



## Other products

### Rooflights with integrated flashing

#### GVK – side-hung rooflight

Characteristics:

- For uninhabited attics
- Can be installed in roof pitches from 20° to 65°

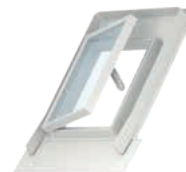

## Other products

### Sun tunnels

VELUX sun tunnels are complete installation kits delivered with all necessary components for both exterior and interior connections. An installation kit consists of three components:

- Exterior rooflight module
- Tunnel (flexible or rigid)
- Interior light diffuser unit

The sun tunnel directs daylight into areas of the house where installation of VELUX roof windows is either not possible or not appropriate. It is recommended for corridors, storage rooms, bathrooms etc.

Installation of a sun tunnel requires access to the attic and roof.

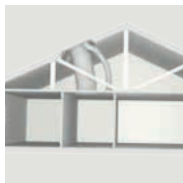

### ROOFLIGHT MODULE

**TLF/TLR** for flat roofing materials such as slates, roof pitch 15°-60°. 4 mm toughened pane and integral flashing made of lacquered aluminium.

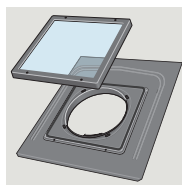

**TWF/TWR** for profiled roofing materials, roof pitch 15°-60°. 4 mm toughened pane and integral flashing made of polyurethane.

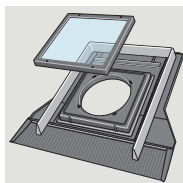

## Other products

### Sun tunnels

#### TUNNEL

Two tunnel types are available:

- A flexible fibreglass tunnel with a highly reflective surface (TLF and TWF). Available in size
  - OK14 (Ø 350 mm/14")
- A rigid aluminium tunnel with a highly reflective coating (TLR and TWR). The rigid tunnel can be extended with extension section ZTR in lengths of 600 mm or 1200 mm up to a maximum of 6.0 m. Available in two sizes:
  - OK10 (Ø 250 mm/10")
  - OK14 (Ø 350 mm/14")

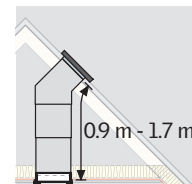
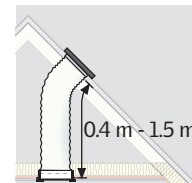

**Note:** To prevent condensation problems, the vapour barrier (a) must always be connected to the light diffuser unit at ceiling level, regardless of the construction.

**Note:** When a tunnel penetrates a 30 minutes fire resistant construction or the like, the tunnel must be made fireproof to avoid fire spread. This might be done by insulating the tunnel with non-inflammable insulating material (b).

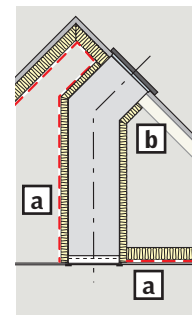

#### LIGHT DIFFUSER UNIT

Seen from the inside, the sun tunnel ends in a frosted light diffuser discretely framed by a white ceiling ring.

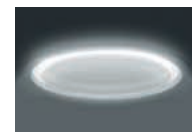

#### Accessories:

- Low U-value kit ZTB (for size OK14 only)
- Light kit ZTL (requires wiring)
- Ventilation outlet ZTV for sun tunnels TWF/TWR. Requires extractor fan and ducting by others
- Underfelt connection BFX
- Blackout blind ZTK



## Other products

### VELUX products for flat roofs

---

**Sun tunnels** **170-171**

---

**Flat roof windows** **172-173**

---

**Modular skylights** **174-175**

---

## Other products

### Sun tunnels for flat roofs

VELUX sun tunnels TCF and TCR are designed for flat roofs with roof pitch 0°-15°.

The sun tunnel directs daylight into areas of the house where installation of VELUX roof windows is either not possible or not appropriate. It is recommended for corridors, storage rooms, bathrooms etc.

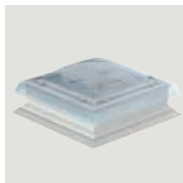

For roof thicknesses between 0.20 and 0.90 m, use sun tunnel **TCF** delivered with a flexible tunnel. For roof thicknesses over 0.90 m, use sun tunnel **TCR** delivered with a rigid tunnel.

VELUX sun tunnels are complete installation kits delivered with all necessary components for both exterior and interior connections. An installation kit consists of three components:

#### • Exterior rooflight module

Made of environmentally friendly PVC, with polycarbonate dome. The module is flashed with the roofing material.

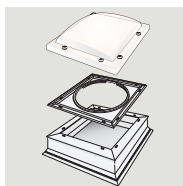

#### • Tunnel

Two tunnel types are available:

- A flexible fibreglass tunnel (TCF) with a highly reflective surface.
- A rigid aluminium tunnel (TCR) with a highly reflective coating.

Available in size

- OK14 (Ø 350 mm/14")

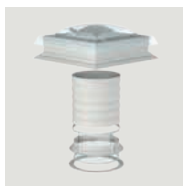

#### • Interior light diffuser unit

Seen from the inside, the sun tunnel ends in a frosted light diffuser discretely framed by a white ceiling ring.



## Other products

### Sun tunnels for flat roofs

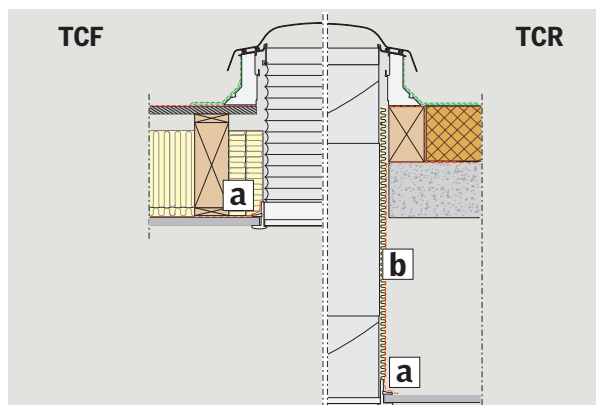

**Note:** To prevent condensation problems, the vapour barrier collar supplied (a) must always be connected to the light diffuser unit at ceiling level.

**Note:** When a tunnel penetrates a 30 minutes fire resistant construction or the like, the tunnel must be made fireproof to avoid fire spread. This might be done by insulating the tunnel with non-flammable insulating material (b).

#### Installation accessories:

- If the installation height needs to be increased, use VELUX extension kerb ZCE 0015. The extension kerb increases the installation height by 160 mm. If the installation height needs to be increased even more, additional extension kerbs can be used on top of each other. In that case, use variant ZCE 1015 (160 mm).
- The rigid tunnel can be extended with extension section ZTR in lengths of 600 mm or 1200 mm up to a maximum of 6.0 m.

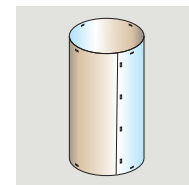
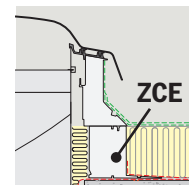

#### Interior accessories:

- Low U-value kit ZTB
- Light kit ZTL (requires wiring)
- Underfelt connection BFX
- Blackout blind ZTK



## Other products

### Flat roof window

VELUX flat roof windows have been designed for installations into flat roofs (0°-15°) with roofing materials such as roofing felt/membranes or preformed metal sheets.

Flat roof windows are available in 9 sizes and can be used for both new and existing roof constructions and replacement of existing dome lights.

When ordering, please note that a flat roof window consists of a **window** and a **dome** which are ordered under one code but delivered as two separate items.

The **window** consists of a combined frame/sash made of white PVC fitted with a low energy glazing. The window is flashed with the same material as the roof covering. The window is available in five types:

- **CVP** with opening sash and remote operation. The motor is integrated in the construction and the system is io-homecontrol® compatible
- **CFP M** with opening sash and manual operation
- **CFP** with fixed (not opening) sash
- **CXP** with opening sash for access to the roof (manually operated)
- **CSP** smoke ventilation window

The **dome** is fitted on top of the window for additional protection, rain noise reduction and rain water drainage. The dome is available in three variants:

- **ISD** in clear polycarbonate
- **ISD** in opaque polycarbonate
- **ISD ----- 2093**, plane glass product. For CVP and CFP only (min roof pitch: 5°).

Various sunscreening products are available, such as:

- Awning blind MSG for exterior installation
- Mains-powered pleated blind FMG
- Solar-powered pleated blind FSK

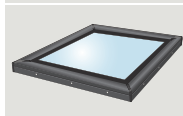
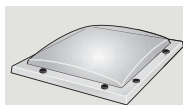
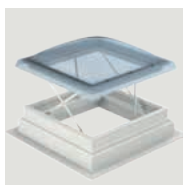
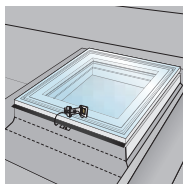
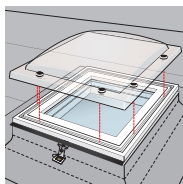

## Other products

### Flat roof window

Installation hints:

The design of the frame makes triangular lists unnecessary when installing in roofing felt.

The window frame is covered by adhering the roofing material to it.

Avoid direct contact between open burner flame and kerb!

If the installation requires mechanical fixing of the roofing material to the window frame, VELUX securing kit ZZZ 210 can be used.

If the installation height needs to be increased, use VELUX extension kerb ZCE 0015. The extension kerb increases the installation height by 160 mm. If the installation height needs to be increased even more, additional extension kerbs can be used on top of each other. In that case, use variant ZCE 1015 (160 mm).

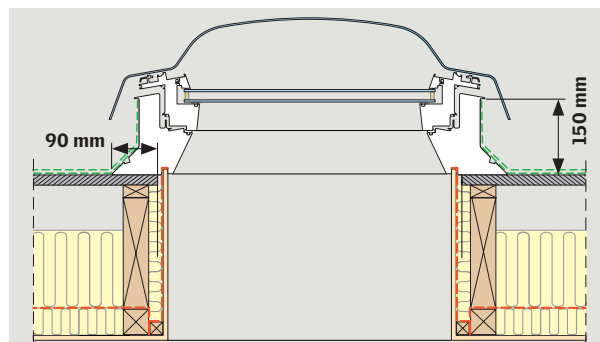
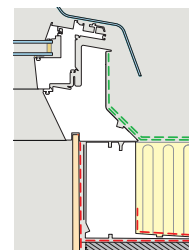
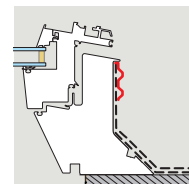
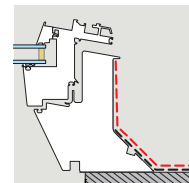

## Other products

### Modular skylights

VELUX modular skylights is a modular rooflight system for commercial buildings.

The modular skylight system consists of pre-fabricated modules, is delivered as a complete installation kit with flashing and is to be installed on a prepared sub-construction (not included in the VELUX delivery).



#### MODULAR SKYLIGHTS HFC AND HVC

The modular skylight system consists of:

- VELUX fixed modular skylights HFC
- VELUX venting modular skylights HVC (with integrated motor)
- flashing and covers for the chosen installation

The modules are made of glass fibre composite and provided with low energy glazing. Mains-powered roller blinds in a selection of colours can be fitted.

#### Control system for modular skylight HVC

VELUX modular skylight HVC can both be included in stand-alone systems with VELUX INTEGRA® products (based on the io-homecontrol® technology) or be connected to BMS systems such as MotorLink™ from WindowMaster.

In addition, certain sizes of HVC are approved for smoke ventilation.

## Other products

### Modular skylights

#### Installation principle

The skylight modules can be installed in different ways. Depending on the design of the sub-construction, these are:

- Longlight – installation angle 5° to 25°
- Ridgelight – installation angle 25° to 40°
- Ridgelight with beam – installation angle 5°
- Northlight – installation angle 40° to 90°

There is one factor common to all solutions: The sub-construction must be stable and designed to absorb the load from the modular skylights. In addition, the sub-construction must be dimensioned and built for the individual project.

Position the modular skylights and fix them to a steel profile by means of the clamp system supplied. Insulate sub-construction and fix flashing and cover parts.

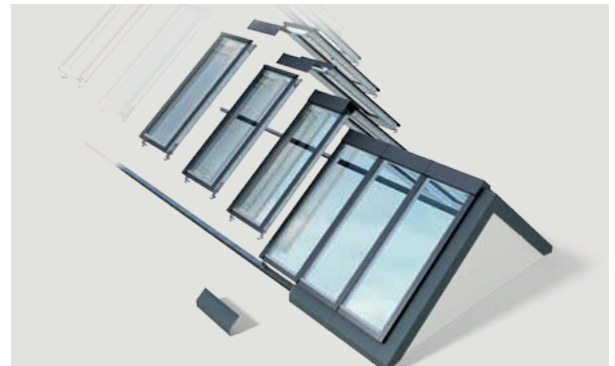
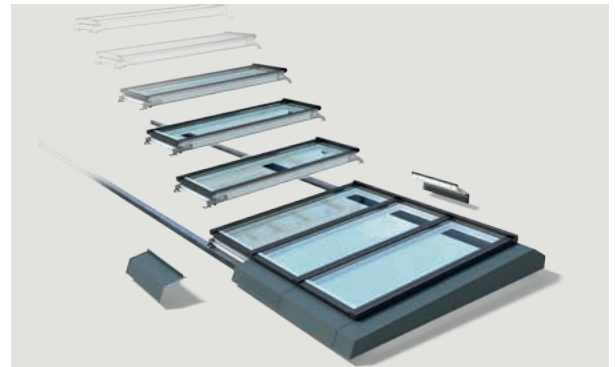



# Contact VELUX Company Ltd

## Addresses / Service

---

VELUX Company Ltd sells and markets VELUX products on the British and Irish markets.



**Offices** and **showrooms** are situated at the addresses below:

VELUX Company Ltd  
Newark Road North  
Glenrothes  
Fife  
Scotland  
KY7 4NT

VELUX Company Ltd  
Unit 1, Willsborough Cluster  
Willsborough Industrial Estate  
Clonshaugh  
Dublin 17  
Ireland

# Contact VELUX Company Ltd

## Addresses / Service

---

### Technical Support

Telephone:  
01592 778 225 (UK)  
01 848 8775 (ROI)

Fax:  
0870 380 9395 (UK)  
01 848 8787 (ROI)

E-mail:  
[technical@velux.co.uk](mailto:technical@velux.co.uk)  
[technical@velux.ie](mailto:technical@velux.ie)

### Service Support

Telephone:  
01592 778 225 (UK)  
01 848 8775 (ROI)

Fax:  
0870 401 7961 (UK)  
01 848 8557 (ROI)

E-mail:  
[service@velux.co.uk](mailto:service@velux.co.uk)  
[service@velux.ie](mailto:service@velux.ie)

### Training Centres

Situated in Glenrothes and Dublin

Telephone:  
01592 778 925 (UK)  
01 816 1617 (ROI)

E-mail:  
[training@velux.co.uk](mailto:training@velux.co.uk)  
[training@velux.ie](mailto:training@velux.ie)

**List of telephone numbers**

---

**Notes**

---

<b>Technical Support (UK)</b>	<b>01592 778 225</b>
<b>Technical Support (ROI)</b>	<b>01 848 8775</b>
<b>Service Support (UK)</b>	<b>01592 778 225</b>
<b>Service Support (ROI)</b>	<b>01 848 8775</b>

# Size charts

## Flat roof windows

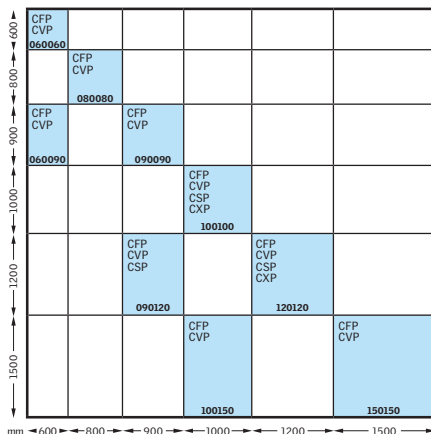

## Modular skylights

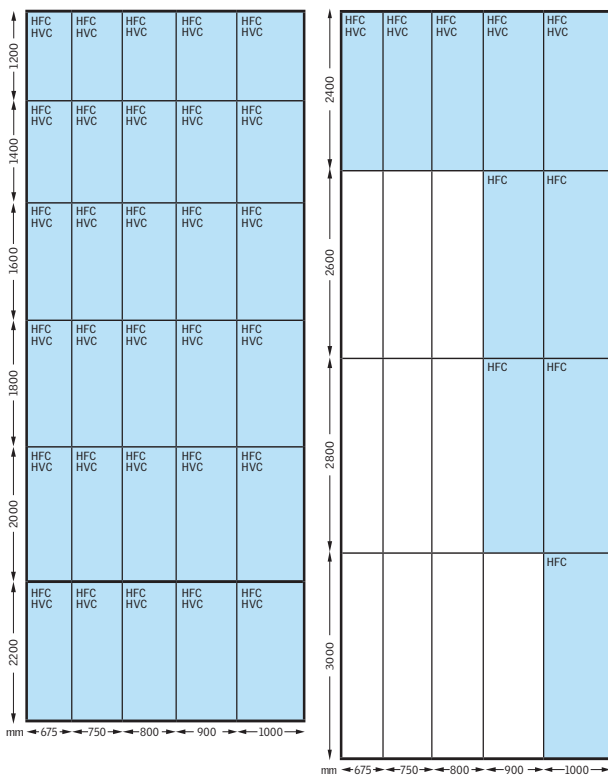

# Size charts

## Roof windows

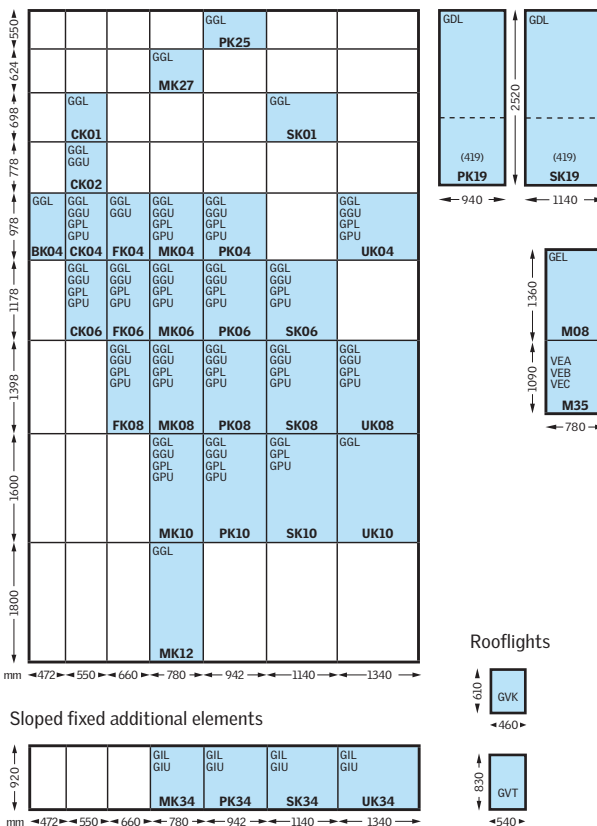

## Rooflights

## Sloped fixed additional elements

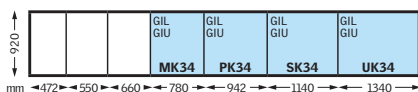

## Vertical window elements

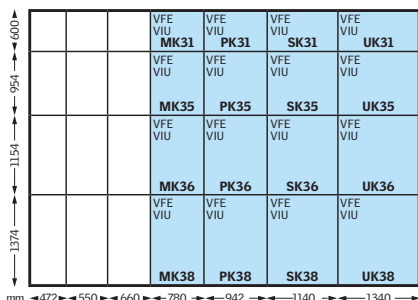

## Sun tunnels

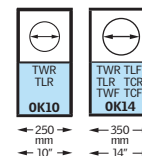

Not all variants of insulating glass units are available for all window types and sizes. Please visit [www.velux.co.uk](http://www.velux.co.uk) or [www.velux.ie](http://www.velux.ie) for further information.



VELUX Company Ltd  
Newark Road North  
Glenrothes  
Fife  
Scotland  
KY7 4ND

VELUX Company Ltd  
Unit 1, Willsborough  
Cluster  
Willsborough Industrial  
Estate  
Clonsaugh  
Dublin 17  
Ireland

*Bringing light to life*

**VELUX®**